

NAS vehicles

1.

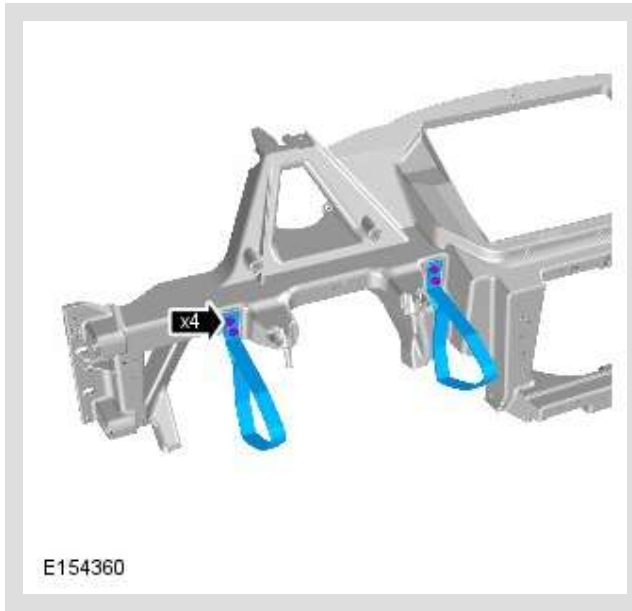

*Torque: 9 Nm*

## INSTALLATION

1. To install, reverse the removal procedure.

2015.0 F-TYPE (X152), 501-12

INSTRUMENT PANEL AND CONSOLE

**INSTRUMENT PANEL** (G1717103)

## REMOVAL AND INSTALLATION

76.46.01

FASCIA  
BOARD -

ALL

2.6

USED

## REMOVAL

 NOTES:

- Removal steps in this procedure may contain installation details.
- LHD illustration shown, RHD is similar.

All vehicles

1.

 NOTE:

Repeat the procedure for the other side.

Refer to: [Front Seat - Vehicles With: Sports Seats](#) (501-10 Seating, Removal and Installation).

Refer to: [Front Seat - Vehicles With: Performance Seats](#) (501-10 Seating, Removal and Installation).

2.

 NOTE:

Repeat the procedure for the other side.

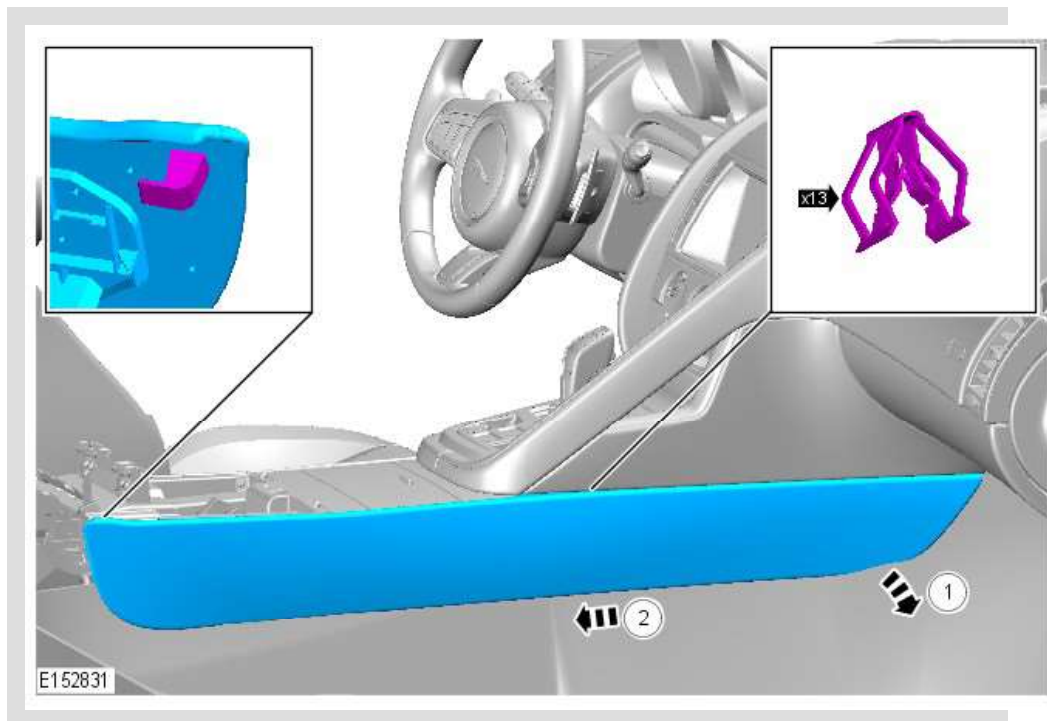

3. Refer to: [Side Vent](#) (412-01 Climate Control, Removal and Installation).

4. Refer to: [Touch Screen](#) (415-01 Information and Entertainment System, Removal and Installation).

5. Refer to: [Instrument Cluster](#) (413-01 Instrument Cluster, Removal and Installation).

6. Refer to: [A-Pillar Trim Panel - Folding Top](#) (501-05 Interior Trim and Ornamentation, Removal and Installation).  
Refer to: [A-Pillar Trim Panel - Coupe](#) (501-05 Interior Trim and Ornamentation, Removal and Installation).

7.

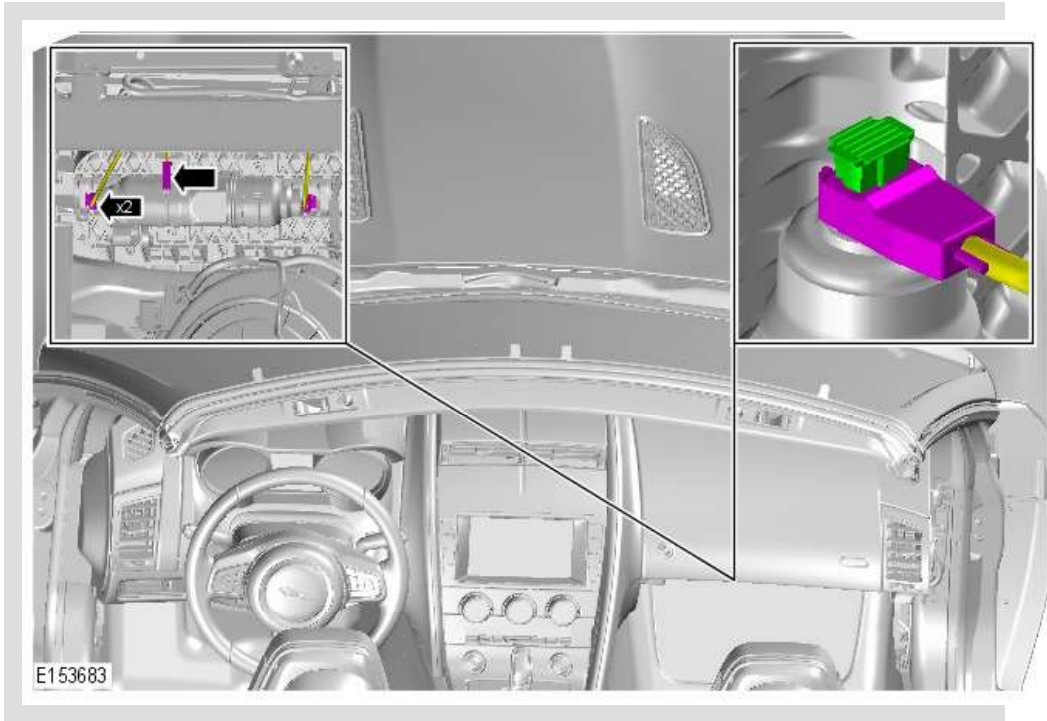

8.

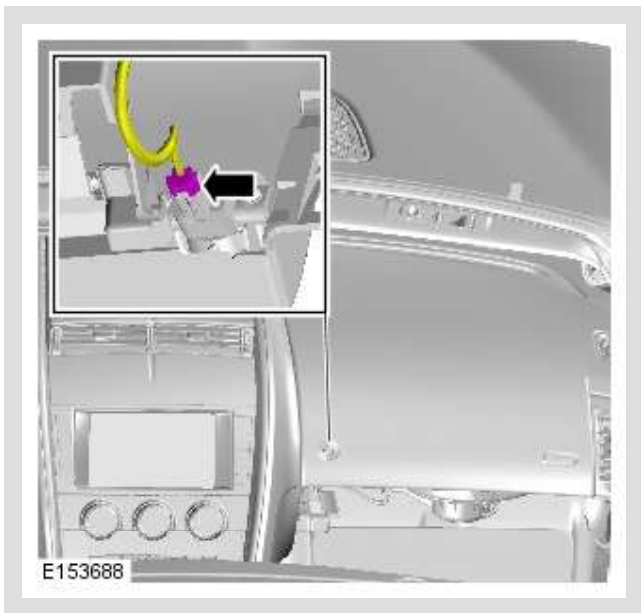

9.

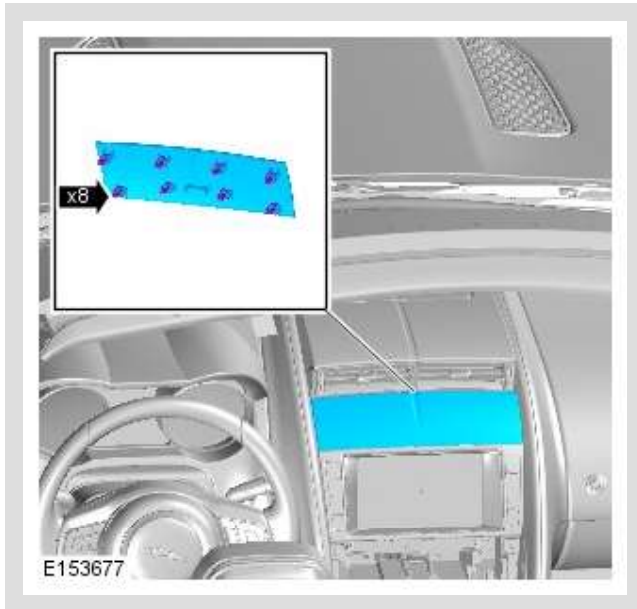

10.

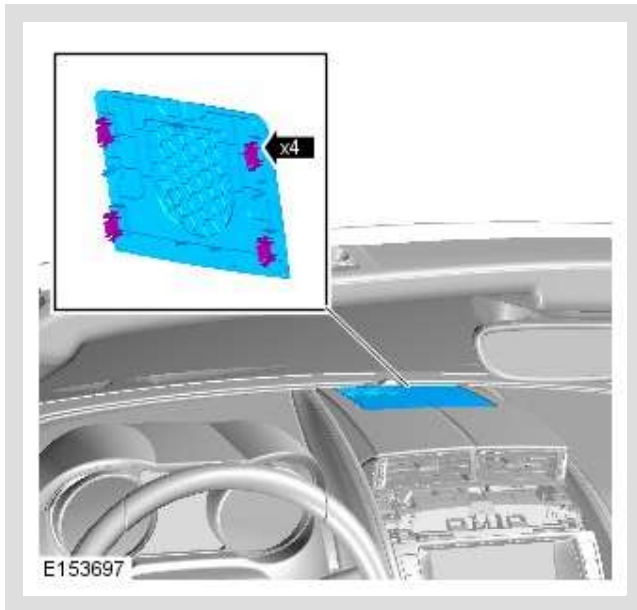

11.

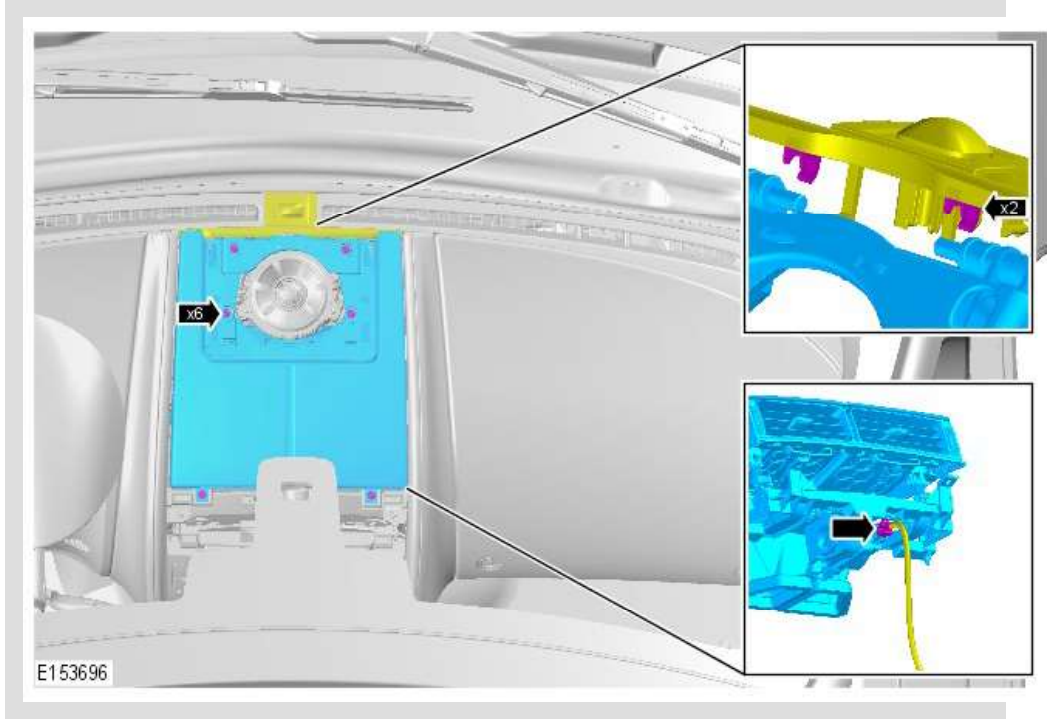

12.

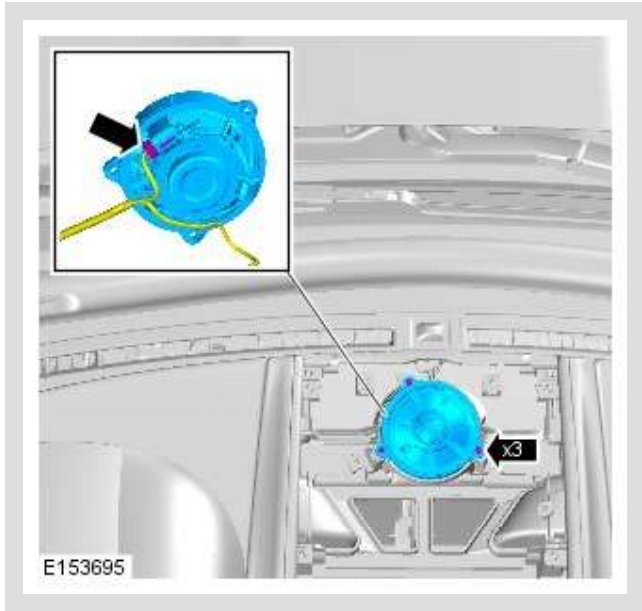

13.

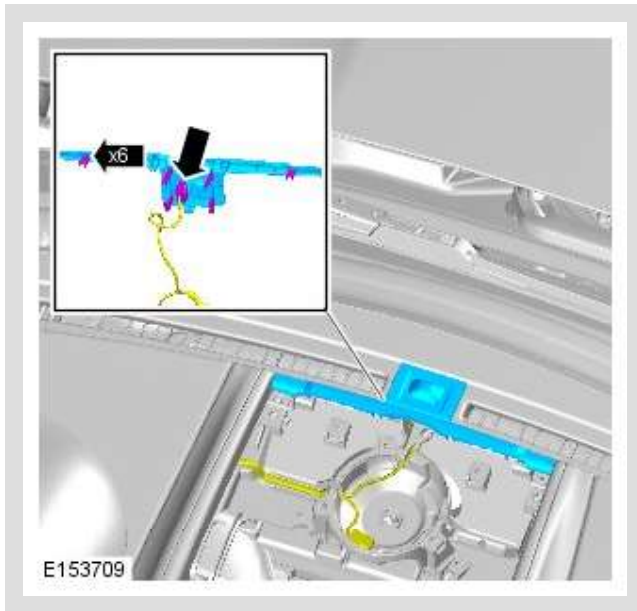

14.

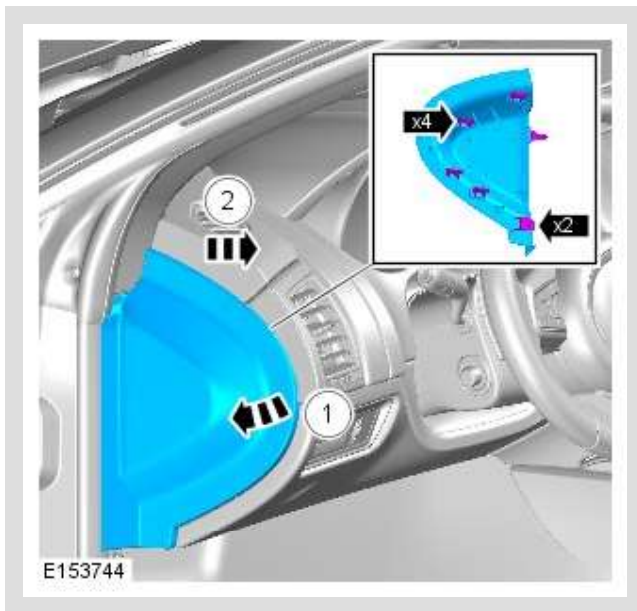

15.

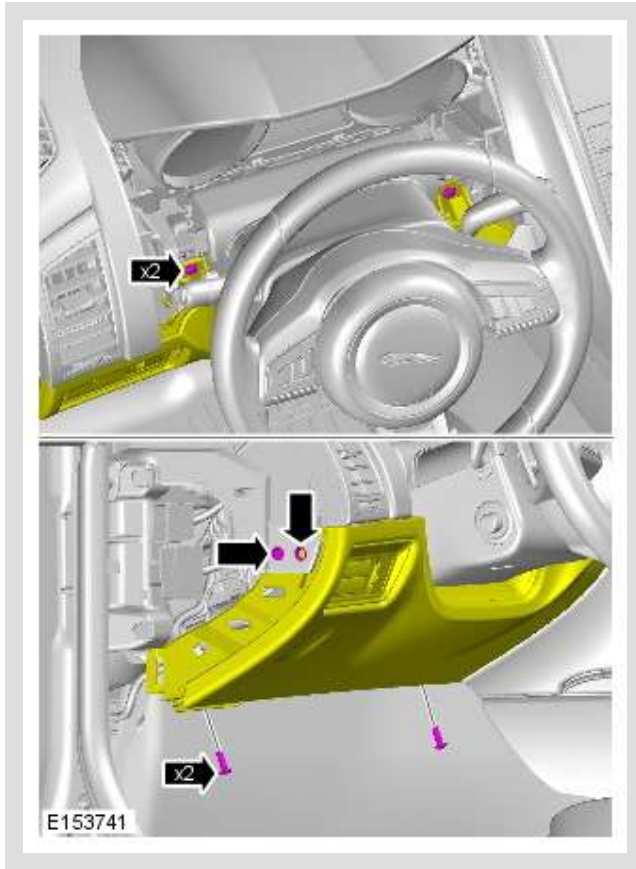



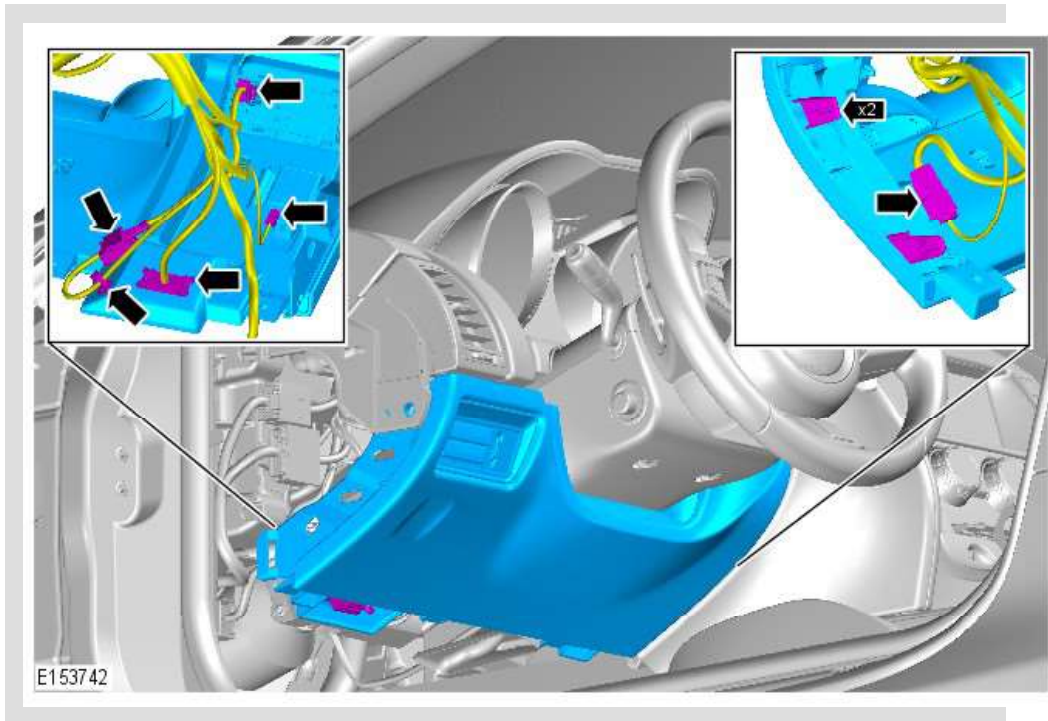



18.

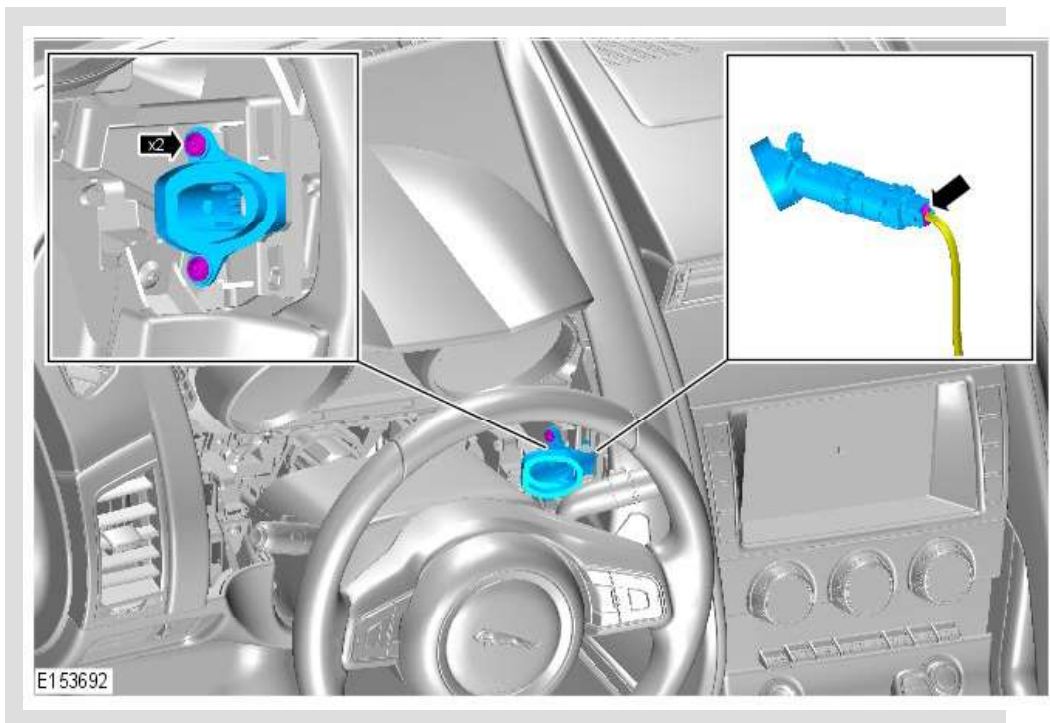

19.

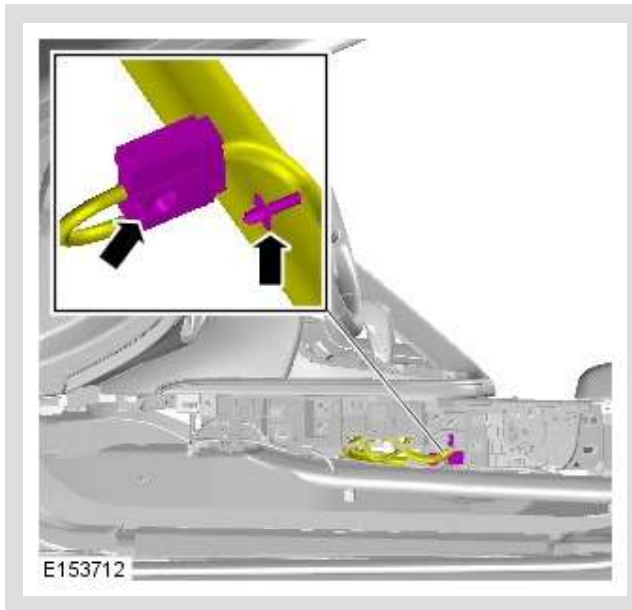

Vehicles with automatic transmission

1.

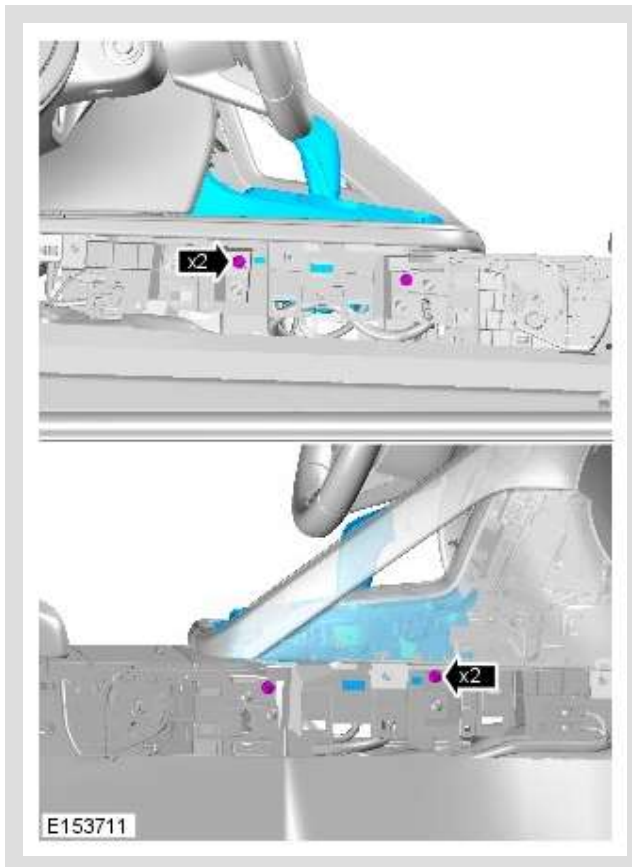

Vehicles with manual transmission

1.

**⚠ WARNING:**

The selector lever knob will be released suddenly, keep face clear during removal.



2.

**⚠ CAUTION:**

Care must be taken to avoid damaging the surrounding components.



3.

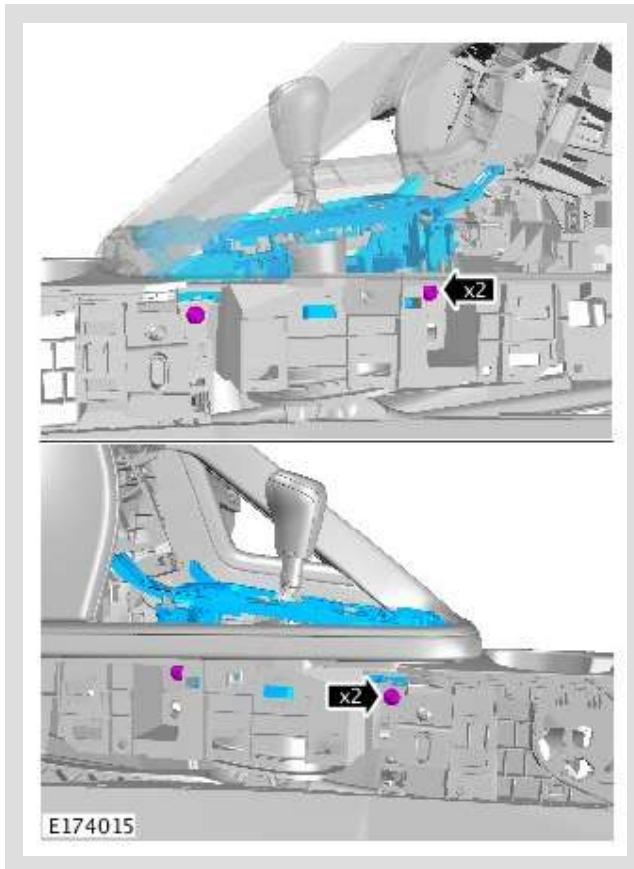

All vehicles

1.

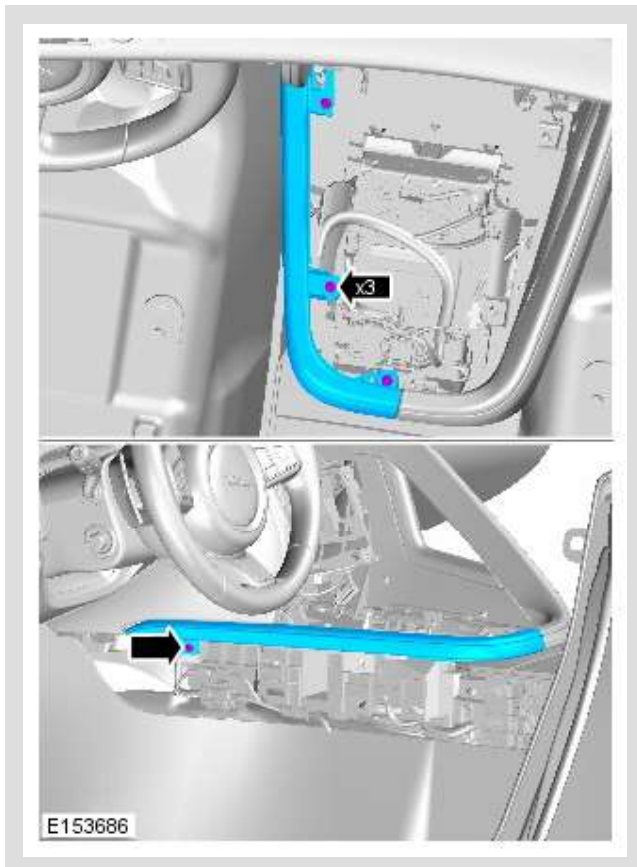

2.

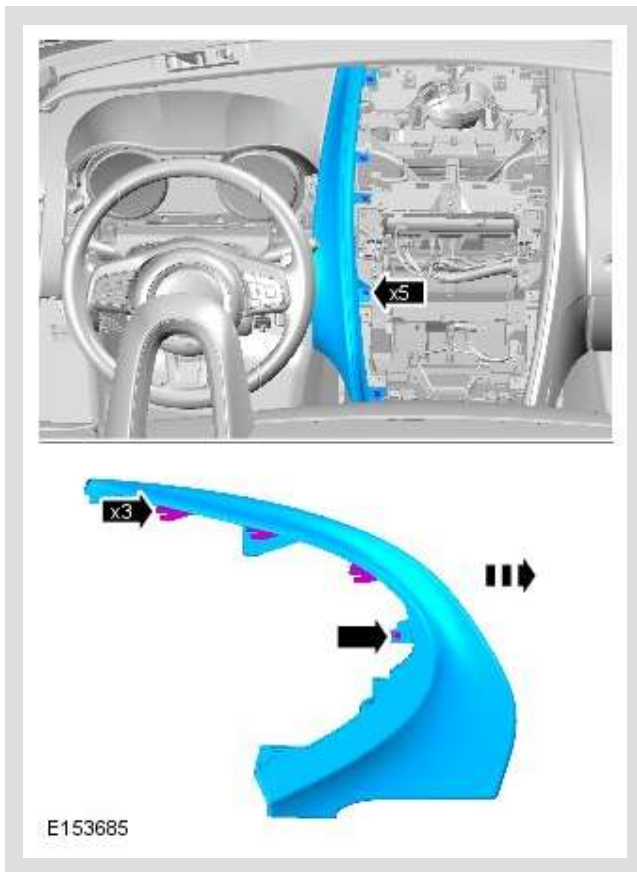



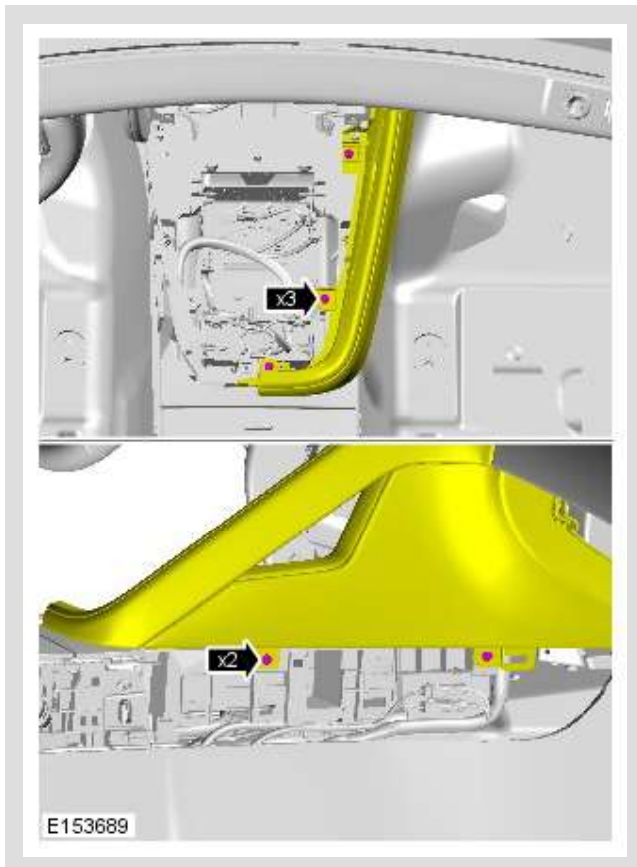

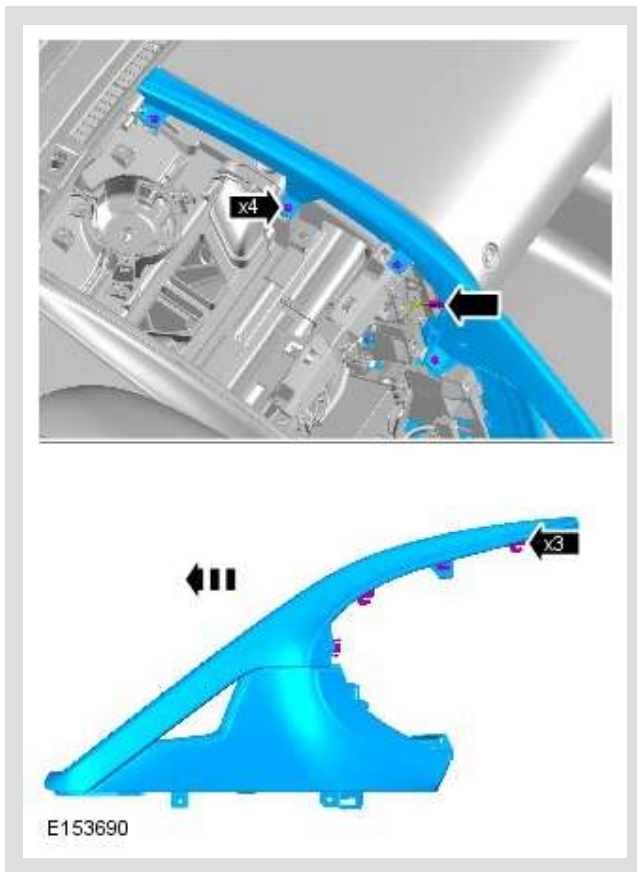

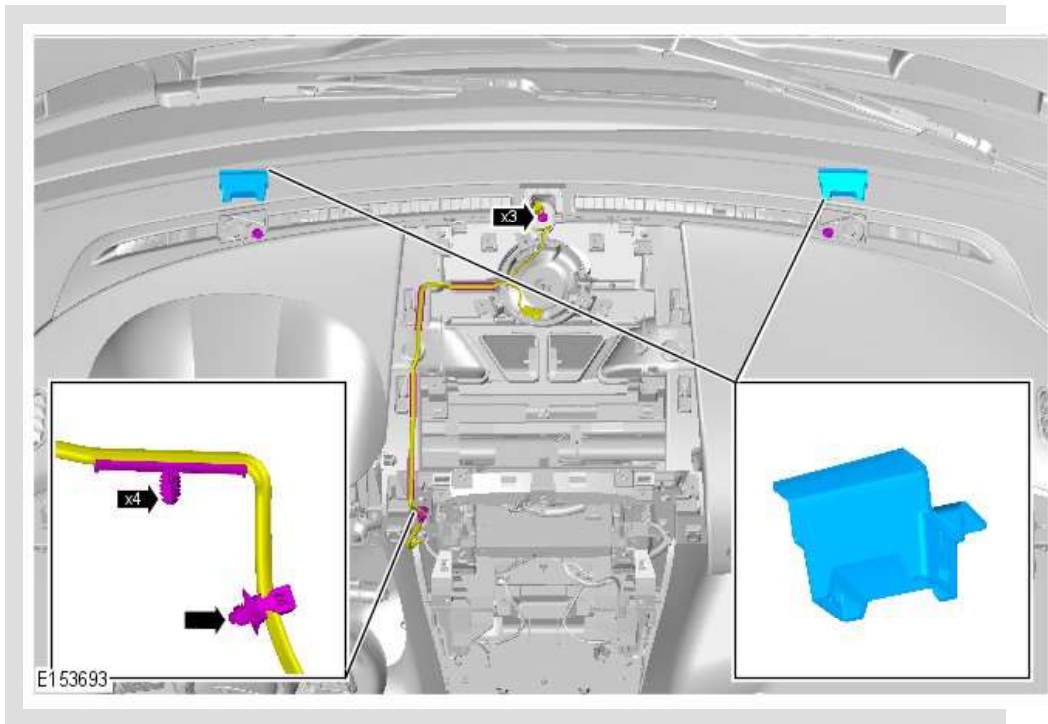

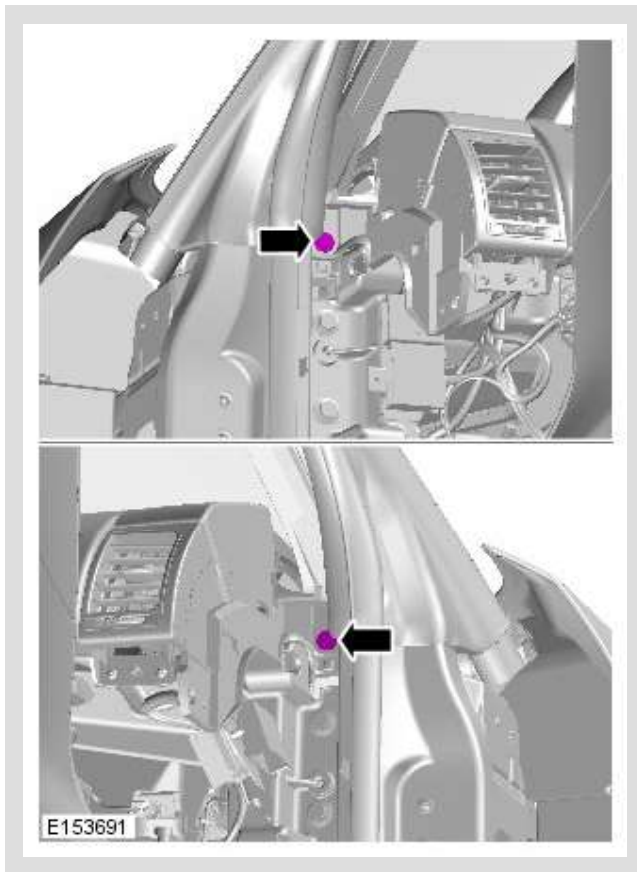

*Torque: 9 Nm*