



MODEL
XJ, S-TYPE,
X-TYPE

DATE
24 AUG 2007

NUMBER
JTB00055

SERVICE

TECHNICAL BULLETIN

THIS BULLETIN REPLACES ALL VERSIONS OF ST211-004, XJ211-001, XT211-001

SECTION: 211-00

Power Steering System Squeaking Noise Repair Procedure

AFFECTED VEHICLE RANGE:

S-TYPE	VIN: M45255 Onwards
	Model Year: 2003 Onwards
XJ Range	VIN: G00442 Onwards
	Model Year: 2004 Onwards
X-TYPE	VIN: C00294 Onwards
	Model Year: 2002 Onwards

CONDITION SUMMARY:

POWER STEERING SYSTEM SQUEAKING NOISE

Situation: On some S-Type, X-Type and XJ Range vehicles within the VIN ranges above, a squeaking noise may be apparent from the power assisted steering system when the steering wheel is rotated in either direction. The noise is caused by a seal inside the steering rack. The noise can be transmitted through the steering column and steering wheel, making it difficult to diagnose. This bulletin does not address any other PAS noises, such as pump or drive belt related noises.

Action: In the case of a verified customer complaint matching the description above, refer to the Repair Procedure detailed in this bulletin and complete the service fix.

PARTS:

C2S 48887Fluid additive Qty 1

WARRANTY:

 **NOTE:** Repair procedures are under constant review, and therefore times are subject to change; those quoted here must be taken as guidance only. Always refer to DDW to obtain the latest repair time.

DDW requires the use of causal part numbers. Labor only claims must show the causal part number with a quantity of zero.

Description	SRO	Time (Hours)	Condition Code	Causal Part
PAS Squeak/Fluid Additive	57.91.29/01	0.2	42	C2S 48887

Normal warranty policy and procedures apply.

NOTE: The information in Technical Bulletins is intended for use by trained, professional technicians with the knowledge, tools, and equipment required to do the job properly and safely. It informs these technicians of conditions that may occur on some vehicles, or provides information that could assist in proper vehicle service. The procedures should not be performed by "do-it-yourselfers." If you are not a Retailer, do not assume that a condition described affects your vehicle. Contact an authorized Jaguar service facility to determine whether the bulletin applies to a specific vehicle.

REPAIR PROCEDURE

PAS SQUEAK/FLUID ADDITIVE



NOTE: SSM 34548 contains a video clip showing the repair outlined in this bulletin to aid understanding of the procedure.

1. Open driver's door.
2. Ensure the gear lever is in either neutral or park, the parking brake is 'ON', and the ignition is 'OFF'.
3. Open hood and install fender protectors.
4. Remove the power steering fluid reservoir cap (and filter mesh on XJ and S-Type vehicles) and ensure the fluid level is correct. (Figure 1)
5. Using a suitable clean syringe, remove 50ml of steering fluid.



NOTE: The fluid additive must only be added once and the supplied label must then be affixed to the power steering fluid reservoir.

6. Replenish the power steering fluid reservoir with 50ml of the specified fluid additive (C2S 48887).
7. Affix the supplied label to the power steering fluid reservoir



NOTE: Suitable temperature reading equipment must be positioned into the power steering fluid reservoir, (filter mesh must be removed on XJ and S-Type vehicles) and that the temperature can be read while carrying out the heating process.

8. Insert the temperature reading equipment probe into the power steering fluid reservoir (about halfway into the depth of the fluid).

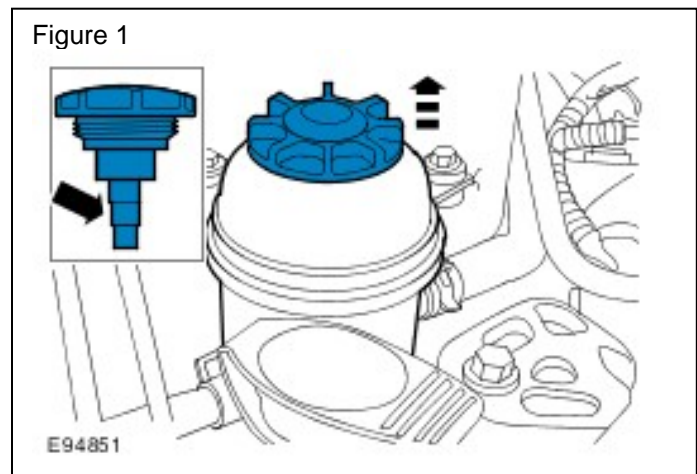

HEATING THE STEERING FLUID TO 100°C ±5°C (212°F±10°F)

1. Turn ignition 'ON' and start the engine.
2. With the engine idling, turn the steering wheel from lock to lock four times to cycle the fluid additive into the system. (Figure 2)

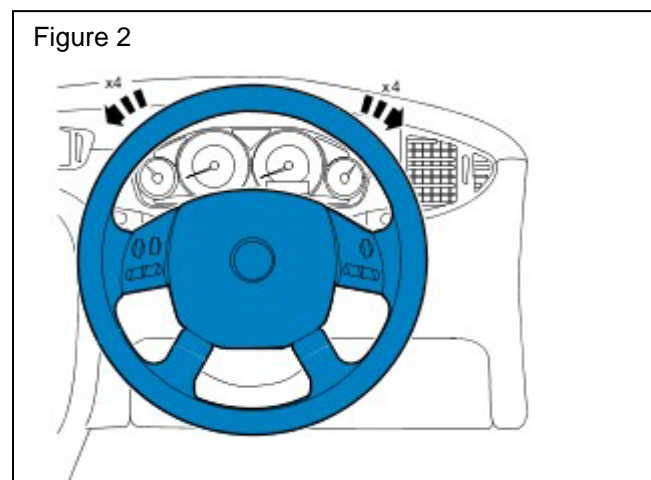

 **CAUTION:** Under no circumstances hold the steering wheel on full lock while heating the steering fluid (to avoid damage to the steering system).

 **CAUTION:** While carrying out the following procedure, ensure that 105°C (221°F) is not exceeded.

3. While stationary and with the steering wheel in the center position (road wheels in the straight ahead position), turn the steering wheel 90° (quarter turn) right and hold firmly with both hands. (Figure 3)

- Increase the engine speed to 3000rpm.
- Monitor the power steering fluid temperature until 100±5°C (212°F±10°F) is reached.

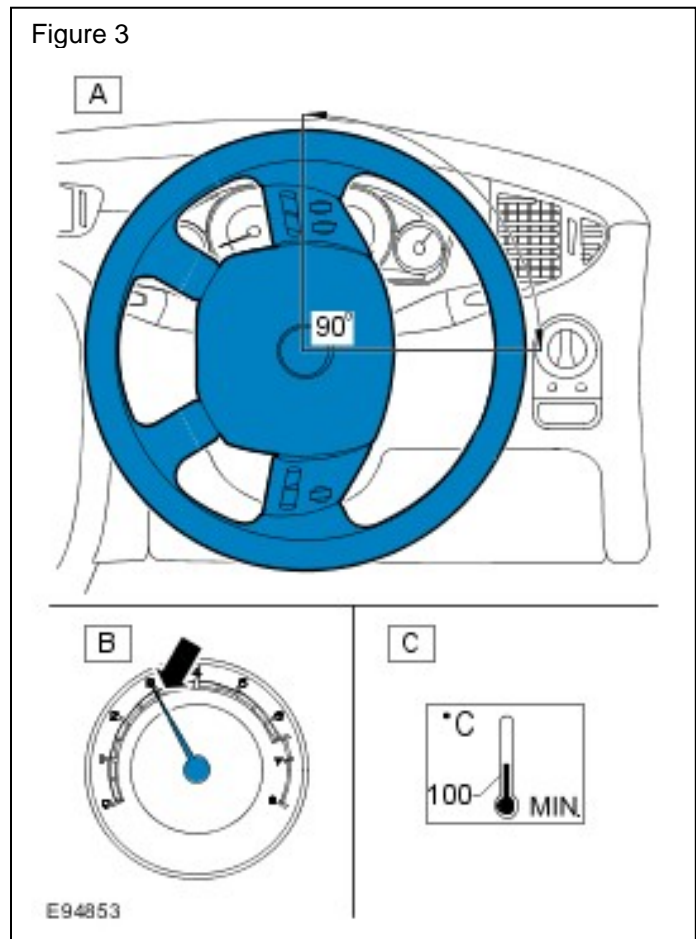

PERFORMING THE STEERING MANEUVER

 **NOTE:** The steering maneuver should be carried out on a hard flat surface outside of the workshop.

 **CAUTION:** Do not hold the steering wheel on full lock for more than two seconds as this may cause damage to the steering system.

1. Verify the power steering fluid temperature is at $100\pm 5^{\circ}\text{C}$ ($212^{\circ}\text{F}\pm 10^{\circ}\text{F}$), engine idle speed set between minimum 900rpm and maximum 1000rpm.
2. Turn the steering wheel to full lock and hold for two seconds.
3. From full lock turn the steering wheel quickly and rapidly back a quarter (90°) turn (refer to SSM 34548 showing this procedure). (Figure 4)
4. Repeat steps 2 and 3 eight times.
5. Turn the steering wheel to the opposite full lock, and repeat steps 1 and 2.
6. Remove the temperature reading equipment from the power steering fluid reservoir.
7. Install the power steering fluid reservoir cap, remove fender protectors, and close hood.
8. Road test the vehicle and check for a squeaking noise from the power steering system.

 **NOTE:** If the vehicle continues to exhibit a squeak after the road test, carry out the 'Heating the steering fluid to $100\pm 5^{\circ}\text{C}$ ' ($212^{\circ}\text{F}\pm 10^{\circ}\text{F}$) (Steps 1, 2 & 3) and 'Performing the steering maneuver' (Steps 2 3 & 4) to a maximum of two additional times. If further problems occur, contact Dealer Technical Support on 888-524-3577 (888 JAG DLRS)

