S-Type 2003 MY NAS Driver's Handbook



Jaguar S-TYPE Driver's Handbook

JAGUAR CARS LIMITED, as manufacturer, is dedicated to the design and production of vehicles which meet the expectations of the world's most discerning purchasers.

This handbook forms part of the owner literature supplied with your vehicle. It is designed to complement the relevant features and systems of the vehicle, and make them easy to understand and operate.

The information contained in this handbook applies to a range of vehicles and not to a specific vehicle. For the specification of a particular vehicle, owners should consult their Jaguar Dealer.

The manufacturer reserves the right to vary its specifications with or without notice, and at such times and in such manner as it thinks fit. Major as well as minor changes may be involved in accordance with the Manufacturer's policy of constant product improvement.

To cover changes, it is sometimes necessary to issue one or more handbook supplements. When reading this handbook, check the owner literature for possible supplements.

For full details of the owner literature originally supplied with the vehicle, owners should consult their Jaguar Dealer.

All rights reserved. No part of this publication may be reproduced, stored in a retrieval system or transmitted, in any form, electronic, mechanical, photocopying, recording or other means without prior written permission from the Service Division of Jaguar Cars Limited.

Contents

1. Owner information

General information	1-1
Warnings, Cautions and Notes	1-2
Health and safety	1-3
Regular servicing.	1-4
Jaguar diagnostic system	1-4
Vehicle identification	1-5
Protect the environment.	1-6
Mobile/portable telephones	1-6
Window tinting.	1-6
Touch-screen display	1-7
JaguarNet Telematics system.	1-10
Before using the system.	1-10

2. Security and locks

Ignition switch	2-1
Vehicle security.	2-2
Immobilisation system.	2-2
Key transmitter	2-3
Door locks and handles.	2-5
Child safety locks.	2-5
Vehicle locking and unlocking.	2-6
Alarms and audible signals	2-11
Security features	2-12
HomeLink® Universal Transceiver.	2-13

3. Before driving

Occupant protection	3-1
Seat belts	3-1
Airbags	3-3
Child safety	3-12
Seat adjustment.	3-16
Steering column adjustment	3-18
Pedal Adjustment	3-19
Window operation	3-20
Window anti-trap protection	3-21
Mirrors	3-22
Door rear view mirrors	3-22
Interior rear view mirror	3-23
Memory setting	3-24
Luggage compartment	3-26

4. On the road

Instruments.	4-1
Warning lights	4-2
Audible warnings	4-7
Message centre	4-8
Messages	4-9
Trip computer	4-16
Cruise (speed) control	4-18
Adaptive cruise control (ACC)	4-20
Exterior lighting.	4-26
Rear sun blind	4-29

4. On the road (continued)

Interior lighting	4-31
Reverse park control	4-32
Horn	4-32
Sunroof	4-33
Wipers and washers	4-34
Parkbrake	4-36
Interior features	4-37
Sun visors and vanity mirrors	4-38
Cigar lighter and ashtray	4-38
Rear cup holders	4-38
Glove compartment	4-39
Starting/stopping the vehicle	4-40
Automatic transmission	4-42
Gearshift interlock	4-42
Gear selector positions	4-42
Sport mode	4-44
Manual transmission	4-44
Anti-lock braking system (ABS)	4-45
Traction control	4-47
Dynamic stability control (DSC)	4-48
General driving information	4-49
Winter driving	4-50
Touring	4-51
Towing a caravan or trailer	4-52
Fuel and refuelling	4-53

5. Climate control

Introduction	5-1
Automatic climate control with LCD screen	5-4
Automatic climate control with touch screen	5-8

6. Roadside emergency

Inertia switch	6-1
Emergency starting	6-2
Wheel changing and jacking	6-4
Vehicle recovery	6-8
Towing eye	6-10
Bulb renewal	6-11
Fuses and fuse boxes	6-17
Fire extinguisher	6-34

7. Maintenance

General maintenance	7-1
Hood release	7-3
Regular checks	7-4
Checking and top up	7-7
Capacities	7-13
Battery	7-14
Windscreen wipers	7-17
Tyres	7-18
Vehicle care	7-21
Interior care	7-21
Exterior care	7-22
Electrical accessories	7-24

Contents

8. Specifications

Vehicle data	8-1
Weights (average/approximate)	8-2
Roof-rack capacity and trailer weights	8-3
Wheels and tyres	8-4
Tyre pressures	8-5
Tow-bar fixing points	8-6

A comprehensive index is located at the back of this Handbook.

General information

Whether you are new to the Jaguar marque or have previously owned Jaguar or Daimler vehicles, we are pleased that you have made Jaguar your choice of vehicle this time.

For safety and the pleasure you will get from your new vehicle, please take the time to get well acquainted with your vehicle by reading the handbooks.

Details of the vehicle warranty are contained within the 'Passport to Service' booklet for USA and Canada or, for Mexico, the 'Service Record and Warranty' book.

When left-hand or right-hand is used in the text, this refers to the left-hand side or right-hand side of the vehicle, viewed from the rear.

This Handbook describes every option and model variant available and therefore some of the items covered may not apply to your particular vehicle.

Jaguar Dealers

Jaguar Dealers are chosen with care. Each is dedicated to providing a Sales, Service and Spare Parts facility of the highest standard.

Jaguar Dealers are provided with full technical support from the factory, with comprehensive training for all their technicians. Dealers' workshops operate to a high standard and have all the necessary tools and equipment essential to maintain or repair Jaguar vehicles.

A current list of Dealers is included in the vehicle literature pack.

Genuine Jaguar parts and accessories

Your Jaguar Dealer can supply you with genuine replacement parts and accessories which are fully approved to Jaguar's original equipment specification. This will ensure that the safety and performance of your vehicle is maintained for your complete peace of mind.

Please note that fitment of non-genuine parts may invalidate the vehicle warranty if a subsequent fault occurs due to fitting sub-standard replacement parts or accessories.

Jaguar parts distribution service

Jaguar Dealers stock a large number of parts to keep your vehicle maintained and back on the road as quickly as possible. Their service is backed-up by Jaguar's central parts warehouse in Coventry, England, providing next day delivery to most of Europe's Dealers and world-wide within two to three days.

Accessories

A full range of Jaguar Engineering approved accessories including safety, stowage, touring, leisure and lifestyle products are just some of those available from your Jaguar Dealership.

Please ask your Jaguar Dealer for an up-to-date brochure so you can select your requirements from the latest range.

1-2 Owner information

Warnings, Cautions and Notes

Take particular note of WARNINGS, Cautions and Notes given throughout this handbook.



WARNING:

A warning is a procedure which must be followed precisely to help avoid the risk of personal injury.

Caution: A caution is a procedure which must be followed precisely to reduce the possibility of damage to the vehicle and resultant risk of personal injury or inconvenience.

Note: A note is a procedure which will help avoid difficulties in the operation of the vehicle.

Vehicle Handbooks



WARNING:

Remember to pass on the Vehicle Handbooks when reselling the vehicle. Handbooks are integral parts of the vehicle.

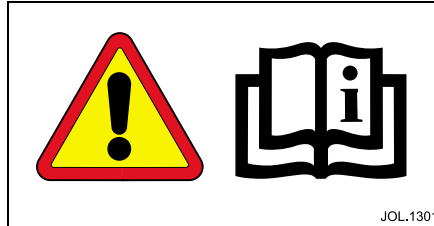

Warning symbols on the vehicle

On encountering the warning triangle or open book symbol on the vehicle, it is important that before touching this part of the vehicle or attempting adjustments of any kind you consult the relevant section of this handbook.

Caution: Do not remove any warning labels from the underhood area or inside the vehicle.

Vehicle Handbooks

If you believe that your vehicle has a defect which could cause a crash or could cause injury or death, you should immediately inform the National Highway Traffic Safety Administration (NHTSA) in addition to notifying Jaguar Cars.

If NHTSA receives similar complaints, it may open an investigation, and if it finds that a safety defect exists in a group of vehicles, it may order a recall and remedy campaign.

However, NHTSA cannot become involved in individual problems between you, your Dealer, or Jaguar Cars.

To contact NHTSA, you may either call the Auto Safety Hotline toll-free at 1-800-424-9393 (or 366-0123 in Washington, D.C. area) or write to:

NHTSA, U.S. Department of Transportation, Washington, D.C. 20590.

To contact Jaguar Cars, call 1-800 4 Jaguar.

You can also obtain other information about motor safety from the Hotline.

Health and safety



WARNING:

1. Many liquids and other substances used in vehicles are poisonous and should never be consumed and must be kept away from open wounds. These substances include anti-freeze, brake fluid, fuel, windscreen washer additives, lubricants and various adhesives.
2. The presence of any unusual fumes (for example, petrol or exhaust fumes) in the passenger compartment and/or luggage compartment should be corrected immediately by a Jaguar Dealer. If you must drive under these conditions do so only with all windows fully open.
3. By operating other electronic equipment (for example, a mobile phone without an exterior antenna) electro-magnetic fields can cause malfunctions of the vehicle electronics. Therefore, you should observe the instructions of the equipment manufacturers.
4. Any modifications to the fuel system not specifically designed for this Jaguar are prohibited. Such modifications in some circumstances could result in a fire. All service actions must be entrusted to a Jaguar Dealer.
5. Alterations to the electrical system, including the fitting of accessories not designed for this Jaguar, will cause damage to the electrical circuits and systems. In some circumstances this could result in a malfunction or fire. All accessory work should be entrusted to a Jaguar Dealer.
6. No attempt should be made to repair a fuse that has blown. Always install a new fuse of the correct amperage. Failure to comply with the above may cause a fire hazard or create serious damage elsewhere in the electrical circuit.
7. Avoid contact with battery acid which is poisonous and corrosive. Acid will cause burns to the skin as well as to the eyes. In the event of skin or eye contamination, wash the affected area with water thoroughly.
8. Do not disconnect any pipes in the air conditioning refrigeration system. A refrigerant is used which can cause blindness if allowed to contact the eyes. If refrigerant should contact the eyes or skin, wash the eyes or affected area with cold water for several minutes. Do not rub. As soon as possible thereafter, obtain treatment from a doctor or eye specialist.
9. When working within the engine compartment, take care to avoid contact with moving parts and hot components, and ensure that any metal objects do not short circuit the battery.
10. California Proposition 65: Engine exhaust, some of its constituents and certain vehicle components, contain or emit chemicals known to the State of California to cause cancer and birth defects or other reproductive harm.

Seek immediate medical attention when eye contact has occurred.

1-4 Owner information

Regular servicing

Each vehicle is given a full 'Pre-Delivery Inspection' to ensure that all systems function correctly and that the vehicle meets its specification.

Owners are responsible for the regular maintenance and servicing of the vehicle. Jaguar Dealers will be pleased to arrange periodic servicing and can provide you with details of tasks carried out at each service interval.

Failure to implement maintenance at the recommended intervals could result in deterioration of vehicle performance and possible infringement of regulations.

Regular routine maintenance not only helps to prevent unnecessary 'breakdowns' and inconvenience, but enhances the 'trade in' or resale value of the vehicle.

USA and Canada

Jaguar Dealers will arrange for appointments on a mileage/distance or time interval basis to ensure that all routine and corrective maintenance work is undertaken and recorded in the 'Passport to Service' Booklet. This booklet not only contains a record of vital information, but also information about warranties, Jaguar Cars, Jaguar Car Clubs, Tyre Manufacturers and change of ownership or address vouchers.

Mexico

Jaguar Dealers will arrange for appointments on a mileage/distance or time interval basis to ensure that all routine and corrective maintenance work is undertaken and recorded in the Service Record and Warranty Book. This booklet not only contains a record of vital information, but also information about warranty and a change of ownership card.

Jaguar diagnostic system

Many of the vehicle systems are controlled by complex electronic devices. Specialist equipment is required to trace and rectify faults in the systems and ensure that only faulty components are repaired or renewed.

Caution: Severe damage to the electrical system and electronic components can occur if any attempt is made to diagnose faults in the electrical system using conventional diagnostic equipment (for example, the use of test lamps or low impedance voltmeters). The fitting of any electrical accessory should only be entrusted to a Jaguar Dealer.

Vehicle identification

Vehicle identification number (VIN)

It is essential that the Vehicle Identification Number (VIN) is quoted in all correspondence and when ordering replacement parts.

The number is visible from outside the vehicle, on a plate in the lower left edge of the windscreen.

Certification Label

Vehicles have the Certification Label adhered to the left-hand front door hinge post. Vehicle weights, paint code, manufacture date and the VIN are shown on this plate.

Engine number

V6: The number is located on the lower left-hand side of the cylinder block near the bedplate.

V8: The number is located on the rear left-hand side of the cylinder block, either adjacent to the transmission flange, or on the left-hand side web towards the rear of the cylinder block.

Transmission number

On a metal label or bar code label attached to the transmission casing.

Warranties (USA and Canada)

The 'Passport to Service' booklet contains warranties applicable to the vehicle, which include:

- The Limited vehicle Warranty.
- The Emission Control System Warranty and covered parts list.
- The Corrosion Warranty.

Tyres are not warranted by Jaguar Cars, but by the specific manufacturer of the tyres on the vehicle. Details of tyre warranties are included in the vehicle literature pack.

Warranties (Mexico)

The 'Service Record and Warranty' book contains warranties applicable to the vehicle, which include:

- The Limited vehicle Warranty.
- The Emission Control System Warranty and covered parts list.
- The Corrosion Warranty.

1-6 Owner information

Protect the environment

We must all play our part in protecting the environment. Correct vehicle usage and disposal of waste cleaning and lubrication materials are significant steps towards this aim.

Avoid using high engine speeds. You will then protect your engine, reduce fuel consumption, lower the engine noise level and help towards reducing the environmental burden.

Dispose of batteries, tyres, engine, brake and coolant fluids at your local authorised waste disposal facilities.

Mobile/portable telephones



WARNING:

Using a mobile/portable telephone without an exterior antenna is not recommended when driving as the electro-magnetic fields produced can cause malfunctions with the vehicle electronic systems.

Check the laws and regulations on the use of cellular telephones in the areas where you drive. Always obey them. Also, give full attention to driving.

Use hands-free operation (if fitted) and pull off the road and park before making or answering a call, if driving conditions so require.

Window tinting



WARNING:

Do not have your vehicle windows tinted with a metal oxide tinting (for maximum heat reduction from sun load) if you have a Navigation or JaguarNet system fitted to your vehicle.

Metal oxide tinting prevents the reception of the Global Positioning Satellite (GPS) signals by the antenna causing the navigation system to stop functioning.

This will also prevent the emergency JaguarNet feature from giving the emergency centre your vehicle location.

A non-metal tinting should be used if you require window tinting and if in doubt, contact your Jaguar Dealer for advice.

Touch-screen display

Touch-screen use and care

A touch-control screen is installed in certain vehicles and provides touch-control of vehicle climate, audio, navigation, television and telephone systems, as fitted. A small LCD screen below the touch-control screen provides digital display of the ambient temperature and vehicle cabin set temperature.

When the ignition switch is initially turned to position 'I' or 'II', the touch-control screen will display the Jaguar logo screen followed by activation and display of the mode previously used. Display of touch-controls for other systems can be obtained by pressing the appropriate perimeter button and these are described in the appropriate Handbook. Climate control operation is contained in Section 5 of this Handbook. Functions of the 'MENU' button are described on the following pages.



WARNING:

In the interests of road safety, do not attempt to use the touch-screen controls when driving.

Caution: Care must be taken to avoid spilling or splashing drinks onto the screen. In the event of such an occurrence advise your Jaguar Dealer.

Note: When operating touch-screen controls, always extend the tip of one finger, and withhold the thumb and remaining fingers from the screen.

The touch-screen and inner bezel must be kept clean to maintain optimum performance. Finger marks and attracted dust should be regularly removed using a soft cloth and a Jaguar approved cleaning agent.



Touch-control screen

1-8 Owner information



JOL1303Z

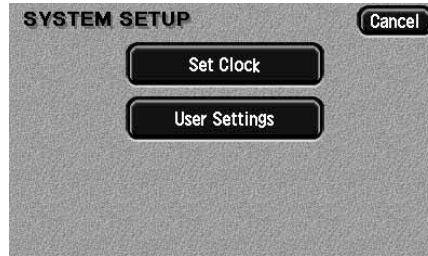

JOL1304Z

MENU

Pressing the 'MENU' perimeter button will display the system menu screen.

The screen display can be blanked out by touching the 'Screen Off' button.

Touch the screen, or any of the perimeter system selection buttons, to restore the display.

Alternatively, the Jaguar logo can be displayed by touching the 'Logo Screen' button.

Note:

1. 'TV' is only available in certain countries. If TV is available, see the accompanying Television Handbook for user instructions.
2. For details of the JaguarNet system (where fitted), see **JaguarNet Telematics system** on page 1-10.

SYSTEM SETUP

After touching the 'System Setup' button, the screen displays the touch-controls for setting the clock, and selecting user settings.

Note: Vehicles which have the Voice Activation system fitted will have an additional touch button on the system setup screen for voice training. This is described in the Voice Activation Handbook.

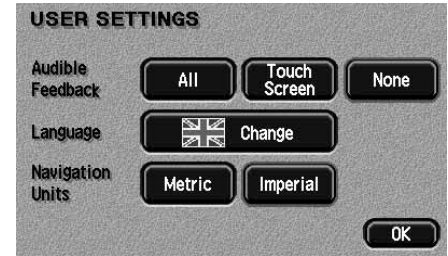

JOL1305Z

USER SETTINGS

After touching the 'User Settings' button, the screen displays the touch-controls for the selection of audible feedback, language, and units of measurement.

'All' selects audible feedback on the perimeter buttons and touch-controls.

'Touch Screen' selects audible feedback on the touch-controls only.

'None' selects no audible feedback.

To select another language, touch the 'Change' button and, if the language is not shown, scroll the screen as required. To select a language, touch the flag of the country required.

'Navigation Units' provides either imperial or metric units for use with the navigation system (where fitted).

Confirm your selection by touching 'OK'.

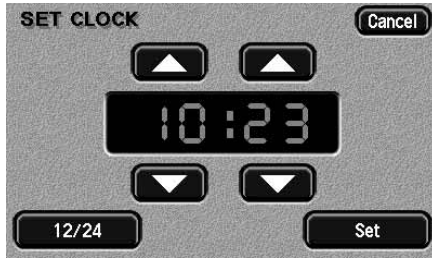

JOL.1306Z

SET CLOCK

Clock adjustment is made by touching the hour or minute, up or down arrow button.

Touch the '12/24' button to select twelve or twenty-four hour display.

Note: For vehicles not fitted with the touch-control screen, see the accompanying Audio System Handbook for the clock setting procedure.

Confirm your setting by touching 'Set'.

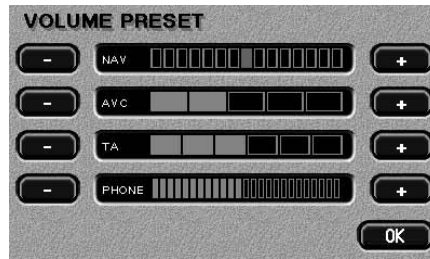

JOL.1307Z

VOLUME PRESET

After touching the 'Volume Preset' button, the screen displays the touch-controls for adjustment of volume associated with the navigation system, voice control, phone, traffic announcements and automatic volume control (AVC). Adjustment of AVC varies the rate at which volume is increased or decreased relative to vehicle speed.

Touch and hold the plus or minus symbol to adjust the volume of the selected function.

Note: If any of the volume sliders are adjusted to the fully '-' position, then the volume is turned fully off.

Confirm your selection by touching 'OK'.



JOL.1308Z

BRIGHTNESS/CONTRAST

After touching the 'Brightness/Contrast' button, the screen displays the touch-controls for adjustment of the screen display characteristics. The centre window shows the currently selected navigation view.

Touch the plus or minus symbol to adjust the selected function.

Screen brightness and contrast can also be dimmed for night driving. This is achieved either manually via the 'Day', 'Night' or 'Twilight' touch-controls (independent of the exterior light switch position), or automatically via the 'Auto' touch-control (controlled by the exterior light switch position).

Touch the 'Default' button to restore the default settings.

Confirm your selection by touching 'OK'.

1-10 Owner information



JaguarNet Telematics system

The JaguarNet telematics system, where fitted, provides emergency/roadside assistance and access to information services. The system uses the vehicle's Jaguar in-car telephone installation to communicate with the Jaguar response centre.

JaguarNet can be used wherever a cellular phone service is available.

Caution: Do not press the SOS button on the overhead console or touch-screen unless you have an emergency and require the emergency services. If you require information or roadside assistance, press the 'i' button on the overhead console or the 'Info' button on the touch-screen.

Before using the system

Limitations of the system



WARNING:

It is important that the operation of the system is properly understood before attempting to use it. Note the following summary of limitations:

- The system is powered by the vehicle battery and will not operate if the battery is discharged or disconnected.
- The system will only operate in areas with cellular phone coverage and when connection to the network is established. This can be affected by adverse weather conditions, geographical features or tall buildings.
- Loss of contact with the Global Positioning Satellite (GPS) system could result in an inaccurate vehicle position being sent to the response centre.
- If the vehicle is involved in an accident, components could be damaged rendering the system inoperative.

Registration

The following registration procedure should be carried out as soon as possible after acquiring the vehicle. The following information will be required:

- Full name.
- Home address.
- Work and home telephone numbers.
- Date of birth.

Note: During the registration procedure the vehicle must be stationary and not located inside a building.

1. Turn on the ignition (position 'I').
2. Push and hold the 'i' button on the overhead console for two seconds. A call is made to the response centre. (During the call the touch-screen or radio displays a sequence of messages and the red lamp in the 'i' button will flash.)
3. Tell the response centre operator that you wish to register, and give the above information when requested.
4. Do not end the call. The call will be terminated by the operator when all the questions have been answered.

The system will be fully operational within approximately one hour of making the call.

Emergency assistance (SOS)

The emergency assistance feature allows access to the emergency services (police, fire, or ambulance). Once assistance has been requested, and the vehicle location confirmed, the appropriate services are contacted for assistance to be despatched.

The benefits of the system are:

- Ease of activation.
- No requirement of knowing who to call.
- Emergency assistance call sent automatically in the event of airbag deployment.
- Vehicle location identification based on GPS data sent to the operator.

Emergency assistance can be used in the following situations:

- If you have been involved in an accident.
- Airbag deployment (emergency assistance call sent automatically).
- When urgent medical attention is required.

The GPS system is used to identify the position and direction of travel of the vehicle.

Emergency help will be despatched to your location and the operator will, when appropriate, stay in direct contact with you until the emergency help arrives.

Information assistance (Info)

The information and roadside assistance feature may be used to request help, breakdown assistance or information from the response centre operator.

The assistance given will depend upon the facilities available to the response centre operator, which may include information regarding local hotels, local petrol stations, shops and services, and traffic information.

Data message

When contact with the response centre is established, an electronic data message is automatically transmitted to the response centre computer. This data message will include:

- Type of activation (information, emergency or airbag deployment).
- System identification number.
- Latitude and longitude coordinates.
- Vehicle position history.
- Time tag identifying when last position was taken.



Operation of the system

Note: The ignition must be turned on (position 'I').

The system is operated from the controls on the touch-screen or the overhead console buttons. While in use, the touch-screen or radio displays a sequence of messages, and the red lamps in the overhead console buttons will flash to indicate activation.

Note: The phone handset will be switched off during an assistance call.

1-12 Owner information

Call activation and termination

Operation will continue even if the ignition is turned off following an activation.

Note: Once a call has been initiated, do not attempt to crank the engine as this may cancel the activation.

Making an emergency call (SOS)

The procedure for obtaining emergency assistance is as follows:

- Press and hold the SOS button in the overhead console for 2 seconds, or;
- Touch and hold the SOS button on the touch-screen for 2 seconds (displayed by pressing the 'MENU' button and touching 'JaguarNet').

A call is made to the response centre.

The touch-screen or radio shows 'SOS REQUEST' and the red lamp in the SOS button starts to flash.

Operator contact: After the data message transmission has been completed, voice contact with an operator is established. The operator will have available the details of the vehicle, including its last location.

Terminating an emergency call: When the operator is satisfied that the situation has been dealt with, the call will be terminated and the red lamp in the SOS button will extinguish. Normally, only the response centre can terminate an SOS call.

Making an information call (Info)

- Press and hold the 'i' button in the overhead console for 2 seconds, or;
- Touch and hold the 'Info' button on the touch-screen for 2 seconds (displayed by pressing the 'MENU' button and touching 'JaguarNet').

A call is made to the response centre. The touch-screen or radio shows 'INFO REQUEST' and the red lamp in the 'i' button starts to flash.

The operator verbally obtains details of the information request and the appropriate assistance will be provided.

Terminating an information call: An information call may be terminated via the Send/End button on the radio, the touch-screen End Call touch button, or by the response centre.

Further information

On-screen messages

During an assistance call, various status messages are displayed on the radio or touch-screen, which enable the progress of the call to be followed. A list of the messages and their meaning is shown on pages 1-14 and 1-15.

While in contact with the response centre, the vehicle location messages (LATITUDE and LONGITUDE), and system identification message are displayed in sequence, except when the display of another message is required.

System self-test

The system will perform a self-test each time the ignition is turned on (position 'I'). This is indicated by the illumination of the red lamp in the Information and SOS buttons. The lamp will remain illuminated for the duration of the test. If the lamp does not extinguish within 10 seconds, and stays on continuously, contact your Jaguar Dealer.

Cellular phone interface

If the phone is in use when the system is activated (for example an airbag deployment), that call will be terminated and a call to the response centre will be made.

When an activation is terminated, your phone is left unlocked if the ignition is still ON. If the ignition is in the OFF position the phone will be switched off after 5 minutes (see the In-car Telephone Handbook).

Battery disconnection

If the battery has been disconnected, the vehicle location will be lost. On reconnection, it may take up to approximately 15 minutes to re-establish accurate vehicle position.

1-14 Owner information

Message list

During operation, a sequence of messages will appear on the radio or touch-screen. These are described below.

Message	Meaning
SOS REQUEST	Emergency call initiated.
INFO REQUEST	Information/Roadside Assistance call initiated.
CALL IN PROGRESS	Call is being processed.
DIALLING	Response centre is being contacted.
SENDING DATA	Vehicle location data is being sent to the response centre.
DATA RECEIVED	Vehicle location data received by the response centre.
ID XXXXX XXXXX	System identification number.
LAT XXXX XXXX	Vehicle position – latitude.
LON XXXX XXXX	Vehicle position – longitude.
NETWORK BUSY	Trying to connect to response centre.

Message list (continued)

Message	Meaning
PLEASE WAIT	Waiting for reply from response centre.
NO SIGNAL	No network present.
ACQUIRING	Trying to obtain a network signal.
UNABLE TO CALL	Call failed.
JAGUARNET FAULT	System failed. See your Jaguar Dealer.
REDIALING	Redial sequence initiated.
PHONE REMOVED	Portable removed from cradle.
INSTALL PHONE	Install phone to continue call.
NON JAGUARNET PHONE	Portable does not function with the JaguarNet system.

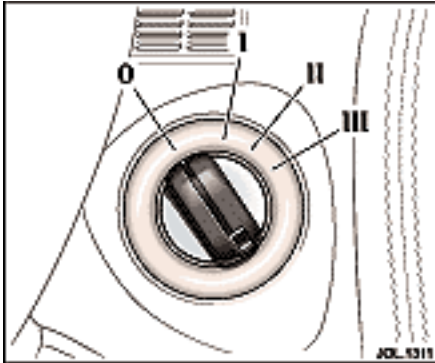

Ignition switch

The fascia-mounted ignition switch, on the right-hand side of the steering column, has four key positions:

0 ___ Ignition OFF.

I ___ Auxiliary.

II ___ Ignition ON.

III ___ Engine start.

When the key is turned back to the OFF position, the delayed accessory feature becomes active. The circuits available in the auxiliary position remain activated for a preset timed period.

Position '0': Is the only position in which the key can be inserted and removed. When the key is removed the steering lock is engaged.

Position 'I': Allows use of some electrical circuits, for example, radio operation. The airbag system is activated in this position.

Position 'II': All electrical circuits except the starter motor are activated. The key remains in this position when driving.

Position 'III': The starter motor is operated for as long as the key is held in this position, against spring pressure.

To remove the ignition key

Manual transmission vehicles only

Apply the parkbrake and turn the key to position '0'. The key can then be removed from the switch.

Automatic transmission vehicles only

Automatic transmission vehicles have a key interlock feature.

Apply the parkbrake, place the gear selector in 'P' and turn the key to position '0'.

The automatic transmission gear selector must be placed in Park 'P' before the key can be removed from the ignition switch. When the key is removed, the gear selector will be locked in Park.

Gear-shift interlock: A brake pedal/gear-shift interlock system is incorporated in the automatic transmission gear selector mechanism.

To move the gear selector from Park:

1. Turn the ignition key to position 'II' or start the engine.
2. Press the brake pedal.

2-2 Security and locks

Vehicle security

When leaving the vehicle unoccupied, remember the following:

- Apply the parkbrake and, with automatic transmission, move the gear selector to Park 'P'.
- Do not leave children or pets in the vehicle unattended.
- Do not leave luggage or valuables on view. Always take your valuables with you or lock them in the luggage compartment.
- Remove the ignition key and spare keys, even when the vehicle is in your garage.
- Close all windows and lock all doors securely.
- Park the vehicle where it can be seen. At night, park in a well-lit area.
- Ensure that all key transmitters are removed from the vehicle before locking the doors, and that all doors, the luggage compartment and the hood are closed.

It is important to keep your keys in safe places at all times. Leaving them in conspicuous places is an invitation for a thief to steal them and, consequently, your vehicle or belongings. Keep them as secure as you would your wallet or purse, both at home and away.

Immobilisation system

This vehicle is equipped with an immobilisation system which prevents it from being driven away by an unauthorised person.

An electronic device is fitted in the head of each key which is programmed to the vehicle electronics. When the key is placed in the ignition switch, a sophisticated decoding process is used to validate the key transponder code. The engine cannot be started unless the key is programmed to the vehicle electronic systems.

When turning the key in the ignition switch to start the engine, if the security status light on the centre console remains flashing a fault condition is indicated, and it is possible that the engine will not start. Please contact a Jaguar Dealer to investigate the cause of the light flashing even if the engine starts.

Keys

Vehicles are supplied with two key transmitters, which comprise the key body integrated with the remote transmitter, and one green-headed key. Separate keys, black- or green-headed, without the transmitter, are also available from Jaguar Dealers.

The key number is recorded on an adhesive label which is fixed to the back of each key. Peel off the label and keep safely, not in the vehicle.

Each black-headed key will operate the ignition switch and lock the doors, luggage compartment and the glove compartment.

The green-headed key is a valet key which will not unlock a locked glove compartment or locked luggage compartment lid when the valet switch has been set.

A maximum of eight keys can be used, of which up to four may be key transmitters. All the keys and transmitters used must be programmed to the vehicle by a Jaguar Dealer.

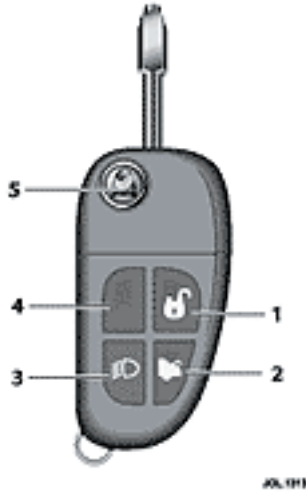

Key transmitter

The security system can be controlled remotely by a radio frequency, battery-operated, integrated key transmitter.

The transmitter is activated by pressing one of the operating buttons.

1. Unlocks and disarms the vehicle. Pressing and holding the button will globally open the vehicle windows (and sunroof, if fitted).
2. Releases the luggage compartment lock.
3. Activates the convenience headlamp feature and sounds the panic alarm (where fitted).
4. Locks and arms the vehicle.
5. Locks/unlocks the key. To free the key, press the release button (5). When not required press and hold the button and fold the key into the transmitter housing.

Note: Key transmitters will not operate if a key is in the ignition switch.

Each integrated key will operate the ignition switch, and lock the doors and glove compartment.

Caution: Should a key transmitter be lost, a new one can be obtained and programmed to the vehicle by a Jaguar Dealer, who will ask for proof of vehicle ownership. It is advisable to notify a Dealer as soon as a key transmitter is lost or stolen and have the remaining key transmitter(s) reprogrammed. This will then prevent the lost or stolen key transmitter from being used to disarm and unlock the vehicle.

Note: Dealers keep a log of all enquiries for replacement keys and notify Jaguar Cars Ltd. of any such requests.

Care of key transmitters

The key transmitters must be treated with care and not exposed to extremes of heat, dust, humidity or be in contact with fluids. Do not leave the transmitter exposed to direct sunlight.

The battery is the only serviceable part.

Radio frequency approval

Where radio frequency approval is required, the necessary information is shown on page 2-16.

2-4 Security and locks



Key transmitter battery renewal

When the battery needs renewal there will be a significant decrease in the effective range of the key transmitter. To renew the battery, follow the procedure below.

- Insert a small, flat-blade, screwdriver at an angle of about 45 degrees, into the slot on the back of the key transmitter as shown (A). Apply light pressure to the screwdriver and lever the screwdriver forward to separate the two halves of the key transmitter. Finally, pull the transmitter from the key body.
- Insert the screwdriver into the slot between the transmitter covers, located at the front of the transmitter, as shown (B). Apply light pressure to the screwdriver and lever the screwdriver downward to separate the covers.
- Unscrew and remove the small screw (C) and remove the printed circuit board, taking care not to touch the battery terminals. Remove the battery and dispose of it safely.
- Fit a new cell, type CR2032 (available from your Jaguar Dealer), with the side marked with the positive symbol (+) downwards in the battery receptacle. Avoid touching the new battery as moisture/oil from the fingers can reduce the life of the battery and corrode the contacts.
- Replace the printed circuit board making sure to engage the board under the securing tabs (D), and secure with the screw.
- Refit the cover and click into place with thumb pressure.
- Slide the transmitter back onto the key body until it clicks into place.

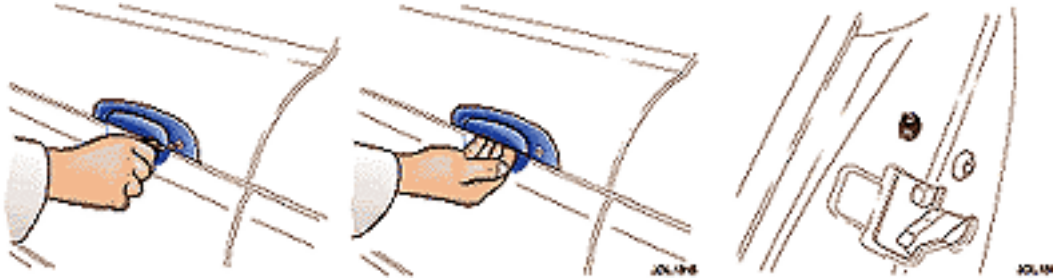

Door locks and handles

Only the driver's door has a key lock. All doors can be locked and unlocked either remotely using the key transmitter buttons, or by using the integrated key.

Smart locking

This feature helps prevent locking the key in the vehicle.

If the driver's door is open and an attempt is made to lock the doors using the driver's door interior locking lever, all doors will lock, and the driver's door only will then become unlocked.

If the front passenger door locking lever is used to lock the doors when the front passenger door is open, then all doors will become locked and then unlocked. (The vehicle can only be locked from the outside by using the key in the driver's door lock or remotely using the key transmitter.)

Child safety locks

Child safety locks are fitted to the rear doors. The operating lever is fitted above the door lock mechanism.

To operate: Open the door and move the lever a quarter turn. This immobilises the interior handle.

The door can then only be opened using the exterior door handle.

Open the door and move the lever to its original position to remove the child lock feature.

2-6 Security and locks

Vehicle locking and unlocking

To lock the vehicle and set alarm

- Press the lock button on the key transmitter, or,
- Put the key in the driver's door lock, turn the key towards the rear of the vehicle and release.

The direction indicators will flash once, the security light on the top of the fascia will start flashing and, after 20 seconds, the alarm will be set.

If a door, the hood or the luggage compartment lid are open and an attempt is made to lock the vehicle with the key in the driver's door lock, the direction indicators will flash five times as a warning that the vehicle is not secure.

If a door is open and an attempt is made to lock the vehicle with the transmitter, the direction indicators will flash seven times as a warning that the vehicle is not secure.

If the hood or luggage compartment lid are open and an attempt is made to lock the vehicle with the transmitter, the direction indicators will flash five times as a warning that the vehicle is not secure.

To unlock the vehicle and disarm the alarm system

Using a key transmitter

- Press the unlock button on the key transmitter.

Single stage unlocking – This unlocks all doors and the luggage compartment and turns on the interior lights.

Two stage unlocking – This only unlocks the driver's door and luggage compartment and turns on the interior lights. A second press is required to unlock all doors.

The direction indicators will flash twice as unlocking takes place.

Using a key

- Put the key in the driver's door lock, turn the key towards the front of the vehicle and release.

Single stage unlocking – This unlocks all doors and the luggage compartment and turns on the interior lights.

Two stage unlocking – This only unlocks the driver's door and luggage compartment and turns on the interior lights. A second turn of the key is required to unlock the remaining doors.

Selecting single/two stage unlocking

The procedure for changing from single stage to two stage unlocking, or vice versa, is as follows.

- Press and hold the lock and unlock buttons on the key transmitter simultaneously for four seconds.

Note: A single flash of the external direction indicators will confirm the required selection.

Global open/close

Global closing



WARNING:

Ensure that all occupants are kept clear of the windows and sunroof aperture.

Key in the driver's door: Turn and hold in the lock position to close all the electrically operated windows (and sunroof, if fitted).

Global opening

Key in the driver's door: Turn and hold in the unlock position to open all the electrically operated windows (and sunroof, if fitted).

Key transmitter: Press and hold the unlock button for longer than 2 seconds to unlock the vehicle and to open all the windows (and sunroof, if fitted). Pressing the button again while global opening is taking place will stop all movement.

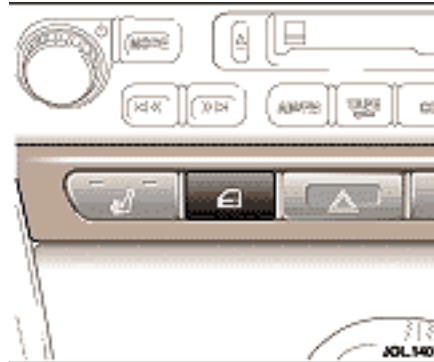

Centre console switch

Press and hold the central locking button on the centre console to globally lock or unlock all doors, and to globally close or open all the windows (and sunroof, if fitted).

Note: The central locking button only operates with the ignition switch in position 'I' or 'II', or while the delayed accessory feature is active.

2-8 Security and locks

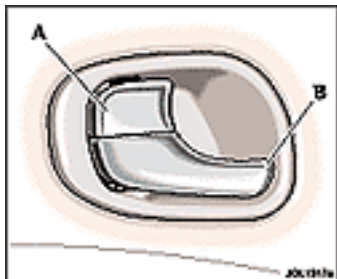

Internal door locking and unlocking

Each internal door handle comprises a lock lever (A) and release handle (B).

To centrally lock all doors, press the lock lever on the driver's or front passenger's door.

To lock a rear door, press the lock lever.

To unlock a front door, pull the release handle or the lock lever.

To unlock a rear door, pull the release handle or the lock lever.

The driver's or front passenger's door lock lever will unlock all doors.

For operation of the central locking button, see **Centre console switch** on page 2-7.

Drive-away door locking

This feature is an additional occupant safeguard which locks all the doors and the luggage compartment after a journey has been started.

For the feature to operate, the ignition switch must be in position 'II', the parkbrake released and the vehicle moving forward at a speed above 3 mph (5 km/h).

Note: For vehicles with automatic transmission, the gear selector lever must be moved out of the 'P' or 'N' position.

The doors will remain locked, even when the vehicle is stopped unless the driver or front passenger unlocks a door.

If a door is opened during a journey, the doors will automatically lock again when the vehicle starts to move.

All vehicles have the drive-away door locking feature installed during manufacture. This feature can be disabled, or reinstated, by a Jaguar Dealer, if required.

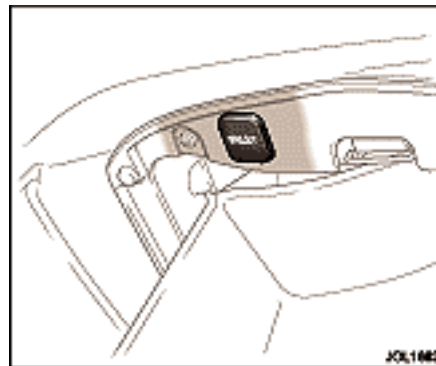

Valet switch

Before handing the green-headed valet key to the parking attendant, open the glove compartment, press the valet switch and then close and lock the glove compartment with an integrated key or a black-headed key. The attendant can then lock the car after parking, but cannot open the glove compartment or the luggage compartment.

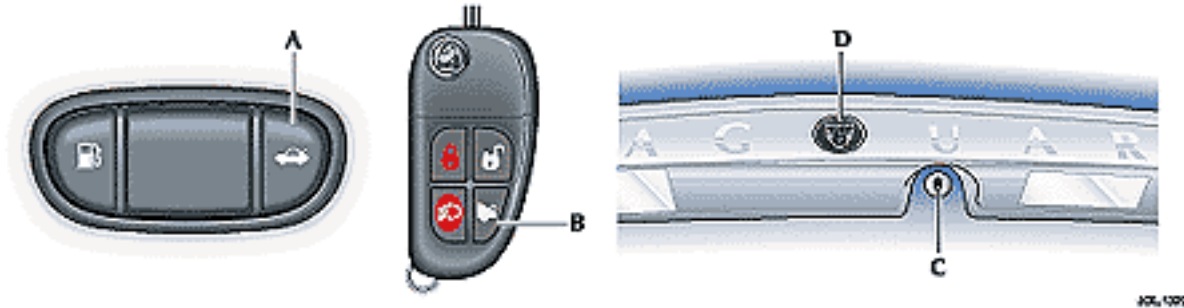

Luggage compartment

To open the luggage compartment:

- Press the luggage compartment lid release switch (A) on the fascia switchpack, or,
- Press the luggage compartment button (B) on the key transmitter, or,
- With the vehicle unlocked, press the release button (D) on the compartment lid.

Note: An integrated key or a black-headed key can be used to open the luggage compartment lid release lock (C), (turn clockwise to release), but opening with the key when the vehicle is armed will cause the alarm to sound.

Use a transmitter, or place the key in the ignition, to turn the alarm off if it sounds as a result of opening with a key.

If the vehicle alarm system is armed and the luggage compartment is opened using the key transmitter, the alarm will not sound. The system will be rearmed when the lid is closed, provided the vehicle has not been disarmed.

Neither the luggage compartment lid release switch on the fascia switchpack nor the lid release button will operate when the vehicle is armed.

2-10 Security and locks



Luggage compartment emergency release

Your vehicle is equipped with a mechanical interior luggage compartment release handle that provides a means of escape for children and adults in the event they become locked inside the luggage compartment.

Adults are advised to familiarise themselves with the operation and location of the release handle.

To open the luggage compartment lid from the inside, pull the illuminated 'T'-shaped handle and push up the lid. The material that the handle is made of will glow for hours in the darkness of the luggage compartment following brief exposure to ambient light.

The 'T'-shaped handle is located on the luggage compartment lid.



WARNING:

1. **Keep vehicle doors and the luggage compartment locked and keep keys out of a child's reach. Unsupervised children could lock themselves in an open compartment and risk injury. Children should be taught not to play in vehicles.**
2. **On hot days, the temperature in the luggage compartment and vehicle interior can rise very quickly. Exposure of people or animals to these high temperatures for even a short time can cause death or serious heat-related injuries, including brain damage. Small children are particularly at risk.**

Alarms and audible signals

Note: In certain markets, legislation prohibits the use of audible confirmation signals. In such cases, the sound source has been removed from the system.

Audible signals

Two horn chirps will sound if an attempt is made to lock the vehicle if a door is not fully closed. There will be no audible signal if the vehicle is locked when the hood or luggage compartment is not fully closed.

Error signal

The direction indicators will flash five times whenever the key is out of the ignition and one of the following conditions is present:

- If any door is open when an attempt is made to lock the vehicle by inserting a key in the driver's door lock.
- The luggage compartment or the hood is not properly closed when an attempt is made to lock the vehicle either by inserting a key in the driver's door lock or by using the key transmitter.

The direction indicators will flash seven times whenever the key is out of the ignition and one of the following conditions is present.

- If any door is open when an attempt is made to 'arm' the security system using the key transmitter.
- If either of the front doors is open when an attempt is made to lock the vehicle using the lock levers on the front two doors.

Full alarm

Once armed, any of the following circumstances will create a full alarm state, sound the horns and flash the direction indicators:

- Opening a door, luggage compartment lid (except with transmitter) or hood.
- Using a key in the ignition switch which is not programmed to the vehicle.
- Any attempt is made to remove the radio.

2-12 Security and locks

Security features

The security system has been designed for:

- Prevention of theft of the vehicle.
- Prevention of theft of items from the vehicle.
- Personal security.

The security system is integrated with the vehicle electronics and engine management systems making it far more difficult for a thief to penetrate and steal the vehicle.

Battery reconnection

If the battery has been disconnected and is subsequently reconnected, the alarm system will re-arm as the battery is reconnected.

Note: Ensure that a key transmitter is available to disarm the system when reconnecting the battery. Either press the unlock button on the transmitter, or insert the key in the ignition switch.

Panic alarm

When in or near the vehicle, the panic alarm (where fitted) can be set off to deter a possible offender. For this feature to operate, the key must not be in the ignition switch.

Pressing the headlamp convenience/panic button on the key transmitter three times within three seconds will activate the 'Panic Alarm'.

The alarm is stopped by inserting the key in the ignition switch and turning to position 'I'.

Radio frequency

The radio frequency remote system operates on a frequency subject to USA Federal Communications Commission (FCC) rules.

The device complies with Part 15 of the FCC rules and RSS-210 of the Industry Canada. Operation is subject to the two following conditions:

1. The device may not cause harmful interference.
2. This device must accept any interference received, including interference that may cause undesired operation.

The key transmitter radio frequency approval numbers for the USA and Canada are as shown below.

USA – NHVWB1U241

Canada – 3495 103 2304.

Note: The manufacturer is not responsible for any radio interference or TV interference caused by unauthorised modifications to this equipment. Changes or modifications not expressly approved by the party responsible for compliance could void the user's authority to operate the equipment.

Caution: The key-transmitter may suffer interference from other legal users of this radio frequency band, such as radio amateurs, medical equipment, remote controls or alarm systems. To lock or unlock the vehicle in such a situation, either use a key or operate the key transmitter as close to the security antenna as possible.



HomeLink® Universal Transceiver

The HomeLink® Universal Transceiver, (where fitted), is located in the roof console. The transceiver can be programmed to transmit the radio frequencies of up to three different transmitters used to activate garage doors, gates, home lighting, security systems, or other radio frequency operated devices.

For further information, or for assistance, contact your Jaguar Dealer, or the supplier by phone or via the internet. For details, see **Information and assistance** on page 2-14.



WARNING:

1. **Do not use the transceiver with any garage door opener that lacks the safety stop and reverse feature as required by federal safety standards. A garage door opener which cannot detect an object, signalling the door to stop and reverse, does not meet current federal safety standards. Using a garage door opener without these features increases risk of serious injury or death.**
2. **When programming the transceiver to a garage door opener or entry gate, make sure that people, the vehicle and objects are out of the way to prevent potential harm or damage as the gate or garage door will activate during the programme.**

Programming

Note: For best results, fit a new battery to the hand-held transmitter of the garage door opener (or other device) before programming. If your garage door opener receiver (located in the garage) is equipped with an antenna, ensure that the antenna is hanging straight down.

1. Switch off the engine.
2. Press and hold the two outermost buttons (1 and 3) on the transceiver, releasing only when the indicator light begins to flash after 20 seconds.

Note: Do not repeat step 2 when programming the additional buttons.

3. Hold the end of the hand-held transmitter approximately 1 to 3 inches (25 to 75 mm) away from the transceiver in the roof console, keeping the indicator light in view.
4. Using both hands, simultaneously push the hand-held transmitter button and the chosen transceiver button (1, 2 or 3). The transceiver indicator light will flash, first slowly and then rapidly. When the indicator light flashes rapidly, release both buttons. The rapid flashing light indicates successful programming of the frequency signal.

2-14 Security and locks

5. Press and hold the programmed transceiver button to activate the programmed device and release when the device begins to activate.
6. If, after 90 seconds, the indicator light does not flash rapidly, release both the transceiver and the hand-held transmitter buttons and repeat the procedure starting with Step 2. However, position the hand-held transmitter at a different angle and/or distance.
7. The device must now be 'trained' for operation from the transceiver. See **Training procedure** on page 2-15.

Programming hints and tips

If the device does not operate you may need to complete the steps outlined in the section **Rolling code programming**.

Some entry gates and garage door openers may require you to replace Step 4 with the procedures in the section **Canadian programming/ Gate programming**.

If you are programming a rolling code equipped device, continue with the procedures outlined in the section **Rolling code programming**.

Note: Keep the original transmitter for future use or programming procedures if, for example, you purchase a new vehicle.

Caution: It is recommended that **when you sell or dispose of the vehicle, the programmed transceiver buttons be erased for security purposes.**

Canadian programming/ Gate programming

Canadian frequency laws, and the technology of some entry gates, require you to press and re-press (cycle) the hand-held transmitter button every two seconds during programming.

Continue to press and hold the desired transceiver button while you cycle your hand-held transmitter until the indicator light flashes rapidly.

Note: When programming a garage door opener or entry gate, unplug the device during the 'cycling' process to prevent possible motor failure.

Rolling code programming

Rolling code garage door openers (or other rolling code devices) which are 'code protected' may be determined by the following:

- Reference the device owner's instruction manual for verification.
- The hand-held transmitter appears to programme the transceiver correctly, but does not activate the garage door.
- Press and hold the programmed transceiver button. The device has the rolling code feature if the transceiver indicator light flashes rapidly and then turns solid after two seconds.

To programme a garage door opener or other device with the rolling code feature, follow these steps after completing the section **Programming**.

Information and assistance

If you would like additional information on the HomeLink® Universal Transceiver, compatible products or to purchase other accessories such as the HomeLink® lighting package, contact your Jaguar Dealer, or HomeLink at 1-800-355-3515 or on the Internet at www.homelink.jci.com.

Training procedure

Note: The aid of a second person may make the following training procedure quicker and easier.

1. Locate the training button on the garage door opener receiver (or other device). Exact location and colour of the button may vary. If there is difficulty locating this button, refer to the instruction manual supplied with the device.

Note: Following step 2 there are 30 seconds in which to initiate step 3.

2. Firmly press and release the training button on the receiver which will activate the training light.
3. Firmly press and release the transceiver button. Press and release the transceiver button a second time to complete the training process. Some devices may require you to do this step a third time to complete the training.

The device should now recognise the transceiver signal and activate when the transceiver button is pressed.

The remaining buttons may now be programmed if this has not been previously done.

Reprogramming a transceiver button

To programme a device using a button that has previously trained, follow these steps:

1. Press and hold the desired transceiver button. Do not release until step 4 has been completed.
2. When the indicator light begins to flash slowly (after 20 seconds), position the hand-held transmitter 1 to 3 inches (25 to 75 mm) away from the transceiver surface.
3. Press and hold the hand-held transmitter button.
4. The transceiver indicator light will flash, first slowly and then rapidly. When the indicator light begins to flash rapidly, release both buttons.

The previous device has now been erased and the new device can be activated by pushing the transceiver button that has just been programmed. This procedure will not affect any other programmed transceiver buttons.

Erasing programmed transceiver buttons

Individual buttons cannot be erased, however, to erase all three programmed buttons:

1. Press and hold the two outermost buttons until the indicator light begins to flash after 20 seconds.
2. Release both buttons.

The transceiver is now in the train, or learning, mode and can be programmed at any time following steps 3 and 4 in the section **Programming**.



WARNING:

The manufacturer is not responsible for any radio or TV interference caused by unauthorised modifications to this equipment. Such modifications could void the user's authority to operate the equipment.

2-16 Security and locks

Approvals for radio transceiver

Country	Approval No.
USA	CB2JAGHL3

Occupant protection

Seat belts

The use of front and rear seat belts is mandatory in most countries. Using seat belts saves lives. They should be worn by all occupants whenever the vehicle is in use, for maximum protection.

Lap/shoulder inertia reel seat belts are provided for both front occupants and three rear seat positions.

The inertia operating mechanism of the seat belts allows the wearers to move their upper bodies to reach various controls. The seat belts lock automatically with accelerated body movement or in the event of emergency braking.

The seat belt assemblies incorporate additional safety devices. All have belt pretensioners and the front belts also have force limiters. These devices provide increased protection in the event of a severe frontal impact.

The pretensioners operate in conjunction with the airbags as part of the Advanced Restraints Technology System (see page 3-3).

All passenger seat belt mechanisms incorporate an automatic locking device to allow child seats to be secured safely. See **Child safety** on page 3-12.



Seat belt fitting



WARNING:
Do not adjust the seat belt while driving.

Draw the tongue of the seat belt over the shoulder, across the chest and push it into the buckle unit slot. A positive 'click' indicates that it is safely locked.

The use of comfort clips or devices that would create slackness in the seat belt system are not recommended.

Ensure that the webbing is midway between the neck and the edge of the shoulder. Correct tension is controlled by automatic retraction of the reel.

When the ignition is switched to position 'II', a chime sounds for six seconds and a warning light is illuminated on the instrument panel for 60 seconds if the driver's seat belt remains unfastened.

Note: If the vehicle is parked on unlevel ground, the seat belt mechanism may lock. This is not a fault, gently ease the belt from its attachment to unlock it.

3-2 Before driving

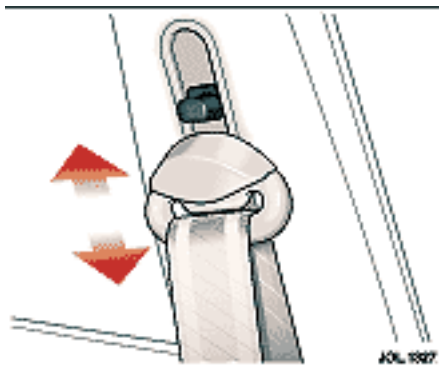

Front belt height adjustment

To adjust the front seat belt heights, press the locking button and slide the anchorage so that the seat belt webbing passes over the shoulder without pulling against the neck. Release the button and check that the anchorage point is locked.

Always check the anchorage point after the seat has been adjusted to ensure that the belt is correctly positioned.

Inertia reel mechanism check

Static test: Whilst seated, fasten the seat belt and grip the shoulder belt at approximately shoulder level with the opposite hand. Pull the belt sharply downwards, the belt should lock.

Road test: The following road test must be carried out only under maximum safe road conditions.

With the seat belt correctly fitted to the driver and passenger(s), drive the vehicle at 5 mph (8 km/h) and, ensuring that it is safe to do so, brake sharply.

The seat belt(s) should lock automatically, holding both driver and passenger(s) securely in position.

It is important when braking that the reactions of both driver and passenger(s) are normal, that is, the body must not be thrown forward in anticipation, thus causing a snatching action of the belt which would operate the locking mechanism.

If the belt fails to lock on either test, consult a Jaguar Dealer.



WARNING:

1. **Seat belts are designed to bear upon the bony structure of the body. The lap section of the belt must be worn low across the front of the pelvis and NOT across the abdominal area. Always ensure that the webbing is midway between the neck and the edge of the shoulder.**

2. **Care should be taken to avoid contamination of the webbing with polishes, oils and chemicals, and particularly battery acid. Cleaning may safely be carried out using mild soap and water. If webbing becomes frayed, contaminated or damaged, discard it and fit a new seat belt.**
3. **It is essential to renew the entire assembly after it has been worn in a severe impact even if damage to the assembly is not obvious.**
4. **Belts should not be worn with the webbing twisted.**
5. **Each seat belt assembly must only be used by one occupant; it is dangerous to put a seat belt around a child being carried on the occupant's lap.**
6. **No modifications or additions should be made by the user which will prevent the seat belt adjusting devices from operating.**
7. **Should the seat belt not retract and remain at its static length, consult your nearest Jaguar Dealer immediately.**

Airbags

In order to provide optimum protection this vehicle is equipped with front and side airbags. They are used in conjunction with the seat belts to help protect occupants from upper body (thorax) and head injuries.

- The driver front airbag is located in the centre of the steering wheel.
- The front passenger airbag is located in the fascia panel immediately in front of the passenger seat.
- Thorax side airbags are fitted within the outboard bolsters of both front seats, and are identified by labels.
- A curtain airbag is fitted on each side, above the front and rear doors.

An alert label on the front face of the driver's and passenger's sun visor directs you to read the warning label on the rear face of each sun visor.

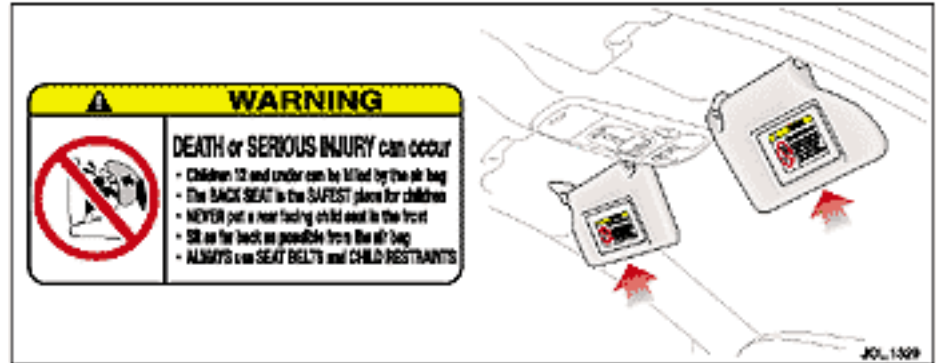

The warning label contains the following statement:



WARNING:

DEATH or SERIOUS INJURY can occur.

- **Children 12 and under can be killed by the airbag.**
- **The BACK SEAT is the SAFEST place for children.**
- **NEVER put a rear facing child seat in the front.**
- **Sit as far back as possible from the airbag.**
- **ALWAYS use SEAT BELTS and CHILD RESTRAINTS.**

Advanced restraint technology system

The airbags and seat belt pretensioners are electrically controlled by an advanced restraints technology system.

Various sensors determine the direction and severity of an impact and the presence and position of front seat occupants. The system analyses this information then deploys the appropriate airbags only e.g. the side airbags where the impact is on that side only.

Airbags are not deployed in a rear impact.

3-4 Before driving

Airbag deployment

To do their life-saving job, airbags must inflate rapidly and with considerable force. There is therefore a risk of death or serious injuries such as fractures, facial and eye injuries or internal injuries, particularly to occupants who are not properly restrained by seats belt or sitting correctly when the airbag deploys.

The risk of injury from a deploying airbag is greatest close to the trim covering the airbag.

The whole sequence of events from sensing the impact to full inflation of the bag takes place in a fraction of a second.

The noise and gas associated with the deployment of the airbags is not injurious to health.

After airbag deployment, it is normal to notice a smoke-like, powdery residue or smell the burnt propellant. This may consist of cornstarch, talcum powder or sodium compounds that result from the combustion process that inflates the airbag.

Small amounts of other chemicals may be present which may irritate the skin and eyes, but none of the residue is toxic.

While the system is designed to help reduce serious injuries, it may also cause minor burns, abrasions, swelling or temporary hearing loss.



WARNING:

- 1. No objects whatsoever should be attached to the centre cover of the steering wheel, the passenger fascia panel, the sides of the front seats or the interior trim immediately above the door openings. Do not put anything on or over the airbag inflation area. Placing objects on or over the airbag inflation area may cause those objects to be propelled by the airbag into your face and torso causing serious injury.**
- 2. Safety experts recommend a minimum distance of at least 10 inches (254 mm) between an occupant's chest and a front airbag.**
- 3. Children 12 years old and younger can be killed or seriously injured by the airbag. The rear seat is the safest place for children.**
- 4. Do not try to put an adult seat belt around two children.**
- 5. Several airbag system components get hot after inflation. Do not touch them after they have deployed.**
- 6. If an airbag is inflated, the airbag will not function again and must be renewed immediately. If a new airbag is not fitted, the unrepaired area will increase the risk of injury in a collision.**

Airbag fault warning light

The airbag warning light in the driver's instrument cluster will be lit for approximately six seconds when the ignition is turned on.

If the light remains on or flashes, it indicates a fault within the airbag electrical circuits. Report the fault to a Jaguar Dealer immediately. It is safe to drive the vehicle; however, in an accident the airbags may not operate.

Airbag warning light information is shown in Section 4.

Airbag disposal



WARNING:

Do not attempt to service, repair or modify the airbag system or its fuses. All work on the airbag system, including renewal after deployment and renewal at the end of its service life, must be carried out by an authorised Jaguar Dealer.

In the event of the vehicle being dismantled, airbag module removal and disposal **MUST** be made by a qualified person. Instructions can be obtained from an authorised Jaguar Dealer.

3-6 Before driving

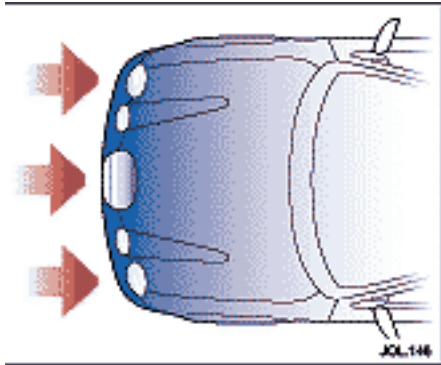

Front protection

With a front impact of sufficient force, the restraints system will trigger the front airbag(s) and seat belt pretensioners, which immediately tighten the seat belts.

For front occupants, the seat belt then slackens with increasing chest load, allowing the head and chest to more gradually come into contact with the inflated airbag. The airbag absorbs the remaining energy of the impact and then deflates rapidly via vent holes.

Front airbags are designed to inflate in frontal and near frontal collisions, not low speed impacts, roll-over, side-impact or rear-impact.

Where the airbags are not deployed, protection is provided by the seat belts.

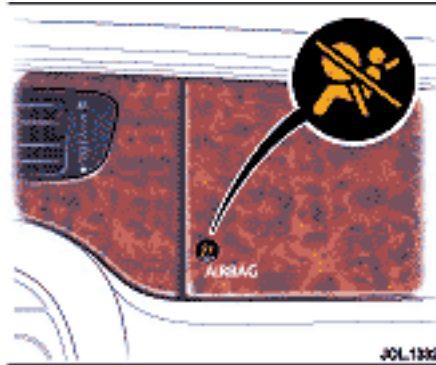

Occupancy sensing

Both front airbags use a dual inflation technology which means that, if activated, the bag(s) will deploy at either a normal or reduced level of inflation, depending on crash severity. The lower inflation level is also selected if the restraint system senses that the driver is close to the steering wheel.

The front passenger seat is monitored by ultra-sonic sensors (see illustration opposite) and a seat weight sensor to determine the presence, weight and position of the front passenger. In certain conditions, e.g. where no passenger is present, the appropriate airbags will be de-activated. In a collision these airbags would not be deployed.

Airbag de-activation warning light

The AIRBAG warning light on the passenger fascia is associated with the deployment conditions for front seat passenger airbags only.

- If the seat is empty, the front airbag will not be activated and the light will not be lit.
- If the seat is occupied by, for example, a small child, the front airbag will not be activated and the AIRBAG warning light will be illuminated.
- If the seat is occupied by a larger child or adult, the front airbag will be activated and the warning light will not be illuminated.
- If the passenger adopts a posture (e.g. leaning very far forward) which could cause injury from an inflating airbag, the front passenger airbag will not be activated and the AIRBAG warning light will be illuminated.

Note: Whenever the AIRBAG warning light on the passenger fascia is illuminated, the front passenger airbag will not be deployed in the event of an impact.

Note: The occupancy sensing system is designed to confirm that a front passenger is properly seated as recommended:

- Always sit centrally in the seat, remaining in contact with the seat back which for comfort should be rearwards of the vertical position.
- Adjust the seat to be as far back from the fascia as practical.
- Always wear seatbelts.

The seat adjustment controls are described on page 3-16.



WARNING:

It is important that the passenger position sensors (see illustration) are not obscured in any way which could affect airbag deployment, e.g. fitting non-approved accessories.

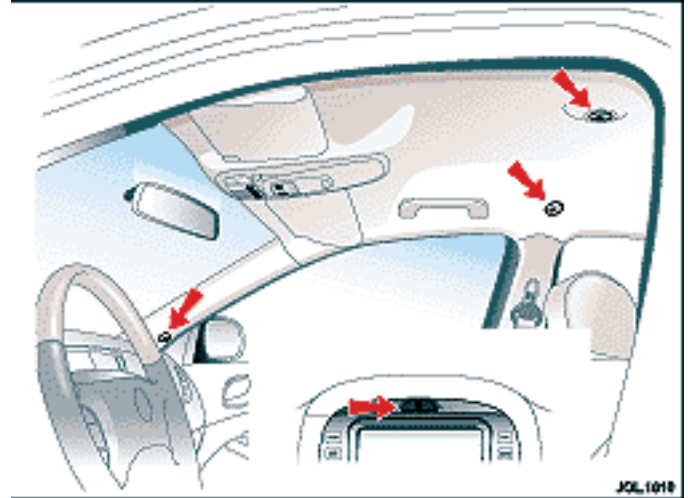

3-8 Before driving

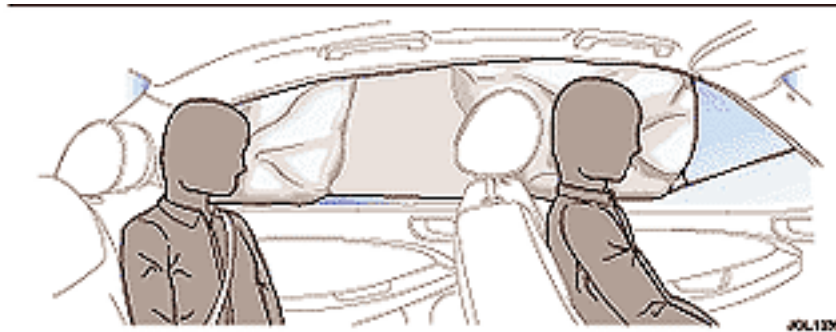
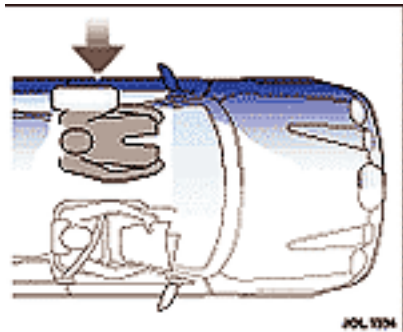

Side protection

The side protection system utilizes four airbags: Two mounted in the front seats, and two curtain airbags located just above the front and rear door openings under the headlining trim.

When the seat mounted thorax airbag inflates upon a vehicle side impact, it breaks through the seat bolster stitching, protecting the side of the rib cage of the driver or front seat passenger.

When the curtain airbag inflates upon a vehicle side impact, it breaks through the headlining and deploys downwards, giving head protection to the front and rear seat occupants on the impact side.

The curtain airbag on the front passenger side is always deployed in a side impact even if the front passenger seat airbags are de-activated. This is to maintain protection for a rear occupant.

Seat mounted thorax and curtain airbags are designed to inflate in a side impact collision, not rollover, rear-impact, frontal or near-frontal collisions, unless the collision causes sufficient lateral deceleration.

The airbags, in combination with the seat belts, can help reduce the risk of severe injuries in the event of a significant side impact collision.



WARNING:

To ensure that the side airbags are fully effective:

DO NOT sit too close to, or lean against the door trim. The side airbag could injure you as it deploys from the side of the seat.

DO NOT lean out of the window aperture.

Only use JAGUAR APPROVED accessories (e.g. seat covers).

Due to the function of the CURTAIN AIRBAG deployment, CONSULT your Jaguar Dealer prior to installing any ACCESSORIES in the upper environment/pillar trim area (e.g. HANDS-FREE TELEPHONE KITS).

Rear impact protection

Both front seats have active, energy absorbent backrests which, with correctly positioned headrests, reduce the risk of neck and spinal injury ('whiplash') in the event of a rear impact.

When activated, the seat backrests automatically move back and recline, altering the occupants' posture and reducing relative motion between the body and head.

The degree of backrest movement in a rear collision depends on the angle, speed and nature of the colliding vehicle.

After activation, the whiplash protection mechanism will not work again and the seat must be serviced by a Jaguar Dealer to restore the protective function.

Note: The amount of backrest movement depends on the severity of the impact and for a minor collision there may be no apparent change to the seat even where the protective system has been activated. After any rear collision, therefore, the seat must always be inspected by an authorised dealer.

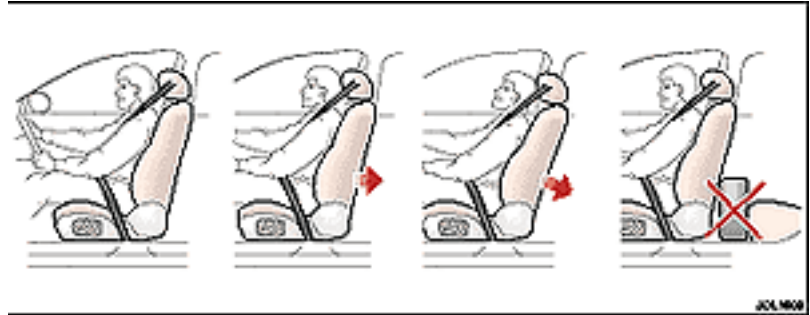

WARNING:

1. For optimum protection, the driver and passenger should sit in the centre of the seat with the head as close as possible to the head restraint.
2. Do not wedge objects (e.g. luggage) between the front seat backrest and the rear seat cushion.
3. After a rear collision, the front seats must be inspected by a Jaguar Dealer even where there is no apparent damage or change to the seat.
4. Do not attempt to service or tamper with the seat recliner mechanism.

3-10 Before driving

Wrong
Unbelted and too close

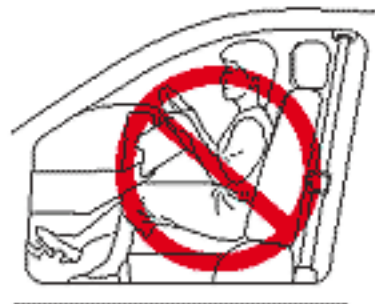

Use seat belts



If adjustable pedals fitted, move pedals towards seat



Move seat rearwards and recline seat back



Tilt wheel down/forwards



Correct
*Belted and 10 inches (254 mm)
or more away



Driving position



WARNING:

Driver and front seat passenger should always move their seats as far rearwards as is practical.

Ideally, drivers should sit with at least 10 inches (254 mm) between the centre of their breastbone and the cover of the steering wheel airbag.

Since the risk zone at the time of deployment is the first 2 to 3 inches (50 mm – 75 mm) from the airbag cover, sitting back 10 inches (254 mm) provides a clear margin of safety. Very few drivers are unable to achieve and maintain that safety gap.

The vast majority of drivers who do not now sit that far back can change their position and achieve that distance.

- If adjustable pedals are fitted, move them towards the seat.
- Move your seat back as far as you can while still comfortably reaching the pedals.
- Recline the back of your seat one or two notches from the upright position. If reclining the back of your seat makes it hard to see the road, raise the seat.
- Tilt the steering wheel/column downwards so as to point the airbag at your chest instead of your head and neck. Adjust the steering wheel/column fore/aft so that it extends towards the driver as little as possible, ensuring that the airbag has plenty of room to deploy.
- Sit in the centre of the seat with the head as close to the head restraint as possible.

Note: Seat, steering wheel and pedal adjustment controls are described elsewhere in this section.

3-12 Before driving



Child safety

JAGUAR CARS LTD. STRONGLY RECOMMEND THAT AT ALL TIMES CHILDREN SHOULD BE CARRIED IN THE REAR SEATS.

In many countries legislation governs how and where children should be carried when travelling in a vehicle. It is the responsibility of the driver to comply with all regulations in force in the country where the vehicle is being used.

Holding a baby or child in a person's arms is **not** a substitute for a child restraint system. Do not use a seat belt to restrain more than one person.

In an accident, a baby or child held in a person's arms can be crushed between the vehicle's interior and a restrained person.

The child can also be injured by hitting the interior or by being thrown from the vehicle during a sudden manoeuvre or impact.

Injury can also be caused if the baby or child is allowed to ride on the seat unrestrained. Other occupants should also be properly restrained to help reduce the chance of injuring the child.

Do not allow children to stand in the space between the front seats, or on the rear seats.

Children must be restrained by the use of a child safety restraint applicable to their weight and size. This vehicle is fitted with LATCH anchorage points and it is strongly recommended that an approved LATCH child seat is used.

If child seats other than the LATCH type are used, the seat must be secured using one of the rear inertia reel seat belts.

Where possible, always use the additional top anchorage.

Note: To ensure the maximum possible protection for your child, it is recommended that you use the safety restraints obtainable from your Jaguar Dealer, who will also advise on how to fit them.

Non-LATCH child restraints



WARNING:

DO NOT install a rearward-facing child seat in the front passenger seat position since deployment of the passenger fascia airbag could cause death or serious injury to the child. This is emphasised by the label displayed on the end of the fascia on the front passenger side, as shown on the illustration.

If however, you must sit a child in the front passenger seat, use only a forward facing child seat with the passenger seat set fully rearward. Always follow the fitting instructions supplied with the appropriate child restraint system.

Always ensure that child restraint assemblies are fitted in strict accordance with the child restraint manufacturer's instructions.

Look for the following when selecting a child restraint system.

- It should have a label certifying that it meets the applicable Regulations.
- Carefully read the instructions supplied with the restraint. Be sure you understand them and can install and use the device properly and safely in the vehicle.
- Ensure that the child restraint system is appropriate for the child's weight and development. The label required by the standard or regulations, or instructions for infant restraints, usually provide this information.

Wearing of child restraints

Ensure that there is no slack in the webbing and that the restraint fits the child snugly across the rib cage and hips. These are the parts of the body most able to take the force of impact.

The lap strap should pass across the top of the child's thighs, bearing on the pelvis, not the abdominal area.

Infant safety

Babies and small children who cannot sit up by themselves should be carried in an approved Jaguar baby seat.

Securing a child seat with adult belts

All passenger seat belts (not the driver's) have an automatic locking device for use with child seats.

If engaged, this device allows the belt to be retracted (tightened) but not pulled out. When used to secure a child seat, therefore, the belt will automatically lock at any point to which it has retracted.

- Fit the child seat in the correct position and secure with the seat belt in accordance with the manufacturer's instructions. If necessary, remove the headrest to accommodate a larger child seat.
- Pull the seat belt all the way out to engage the locking device.
- To fix the seat firmly, retract the belt back onto the reel; a ratchet operation may be felt as the belt retracts. Continue to pay the belt back onto the reel until it fits snugly around the child seat.

The above is a guide only. Depending on the features of a particular child seat, e.g. forward or rearward facing, engage the locking device before or after attaching the belt, as convenient.

Unbuckling the belt and releasing the child seat will allow the belt to resume its normal operation.

3-14 Before driving

LATCH child restraint system

LATCH (Lower Anchors and Tethers for Children) is an anchorage system which allows the child safety seat to be secured directly and easily to the vehicle body without the use of adult seat belts.

Many injuries to children in accidents are caused by the incorrect fitting and tensioning of the adult seat belts which are normally used to secure the child seat. The LATCH system reduces the likelihood of incorrect fitting and is also quicker and simpler to use.

The LATCH restraints system uses two anchorage loops fixed to the vehicle body for each rear outboard seat position. The child seat, which must be specifically designed for LATCH system fitting, is clipped into the loops via rigid extendable bars or a flexible tether strap. A quick release mechanism is usually incorporated to allow easy removal of the child seat.

The anchorage loops are accessible through the gap between the rear seat back and cushion. The gap is covered by a Velcro fastened flap.

Note: Forward facing child seats using the LATCH system must also be secured with a top tether (see subsection).

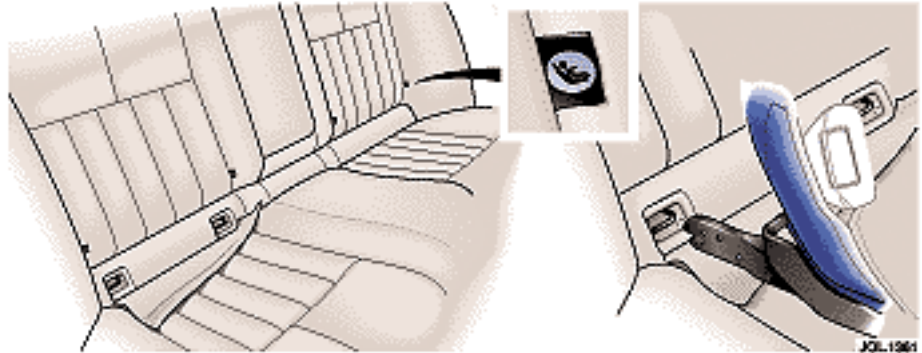

Fitting LATCH Seats

Consult your Jaguar Dealer to obtain a LATCH compatible seat.

Caution: When fitting a LATCH child seat, the seat manufacturers instructions must always be followed. The following is a guide only.

Note: So as not to interfere with the fitment of large child seats, push the adult seat buckles into their buckle recesses and, if necessary, remove the headrest.

LATCH seat with extendable bars – Fit the seat as follows:

1. Pull open the Velcro fastened flap between the seat back and cushion to expose the LATCH loops.
2. Fully extend the two attachment bars on the child seat (see manufacturer's instructions).
3. Locate the slots on the ends of the bars onto the two LATCH loops, then push the seat assembly rearwards until the bars are positively engaged (a trigger operates to lock the attachment bars onto the loops).
4. Slide the seat rearwards along the bars until it is locked firmly against the vehicle seat back. Confirm that it is securely locked in position.
5. Secure a forward facing child seat to the top tether anchorage.

LATCH seat with tether straps – Clip the flexible lower straps to the two LATCH loops. Adjust the length of each strap until the seat is held firmly against the vehicle seat back.



WARNING:

Do not install a LATCH child seat with flexible lower attachments in the vehicle centre seat position. The anchorage loops are only provided to install a compatible child seat in the vehicle outboard seat positions.

Child restraint top tether anchorages and brackets

The top of the child seat is connected by a short strap to a top tether bracket to prevent any tendency of the seat to rotate about the lower anchorages. The top tether brackets are positioned on the rear parcel shelf, under access covers, at the centre-line of each rear seating position.

Fit the top tethers in combination with the lower LATCH attachments or other child restraints to secure the seat.

Connect the top tether to the child seat (if it is not part of the seat) and pass it under the vehicle rear head restraint to connect to the fixed tether bracket on the parcel shelf. Adjust the length of the top tether strap to hold the top of the child seat against the vehicle seat back.



WARNING:

Child restraint anchorages are designed to withstand only those loads imposed by correctly fitted child restraints. Under no circumstances are they to be used for adult seat belts or for attaching other items or equipment to the vehicle.

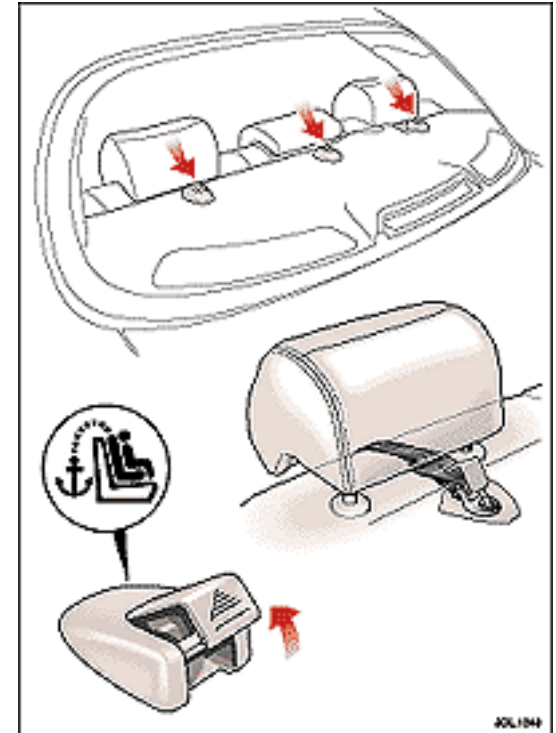

Seat adjustment



WARNING:

1. Do not make adjustments when the vehicle is moving.
2. Front passengers must not ride with the seat fully reclined.

Front seat adjustment

The front seats are adjusted electrically by switches on the side of the seat cushion. Adjustment can be made with or without the ignition key inserted.

The number of seat adjustments varies with the vehicle specification but all options are given here. If a seat movement is not specified for your vehicle, the control switch will either not be fitted or will not include that seat function (switch movement will be inhibited).

Seat adjustments for two people may be stored and recalled by the driver position memory system. See **Memory setting** on page 3-24.

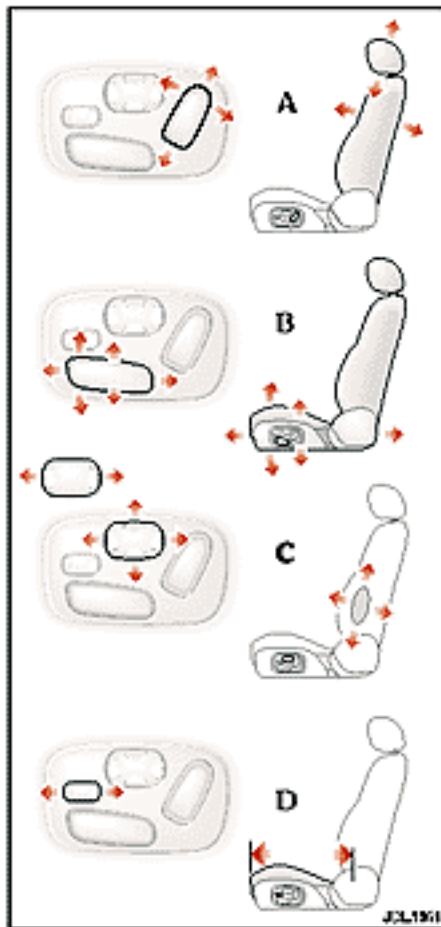

The full range of seat adjustments are:

A – Backrest angle (recline) and, if specified, headrest height.

B – Seat fore and aft position and, if specified, cushion height and front tilt:

- Move the switch forward or rearward to change the seat fore and aft position.
- Move the centre or rear of the switch up or down to adjust cushion height.
- Move the front of the switch up or down to tilt the front of the cushion.

C – If specified, provides adjustable lumbar support in the lower backrest. Either of two options may be fitted:

- **2-way or 4-way switch:** Press the front or back of the switch to increase/decrease lumbar support.
- **4-way switch only:** Press the top or bottom of the switch to adjust lumbar support upwards or downwards.

D – If specified, varies the cushion length. Moving the control will change the distance between the front of the cushion and the backrest.

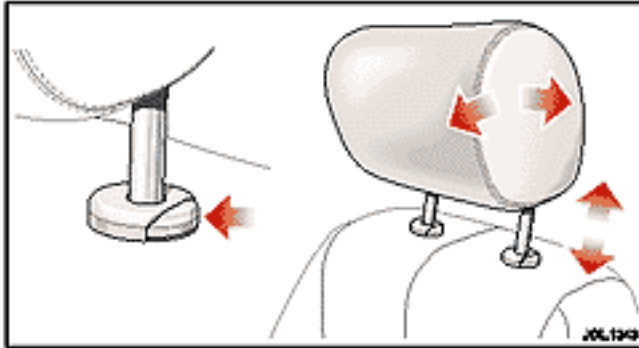

Manual head restraint adjustment



WARNING:

Adjust the head restraint so that it is just behind your head and never behind your neck.

Where electrically adjusted headrests are not fitted (see **Seat adjustment** on page 3-16), the front head restraints are manually adjustable:

- **To lower:** Press the button in the escutcheon and push the headrest into the seat back to the required height.
- **To raise:** Pull the headrest upwards.
- Swivel the head restraint forwards or backwards until it is comfortably positioned behind your head.

Rear head restraints – All rear head restraints are adjustable for height only.

Note: All headrests may be removed e.g. to fit a large child seat. Hold the escutcheon button down and pull out the headrest.



Front seat heaters

The optional heated front seats incorporate heaters in the backrests and cushions and have two heat settings. Each seat has a heater switch on the centre console. With the ignition switch in position 'II', press a switch to select the heat setting:

- A first press selects the higher temperature setting, indicated by two red lights on the switch.
- A second press selects the lower temperature setting, indicated by one red light.
- A third press turns the seat heater off; both indicator lights off.

The heater will automatically switch OFF after 10 minutes or if the ignition is turned OFF or a fault is detected.

The heater will maintain a pre-set temperature while it is switched on. Storage of the vehicle in a heated garage, body heat or warm ambient temperatures may prevent operation of the seat heater.

3-18 Before driving

Steering column adjustment



WARNING:

Do not adjust the steering column whilst driving.

The steering column can be adjusted for tilt and reach by operating the rotary/joystick control switch (A) on the left side of the steering column.

1. Turn the switch to the 'COLUMN' or 'AUTO' position.
2. Move the switch forwards or backwards to adjust reach.
3. Move the switch up or down to adjust tilt.

Two column positions may be stored and recalled by the driver position memory system. See **Memory setting** on page 3-24.

Entry/exit mode

Entry/exit mode provides automatic movement of the steering column and driver's seat to allow easier entry to or exit from the vehicle.

Entry/exit mode is selected by setting the steering column adjustment switch to the 'AUTO' position (B).

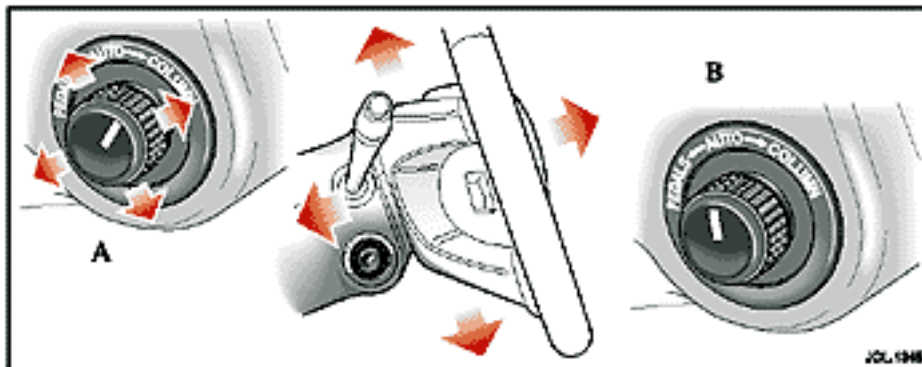

Exit – If the ignition key is in position '0' and the driver's door is opened or if the ignition key is removed, the steering column will move to the uppermost tilt position and the seat will move slightly rearwards.

Entry – When the key is next inserted in the ignition switch and the door is closed, the steering column and seat will return to their previous positions. If, however, the memorised driver position has been changed (using the door MEMORY switch or another key transmitter), the steering wheel and seat will move to the new position.

Caution: Do not use steering wheel mounted security devices since movement of the steering wheel in entry/exit mode could result in damage to the vehicle (e.g. the windscreen) or possible injury to the occupant.

Notes on entry/exit mode operation

1. If the adjustment switch is moved away from 'AUTO' whilst the steering column is tilted away, the steering column will move back to its memorised position when the key is next inserted in the ignition and entry/exit mode is then cancelled.
2. If the adjustment switch is moved during entry/exit operation, steering column movement will stop.

Pedal Adjustment



WARNING:

Do not adjust the pedals whilst driving.

This optional facility enables the pedals to be moved towards or away from the driver's seat, providing extra adjustment for the driving position. All pedals move together (no individual pedal adjustment) and are electrically controlled from the combined steering column/pedal adjust switch on the left side of the steering column housing. The adjustment can be made with or without the ignition key inserted.

To adjust the position of the pedals, turn the switch to 'PEDALS', then push it forwards or rearwards to cause a corresponding movement of the pedal assembly.

Two pedal positions may be stored and recalled by the driver position memory system. See **Memory setting** on page 3-24.

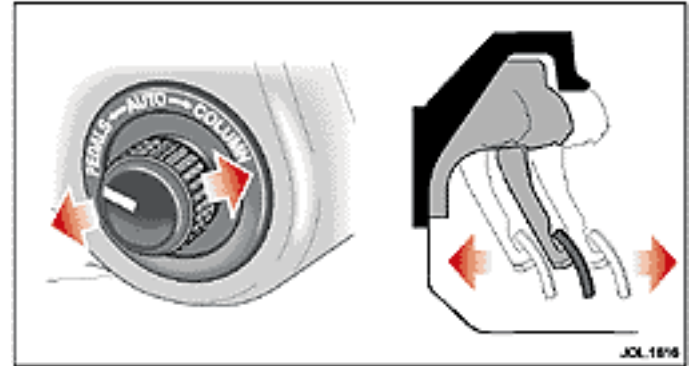

3-20 Before driving

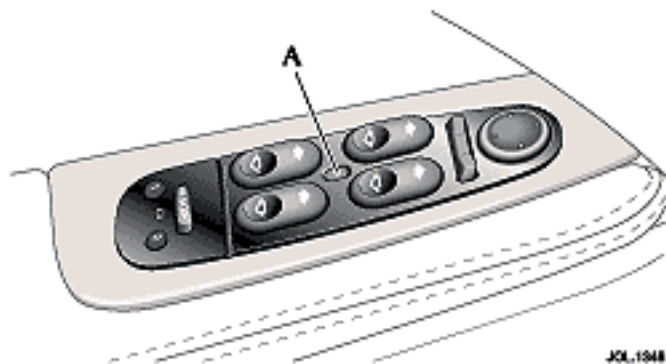

Window operation

The front and rear door windows are electrically operated.

Switches on the driver's door control all door windows.

Passengers are provided with a switch to control their door window only.

These switches will only operate the windows when the ignition switch is in position 'I' or 'II'.



WARNING:

1. When raising windows ensure all occupants are clear.
2. When leaving the vehicle take the ignition keys to prevent misuse of the window switches by remaining occupants, especially children.

Raise/lower

To lower a window, press and hold the rear of the switch until the desired position is reached, then release.

To raise a window, press and hold the front of the switch until the desired position is reached, then release.

If the switches are held for longer than 6 seconds, for example, when attempting to overcome frozen or jammed windows, the window drive will be switched off for a few seconds to protect the window drive motors.

One-touch operation

Each window has a 'one-touch' facility enabling the occupant to fully open or close the window in one quick movement.

Press the switch briefly to close or open the window in one movement. Window travel can be stopped at any time by pressing the switch again.

Immobilising the rear windows

The rear windows can be immobilised from the driver's door controls to prevent passengers from operating their windows.

To immobilise the rear windows, press button (A) down to the latched position i.e. flush with the bezel.

To enable rear window operation, press button (A) again so that it is in the raised position with the white band showing.

Window anti-trap protection

Each electrically operated window has an anti-trap protection feature. If the upward movement of the window detects an obstacle the anti-trap system will immediately stop the window closing, then move it downwards for a short distance.



WARNING:

If the battery is disconnected or discharged the window anti-trap feature is lost. When the battery is reconnected or recharged the window anti-trap system must be reset.

To reset the electrically operated windows anti-trap system

- Fully close the window, hold the switch in the close position for two seconds and then release the switch. Wait for two seconds, do not open the window.
- Again, select the same window to close, holding the switch for a further two seconds.
- Check to confirm the operation by opening the window and then use one touch operation to close the window.
- Repeat for the remaining electrically operated windows.

To override the anti-trap protection

The anti-trap system will also stop the window closing if a blockage or resistance occurs e.g. in the window guide channels. Typically this might be due to icing in winter but could also be caused by damage or mis-alignment of the guide channels or seals.

To override the anti-trap action:

- After the initial attempt to close the window, operate the close switch a second time.
- When the window has reversed from the blockage, operate the switch (within 10 seconds) until the window stops again (it will not reverse on the third attempt).
- Immediately operate the close switch again. The window will now move up a short distance with increased force to override the blockage.
- Repeat the override action until the window has closed. Each time the window stops, the switch must be operated immediately to initiate further override action.

If this procedure fails to move the blockage, the anti-trap feature will be lost and must be reset (see first column) after the blockage has been cleared.

Thermal overload

If the windows are repeatedly opened and closed (e.g. by a child), a protection system will de-activate window operation for a short period to avoid overheating of the window motors.

3-22 Before driving

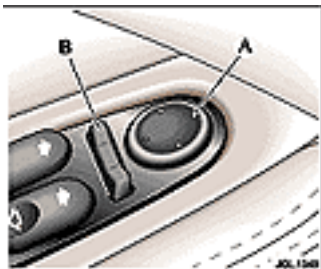

Mirrors

Door rear view mirrors

Both door mirrors are adjusted from the driver's door switchpack.

The four-way adjustment button (A) moves the mirrors to the required position. The selector switch (B) selects the mirror to be moved, left for the left-hand side mirror and right for the right-hand side mirror. When the selector switch is in the centre position, adjustment to either mirror is inhibited.

The mirror housings are designed to pivot against the vehicle upon impact.

To return the mirror to its normal position, manually reposition the housing until it locks into place.

Door mirrors – power fold back

To assist parking by reducing the overall vehicle width, an optional facility enables the door mirrors to be folded back.

Set mirror selector switch (B) to the centre position.

To fold the mirrors inwards, briefly press the rear of button (A). To return the mirrors to their normal driving position briefly press the front of button (A).

- Do not attempt to reposition power fold mirrors manually. Always use the button.
- If a door mirror is knocked out of position the mirror head will be loose. To re-engage the mechanism, power the mirror to the foldback position, then outwards to the drive position.

Caution: If door mirrors have been folded against the vehicle due to an impact:

- Reposition power foldback mirrors using the door switches.
- Reposition non-power fold back mirrors manually.

Mirror heating

The door mirrors have heating elements which work when the rear screen heater is switched ON. The mirror heater will clear all ice from the mirror surface.

Caution: Do not use a scraper to remove ice from the mirrors as this will damage the surface.

Electrochromic door mirrors

Electrochromic door mirrors are only fitted together with an electrochromic rear view interior mirror. The switches on the interior mirror control the electrochromic function for both door and interior mirrors (see following section).

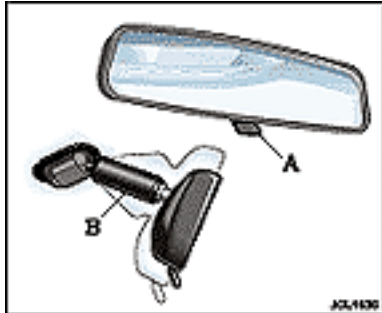

Interior rear view mirror

Interior mirrors are either the manual dip or electrochromic type.

Manual dip mirror

The interior rear view mirror can be dipped to prevent glare from a following vehicle's headlamps by pulling lever (A). Pushing the lever returns the mirror to its daytime setting.

Adjusting the mirror – The mirror is mounted on an adjustable arm (B) which can be angled to change the mirror height and lateral position.

Hold the arm and move to the desired position and then re-adjust the mirror itself.



Interior rear view mirror – electrochromic

The interior rear view mirror is of the electrochromic type, and is operated by two buttons at the base of the mirror.

When switched on, the mirror darkens automatically to prevent glare from a following vehicle's headlamps, and clears when light levels return to normal or when reverse gear is selected.

Where electrochromic door mirrors are fitted, they are operated in conjunction with the interior mirror by the same buttons and function in the same manner.

To operate: To switch on, press the AUTO button. An LED will illuminate to indicate that electrochromic operation is selected. Press the OFF button to switch off electrochromic operation.

Note:

1. Should a mirror assembly become detached from the windscreen, it must be refitted by a Jaguar Dealer.
2. Ensure that the windscreen in front of the mirror is kept clean. Where fitted, the moisture sensor for wiper operation is located to the front of the mirror casing. Any dirt may affect the operation of this sensor.

3-24 Before driving

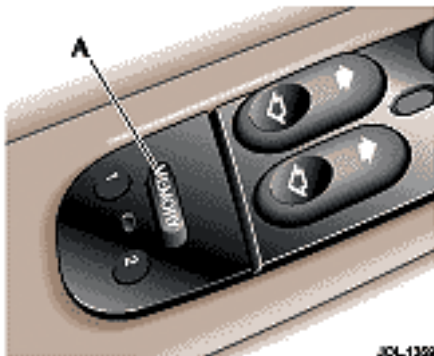

Memory setting

This optional facility enables the position of the driver's seat, steering column, pedals and exterior rear view mirrors to be memorised and recalled. Two different driving position profiles can be entered in the memory.

A key does not have to be in the ignition switch for seat, mirror, steering column or pedals adjustments, nor for memory setting.

Setting a driving position

To store a driving position in the memory:

1. Adjust the seat, steering column, pedals and exterior rear view mirrors to the desired positions.
2. Push the MEMORY button (A) and the red LED in the switchpack will illuminate for a five second period.
3. While the red LED is illuminated, push button '1', or '2' to memorise the configuration. The LED will go out and a chime will indicate that the setting procedure is complete. Additionally, if the ignition is on (position 'II'), the message centre will display a message that the settings have been saved.

By repeating these three steps and pressing the unused button ('1' or '2'), a further driving position can be stored in the memory.

To set a new driving position, adjust to the desired position and perform steps 2 and 3. The previous memory will be erased and the new position will be set.

Recalling a memorised position from the door switchpack

The gear selector lever in automatic transmission vehicles must be in 'P', and for manual transmission vehicles the parkbrake must be applied.

Press and release the appropriate memory button ('1' or '2'). The seat, steering column, pedals and door mirrors will move automatically to the memorised position.

Memory recall using a key-ring transmitter

The key-ring transmitter will recall a memory position when the unlock button is pressed when set as follows:

1. Adjust the seat, steering column, pedals and exterior rear view mirrors to the desired positions.
2. Press the MEMORY button: The red LED will illuminate for a five second period.
3. Press any button on the key-ring transmitter and then press button '1' or '2'. Both button presses must occur while the red LED is illuminated.
4. Repeat for the other transmitter, pressing the remaining memory button.

To cancel key-ring transmitter memory recall:

1. Press the MEMORY button: The red LED will illuminate for a five second period.
2. Press any button on the key-ring transmitter (except the panic button, if fitted) then press the MEMORY button again. Both button presses must occur while the red LED is illuminated.

Driving position memory system operating tips

- When making adjustments to a set driving position, reset the new position in the same memory channel.
- A driving position will only be memorised during the five second period when the red memory LED is illuminated.
- Previous memory is erased when a new driving position is entered.

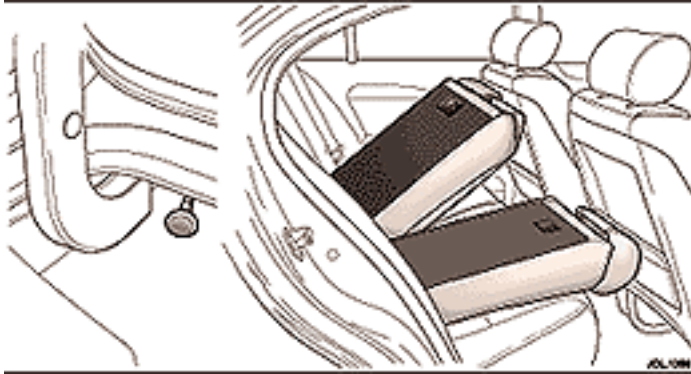

Ensure when folding the seat back down that the armrest is stowed and that there is sufficient clearance between the seat back, including the headrest, and the back of the front seat.

When returning the seat back to the upright position ensure that the seat belts are routed correctly and are not trapped by the seat back. Press the seat back firmly and check that it is locked securely into place.

Luggage compartment



WARNING:

1. **Locate heavy loads in the luggage compartment towards the front of the vehicle and secure them to stop them sliding. Loose items can be a hazard.**
2. **Do not drive with the luggage compartment lid open as exhaust fumes can be drawn into the passenger compartment.**

Rear seat back fold down

To provide a longer luggage compartment area, the backs of the rear seat on most models can be folded down in two parts to give a 70/30 width split.

Release handles for each seat back are in the luggage compartment under the parcel shelf.

Pull the selected side handle to release the seat back and then fold it onto the seat cushion.

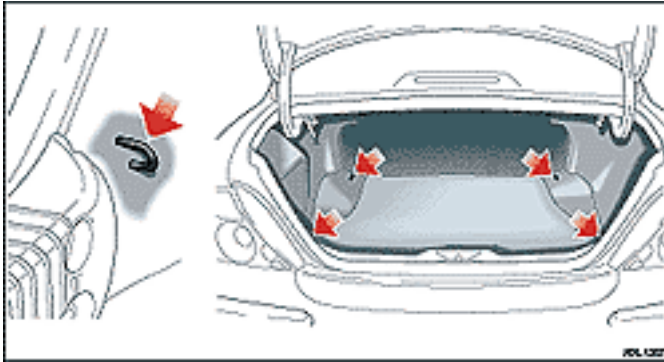

Luggage tie-down loops

Four metal loops are positioned in the luggage compartment for attaching straps to secure loads and prevent them from sliding over the luggage floor.

These loops are not to be used for securing passengers or animals nor as anchorages for child restraints.

A range of Jaguar storage accessories, including a luggage retaining net, are available from your Dealer.

It is advisable to distribute luggage weight evenly over the entire luggage floor area, particularly to prevent permanent damage to the seat trim when a seat has been folded down.

3-28 Before driving

Ski hatch

A two-door hatch is fitted to the rear seat on some models, providing an opening between the passenger and luggage compartments. This allows space for skis or similar objects to be stowed in the vehicle. Both doors have a single catch.

The inner door is accessible after folding down the armrest. To open the door, pull the leather flap forward, press the catch (A) downwards and gently lower the door on to the armrest.

A bag for retaining the skis can now be pulled from the receptacle into the passenger compartment, and the strap (C) loosened ready to accept the skis.

The other door is accessible from inside the luggage compartment and is opened by pushing the catch (B) and lowering the door.

Push the skis into the bag from the luggage compartment and then secure the skis using the strap provided on the bag. Clip the strap connector (D) to the centre rear seat belt buckle.

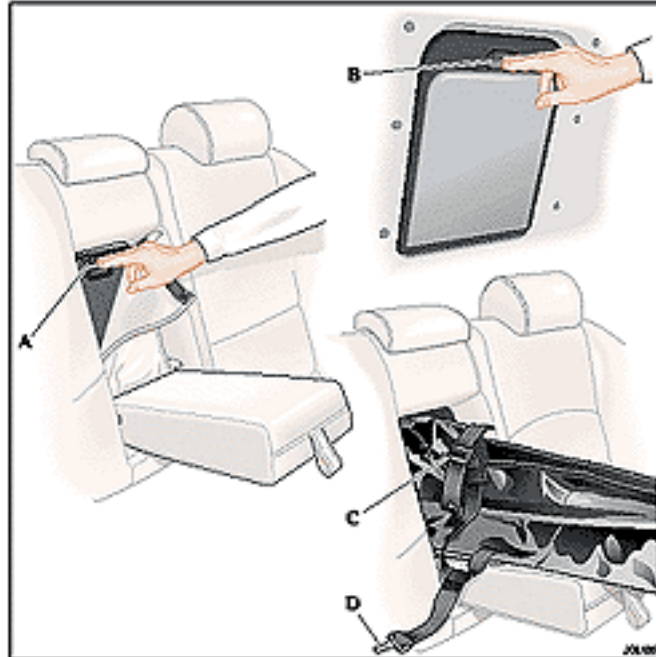



Odometer (C)

Records the total distance covered by the vehicle.

The odometer reading is displayed below the speedometer, along with the trip distance since it was last reset. To reset the trip distance, press the reset button on the trip computer switchpack. The trip distance will roll-over at 999.9 miles (or 999.9 kilometres).

The odometer is displayed in the message centre unless a message has priority or a trip computer function has been selected.

Fuel level gauge (D)

Indicates the amount of fuel in the tank.

A warning message is displayed in the message centre when the fuel in the tank is at a low level and should be refilled. Simultaneously, the amber general warning light to the left of the message centre will light up.

The small arrow, shown beside the fuel pump symbol, identifies on which side of the vehicle the filler cap is located.

Instruments

None of the instruments will show correct indications until the ignition is switched ON (position 'II').

If the exterior light switch is ON the display brightness can be varied using the dimmer switch (see page 4-29).

Speedometer (A)

Speed indication is in either:

- Miles per hour, the outer figures, and kilometres per hour, or;
- Kilometres per hour, the outer figures, and miles per hour, or;
- Kilometres per hour only.

Tachometer (B)

The tachometer indicates engine speed in revolutions per minute and is calibrated in increments of 250 rev/min extending to 8000 rev/min.

Caution: Do not allow the needle to enter the red sector.

4-2 On the road

Engine Temperature (E)

Drive at moderate road and engine speeds until normal operating temperature is reached. This is indicated when the pointer is between the blue (cold) segment and the red (hot) segment.

The engine operating temperature will vary with changes in weather and engine load. The engine temperature may rise in some circumstances, such as:

- Idling for long periods in slow moving traffic.
- Driving up a long hill in hot weather.
- Driving slowly or stopping after driving at high speed.
- Towing a trailer or caravan.



WARNING:

1. **The radiator cooling fans may continue to run after the ignition has been switched off but will automatically switch off when the engine has cooled sufficiently.**
2. **It is unsafe to run the engine in an overheated condition.**

3. **Do not remove the coolant reservoir filler cap while the engine is hot. If it is essential, then protect your hands against escaping steam. SLOWLY turn the cap anti-clockwise to allow the steam pressure to escape completely before removing the cap.**

Should the pointer move into the red segment (**H**) of the coolant gauge or if the message 'HIGH ENGINE TEMPERATURE' with a RED priority light is displayed, stop the vehicle as soon as it is safely possible, turn off the engine and open the hood to allow the engine to cool.

Note: To assist cooling, high engine temperature automatically turns off the air conditioning. To maintain some cooling it is advisable to switch the air distribution to 'recirculation'.

Warning lights

Warning lights are arranged within the instrument cluster.

There are two warning lights, one red, the other amber, located one on each side of the message centre for primary and secondary status of the warnings displayed by the message centre.

'RED' warning lights are for primary warnings. A primary warning must be investigated immediately by the driver or a Jaguar Dealer.

'AMBER' warning lights are for secondary warnings when the driver must take action and then report the fault to a Dealer at the earliest opportunity.

Other lamps within the instrument cluster indicate system status, such as blue for main beam and green for direction indicators, when in operation.

Lamp check

A lamp check is initiated when the ignition is switched ON and lasts for three seconds (excepting the airbag warning light which will remain on for 6 seconds). If any warning light remains on after this period, investigate the cause before driving.

When activated, some warning lights have associated messages displayed on the message centre.

Note: Not all lamps are included in the lamp check, for example main beam headlamps or direction indicators.



Low oil pressure

This lights up with the ignition switched ON and will stay on until the engine is running.

If the warning light stays ON when the engine is running, loss of oil pressure is indicated. STOP the engine immediately and investigate the cause.

Caution: Do not restart the engine until the cause of loss of oil pressure has been identified and rectified.

First check the engine oil level, see Section 7.



Charge indicator

Lights up when the ignition is ON and should go out when the engine is running.

If the light stays ON when the engine is running it indicates that there is either a battery voltage fault or an alternator fault.

Turn OFF all electrical accessories, radio, climate control, rear screen heater etc. Try to use the minimum electrical load as possible such as power windows, electric sunroof etc.

Report the fault to a Jaguar Dealer.

4-4 On the road



Seat belt

Illuminates when the ignition is ON and the driver's seat belt is not fastened. If the warning light stays ON with the seat belt fastened, report the fault to a Jaguar Dealer. It is safe to drive the vehicle with the light ON, provided that the seat belt is properly fastened.

Ensure that all occupants seat belts are fastened before driving.



Brake

Lights up when:

- The ignition is ON and the parkbrake is ON,
- And/or the brake fluid is low,
- And/or there is a fault with the electronic brake system.



WARNING:

DO NOT drive the vehicle until the fault is rectified. Consult a Jaguar Dealer immediately.

If the light is ON with the parkbrake OFF and a 'LOW BRAKE FLUID' message with a RED priority light is displayed on the message centre, low brake fluid is indicated. In this case, loss of braking assistance in one, or both, brake circuits may be imminent.

If the light is ON with the parkbrake OFF and no message is displayed then there is a fault with the electronic brake distribution system.

If the light flashes, there is a fault with the parkbrake system and the parkbrake cannot be applied.

If the light is ON with the ABS light also ON then the electronic brake system may not function correctly, which can impair stability when the brakes are applied.

If the light flashes this also indicates a fault with the brake system.



Anti-lock braking system (ABS)

If a fault has been detected in the anti-lock brake system (ABS) this light will illuminate. The brake system will continue to function normally, but without ABS braking.

Should the light come on or stay on after the bulb check cycle, stop the vehicle at the first opportunity, turn the engine OFF and then restart.

If the ABS light comes on again, the vehicle should be driven to a Jaguar Dealer at the earliest opportunity.



Traction control/DSC

The light will flash at the rate of twice a second when traction control/DSC is operating.

The message 'TRACTION CONTROL FAULT' or 'DSC NOT AVAILABLE' will be displayed and the light will be ON continuously when a fault is detected in the system.

If the system is turned OFF, a message 'TRACTION CONTROL OFF' or 'DSC OFF' will be displayed for 4 seconds and the warning light will remain ON.



Engine malfunction

This lamp illuminates when there is an engine malfunction.

Specialised diagnostic equipment is required to repair such faults. Report the fault to a Jaguar Dealer.

The vehicle may go to 'limp home' mode, with the possibility of reduced engine performance. Drive the vehicle with caution.



Adaptive cruise control (where fitted)

If adaptive cruise control is active, lights up to indicate that the vehicle is in 'follow mode' and automatically maintaining the desired gap to the vehicle immediately ahead.

Only applicable to vehicles fitted with adaptive cruise control.



Airbag

If the airbag system develops a fault, the warning light will flash and then come ON and remain on until the fault has been diagnosed and cleared.

Report the fault to a Jaguar Dealer immediately.

It is safe to drive the vehicle; however, in an accident the airbags may not operate.



Main beam

Illuminates when the main beam headlamps are switched ON or flashed ON.

4-6 On the road



Front fog lamps

Illuminates when the front fog lamps are switched ON.



Rear fog lamps

Illuminates when the rear fog lamps are switched ON.



Direction indicators

The appropriate indicator tell-tale will flash when the column switch is moved up or down to signal a right or left-hand turn. If a direction indicator fails, the tell-tale will flash at twice normal rate when that indicator is selected. Fit a new bulb immediately.

Note: If a bulb has failed, the audible ticking will sound at twice the normal rate.

Hazard warning lamps

When the hazard warning is selected, both direction indicator tell-tales flash simultaneously.

Audible warnings

Various sounds are produced for warning and notification purposes as follows:

Hazard or Condition	Remedy/chime or tone
External lamps remain ON when the driver's door is opened.	A chime will sound until the lights are switched OFF or driver's door is closed. Note: The chime will not sound if the switch is in Autolamp position.
Hazard warning indicators ON.	A ticking will sound until the hazard indicators are switched OFF.
Left or right direction indicators ON.	If the switch has not turned itself OFF, switch the turn indicator OFF when the manoeuvre is completed. A ticking will sound until the indicators are switched OFF.
Memory 1 or 2 configuration saved.	A short tone as the memory selection is saved.
Airbag system failure.	A tone sequence is repeated five times. Report the fault to a Jaguar Dealer as soon as possible.
Seat belt reminder.	A chime will sound until the driver's seat belt is fastened or the ignition switch turned to '0'.
Electric parkbrake.	If the parkbrake is applied whilst the vehicle is moving; push the switch to release the parkbrake.
ACC Driver intervene.	Where fitted, action is required by the driver to apply the brakes.

4-8 On the road

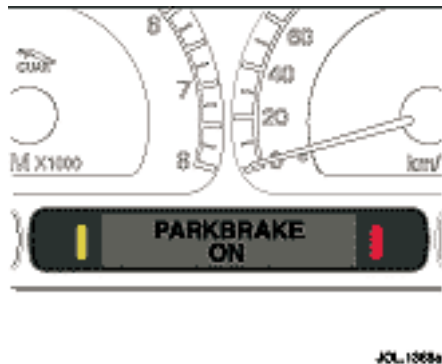

Message centre

Driver information, messages and data are displayed on the message centre display panel situated within the instrument cluster.

For the message centre to operate the ignition must be switched ON (position 'II').

The primary function of the message centre is to inform the driver of the following:

- Warning messages.
- Temporary alert messages.
- Information messages.

The message centre displays:

- The total distance covered by the vehicle.
- Trip computer information.
- Warning messages if system faults are detected.
- Status messages to indicate changes in state of certain vehicle functions.

Messages



WARNING:

If a red warning light is displayed, stop the vehicle as soon as possible but only when it is safe to do so.

Most messages, when displayed, have an associated warning light, red or amber, to the left or right of the display which will come on to indicate the message priority.

If more than one message is active, each is displayed in turn for two seconds in order of priority.

Messages take priority over the odometer reading or trip computer data and, if active, will be displayed when the ignition is switched ON.

Message centre illumination

The message centre is lit at all times when the ignition is ON.

All information displayed will be brightly lit if the exterior light switch is OFF.

Note: Warning lights and warning messages are always brightly lit and are not affected by the dimmer switch.

Messages

The tables on this and the following pages list all messages and warning lights and explains their meaning.

Message	Warning Light	Priority Indicator	Meaning
LOW BRAKE FLUID	Brake	Red	Displayed when the brake fluid level is low. Complete loss of braking may occur.
ENGINE COOLANT LOW	None	Red	Displayed when the coolant level in the reservoir is too low. Check temperature gauge often. The coolant reservoir should be replenished at the earliest opportunity and any leaks repaired.
HIGH ENGINE TEMPERATURE	Engine Overtemp	Red	Displayed when engine temperature becomes excessive. Pull off the road when safe to do so and allow the engine to cool.
RESTRICTED PERFORMANCE	None	Red	This will be displayed when the vehicle has possible loss of power or driveability. Report the fault to a Jaguar Dealer.
ENGINE SYSTEMS FAULT	Malfunction Indicator lamp	Red	Displayed when the engine has defaulted to 'limp home' mode. Report the fault to a Jaguar Dealer at the earliest opportunity.
DRIVER'S or PASSENGER'S FRONT OR REAR DOOR OPEN	None	Red	Check that all doors are closed before driving.

4-10 On the road

Message	Warning Light	Priority Indicator	Meaning
TRUNK OPEN	None	Red	Check that the luggage compartment lid is closed before driving.
ABS FAULT	ABS	Amber	ABS will not be available. The braking system will work but care must be used if braking heavily.
STEERING COLUMN LOCKED	None	Amber	The steering lock system has failed to unlock the steering column. The engine cannot be started. Remove the key and re-insert it into the ignition switch, then try again to unlock the column by turning the steering wheel gently to the left and right (only small movements will be possible).
HIGH TRANSMISSION TEMPERATURE	None	Amber	Displayed when the gearbox temperature is extremely high. The transmission will attempt to limit the rise in temperature but the driver will experience a degradation of transmission operation. The driver can assist by decreasing the power demand to the engine.
TRANSMISSION FAULT	None	Amber	It is likely that the driver will experience a degradation of transmission operation.
TRACTION CONTROL FAULT	Traction Control	Amber	Displayed when a fault occurs in the traction control system.
TRACTION CONTROL ON or OFF	Traction Control	Amber (OFF only)	Displayed when the traction control system is switched ON or OFF. The warning light will FLASH when the traction control system is switched ON and operating. When the system is switched OFF, the warning light in the instrument cluster will be illuminated until the system is switched back ON.

Message	Warning Light	Priority Indicator	Meaning
DSC NOT AVAILABLE	Stability Control	Amber	Displayed when a fault occurs in the stability control system.
DSC ON or OFF	Stability Control	Amber	Displayed when the stability control system is switched ON or OFF. The warning light will FLASH when the stability control system is switched ON and operating. When the system is switched OFF, the warning light in the instrument cluster will be illuminated until the system is switched back ON.
LOW FUEL LEVEL	None	Amber	Fill the tank at the earliest opportunity.
CATS SYSTEM FAULT	None	Amber	Displayed when a fault is detected in the adaptive damping system (only those vehicles fitted with adaptive damping suspension). Report the fault to a Jaguar Dealer at the earliest opportunity.
WASHER FLUID LOW	Low washer fluid level	Amber	Replenish the washer fluid at the earliest opportunity.
<p>Note: In most countries it is illegal to use a vehicle with a defective exterior lamp bulb. Bulb replacement information is shown in Section 6.</p>			
LEFT or RIGHT BRAKE LAMP FAILED	None	Amber	Check for failed brake lamps and replace.

4-12 On the road

Message	Warning Light	Priority Indicator	Meaning
LEFT or RIGHT TAIL LAMP FAILED	None	Amber	Check for any failed tail lamps and replace.
FAILED LEFT or RIGHT FRONT INDICATORS	None	Amber	Check for any failed front direction indicator lamps and replace.
FAILED LEFT or RIGHT REAR INDICATORS	None	Amber	Check for any failed rear direction indicator lamps and replace.
FAILED LEFT or RIGHT SIDE REPEATER	None	Amber	Check for failed side direction indicator repeater lamps and replace.
CHECK FUEL FILLER CAP	None	Amber	The fuel filler cap may be loose or leaking excessively.
APPLY PARKBRAKE	None	Amber	If the battery has been disconnected then the parkbrake must be applied to reset the system.
PARKBRAKE FAULT	None	Amber	Displayed when there is a fault in the parkbrake system. If the light is flashing the parkbrake cannot be applied.

Message	Warning Light	Priority Indicator	Meaning
PARKBRAKE ON	None	None	Displayed if the parkbrake is applied whilst the vehicle is moving above 3 mph (5 km/h).
LISTENING	None	None	When Voice Activation has been selected and the system is waiting for a voice command/input.
COLUMN ADJUST	None	None	The column adjust switch has been moved to this position.
COLUMN ADJUST AUTO	None	None	The column adjust switch has been moved to this position.
PEDAL ADJUST	None	None	The column adjust switch has been moved to this position.
PEDAL ADJUST INHIBITED	None	None	The pedals cannot be adjusted when the vehicle is in cruise control operation.
AUTOLAMP DELAY OFF	None	None	Autolamp delay function has been turned off.
AUTOLAMP DELAY X:XX	None	None	Changing the time delay will display the newly set time that the headlights will remain ON after exiting the vehicle.

4-14 On the road

Message	Warning Light	Priority Indicator	Meaning
MEMORY 1 or MEMORY 2 RECALLED MEMORY 1 or MEMORY 2 SETTINGS SAVED	None	None	When a memory is set or recalled, a corresponding message will be displayed.
CRUISE ENGAGED	None	None	Displayed when cruise control system is operating.
CRUISE CANCELLED	None	None	Driver has cancelled cruise control or is braking.
CRUISE OVERRIDE	None	None	Driver is pressing the accelerator pedal.
The following messages only apply to vehicles fitted with adaptive cruise control.			
DRIVER INTERVENE		Red	Action by the driver to apply the brakes is required.
SETSPEED XXX MPH		None	Speed set for adaptive cruise control.

Message	Warning Light	Priority Indicator	Meaning
GAP ← — →		None	Set the distance (time gap).
ACC SENSOR BLOCKED		Amber	Clean the front of the vehicle in the area of the sensor unit (the sensor is mounted behind the left-hand cover in the lower cooling air inlet).
CRUISE NOT AVAILABLE		Amber	Adaptive cruise malfunction.
FORWARD ALERT OFF		None	Forward alert feature has been switched OFF.  WARNING: A warning will not be given for objects detected in the vehicle path of travel.
FORWARD ALERT ← — →		None	Forward alert feature has been switched ON or the setting changed. A warning will be given for objects detected in the vehicle path of travel. A longer gap indicates that the system will warn when detected objects are further away than the previous setting.

4-16 On the road

Trip computer

The computer memory stores data for a journey or series of journeys until it is reset to zero.

The displayed information is for guidance only, as it can be affected by traffic, road and weather conditions.

Two independent memories are available (A and B) to allow two separate journeys to be recorded concurrently, for example, work usage and evening/weekend usage.

Trip distance, average fuel economy and average speed will be prefixed A or B depending on the current memory selected.

Press the TRIP button on the end of the left column stalk switch repeatedly to display the data in the following order:

- Odometer.
- Trip distance.
- Distance to empty.
- Average fuel economy.
- Average speed.
- Messages.
- Clock.

Odometer

The odometer shows the total vehicle distance travelled since the vehicle was new.

When the ignition is switched ON (position 'II') the display shows the odometer and trip distance readings.

The odometer reading is displayed in either miles or kilometres, depending on the units selected with the trip computer.

Trip distance (A/B)

Distance travelled since the last memory reset. The maximum trip reading is 9999.9 miles (16090 kilometres). The computer will automatically reset to zero if this distance is exceeded.

Distance to empty

Predicted distance, miles or kilometres, that the vehicle should travel on the remaining fuel, assuming average fuel economy and fuel consumption stay constant.

Average fuel economy (A/B)

The average fuel consumption, miles per gallon, or litres per 100 kilometres, based on the accumulated distance travelled and the accumulated fuel used.

Average speed (A/B)

The average speed since the last press of the reset button.



Trip computer switchpack

mI/Km

Pressing the 'mI/Km' switch alternately displays data in metric or imperial units.

A/B

Selects either A or B trip memory. Select the required data using the column stalk TRIP button and then pressing A/B will show the A or B information for that data.

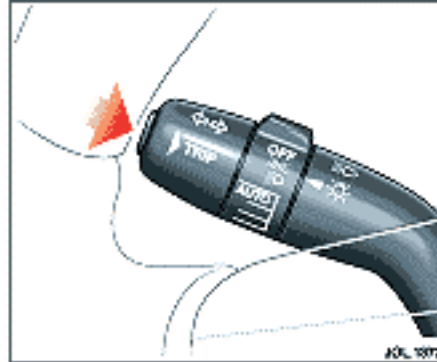

RESET

- One short press clears (hides) the displayed message. Continue to give brief presses to clear one message after another until all messages are cleared.
- Press and hold for three seconds to reset or clear the selected trip, A or B, to zero.

Note: If warning messages are hidden, the warning/fault still exists and requires investigation.

Warning and Information messages have priority over trip data and, if active, will be displayed when the ignition is at position 'II'.

It also can be used to cycle through: TRIP – ODOMETER – MESSAGES.

Setting the trip computer

At the start of the journey, or series of journeys, to be recorded, reset the computer memory to zero as follows:

1. Press the TRIP button on the end of the left column stalk switch to select a trip function. The computer will display either TRIP A: or TRIP B: data.
2. Press the A/B switch to select the trip (A or B) to be reset.
3. Press the RESEt switch and hold for 3 seconds.

The display will read:

RESETTING

TRIP A (or B).

Then it will reset and display:

A: 0 (or B: 0) or the new value.

Note: All trip functions, for A or B depending on which was selected, will be reset.

4-18 On the road

Clearing messages

Messages can be hidden by pressing RESET on the trip computer switchpack. One press will hide one message. Once all messages have been hidden, the display will show trip data, a further press will display the odometer reading.

If RESET is pressed again, all active messages will be 're-displayed'. Repeatedly pressing the RESET button will cycle through the trip, odometer and message modes.

If a fault occurs when in trip computer or odometer mode, the relevant message will be displayed immediately.

If a trip computer function is selected by pressing the TRIP button while messages are displayed, the trip data will be displayed for 10 seconds, then the message will reappear.

Hidden messages reappear after an ignition OFF/ON cycle, if the fault remains.

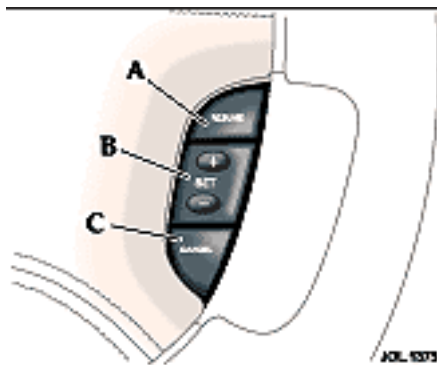

Cruise (speed) control

The cruise (speed) control system, when fitted, can be used by the driver to maintain a selected vehicle speed above 16 mph (26 km/h) without the driver having to use the accelerator.

Switches on the steering wheel allow the driver manual control of the system. Brake and clutch operation also influences the cruise control system.

(A) – RESUME to resume the set speed retained in memory.

(B) – SET to set the speed or increase/decrease the set speed when the speed has been set.

(C) – CANCEL cancels cruise control but retains the set speed in memory.

Setting vehicle speed



WARNING:

Only use cruise control when conditions are favourable, for example, straight, dry, open roads with light traffic.

When you are travelling at the speed you require, which must be above 16 mph (26 km/h), press the SET button.

Cruise control will engage and maintain the set speed and you can remove your foot from the accelerator pedal.

Note: Cruise control will automatically disengage when the brake pedal is pressed or when the vehicle speed falls below 16 mph (26 km/h). If the vehicle has a manual gearbox, pressing the clutch pedal will also disengage the cruise control.

Changing the set speed

There are three ways to change the set speed:

1. Accelerate or decelerate to the desired speed then press the SET (+) button.
2. Increase or decrease the speed by pressing and holding either SET (+) or (-) until the desired speed is obtained, then release the switch.
3. Increase or decrease the speed in steps of 1 mph (2 km/h) by briefly pressing either the SET (+) or (-) until the desired speed is obtained.

Resuming the set speed

If the vehicle is accelerated above the set speed, then the set speed will be resumed when the accelerator pedal is released.

If CANCEL is pressed, or the brake or clutch pedal is pressed, the cruise control will disengage but the set speed memory will be retained. Press RESUME and the vehicle will return to the set speed.

Note: Cruise control will not resume at speeds below 16 mph (26 km/h).

RESUME will not operate if the ignition has been turned off.

Caution:

1. **RESUME should only be used if the driver is aware of the set speed and intends to return to it.**
2. **It is not recommended to resume set speed when a low gear is selected as excessive engine speeds will occur.**

Cruise control will switch off and clear the memory when:

- The ignition is switched to position '0'.
- A fault occurs. The cruise control system will switch OFF and cannot be used until the fault is cleared.

Cruise control automatic switch off

Cruise control will switch off but the set speed will remain in the memory when:

- The CANCEL button is pressed.
- The brake pedal is pressed.
- The parkbrake is applied.
- Speed falls below 16 mph (26 km/h).
- Neutral, Park or Reverse gear positions are selected.
- Traction control or DSC is operating.
- The difference between the actual and set speed is too great.
- When the vehicle reaches a maximum speed of:

Manual	125 mph (200 km/h)
Auto	120 mph (192 km/h).
- The accelerator pedal is used to accelerate beyond the set speed for too long a period.
- If the vehicle has a manual gearbox, pressing the clutch pedal will also disengage the cruise control.

4-20 On the road

Adaptive cruise control (ACC)

(Where fitted)

The adaptive cruise control system is designed to aid the driver to maintain a gap from the vehicle ahead or a set road speed if there is no slower vehicle ahead. The system is intended to provide enhanced operation of the vehicle when following other vehicles which are in the same lane and travelling in the same direction.



WARNING:

Adaptive cruise control is not a collision warning or avoidance system. Additionally, adaptive cruise control will not detect:

- 1. Stationary or slow moving vehicles below 6 mph (10 km/h).**
- 2. Pedestrians or objects in the roadway.**
- 3. Oncoming vehicles in the same lane.**

The adaptive cruise control system is based on the use of a radar sensor which projects a beam directly forward of the vehicle so as to detect objects ahead. The radar sensor is mounted behind a cover on the left-hand side of the lower cooling aperture, to provide a clear 'view' forward for the radar beam.



JOL1620

- Only use adaptive cruise control when conditions are favourable, that is, straight, dry, open roads with light traffic.
- Do not use in poor visibility, specifically fog, heavy rain, spray or snow.
- Do not use on icy or slippery roads.
- It is the drivers responsibility to stay alert, drive safely and be in control of the vehicle at all times.
- Keep the front of the vehicle free from dirt, metal badges or objects, including vehicle front protectors, which may prevent the sensor from operating.
- Do not use ACC when entering or leaving a motorway.

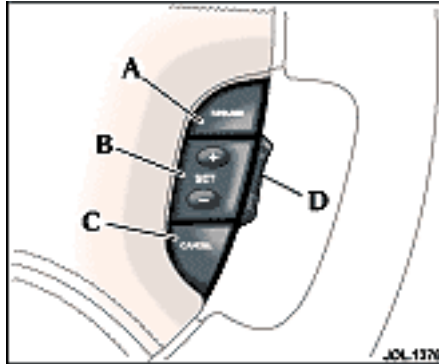

The system is operated by switches mounted on the steering wheel. The driver can also intervene at any time by use of the brake or accelerator pedals. The steering wheel switches operate as follows:

- (A) **RESUME**: Resume set speed.
- (B) **SET +** or **SET -**: Set the speed (+) or increase (+) or decrease (-) the set speed.
- (C) **CANCEL**: Cancels without erasing memorised speed.
- (D) Gap increase or decrease.

Setting a speed

Accelerate as normal until the required speed is reached.

Press the 'SET +' button (A) briefly and the vehicle speed will then be stored in the memory and the system engaged. The set speed will be displayed on the message centre.



Entering the follow mode



WARNING:

When in follow mode the vehicle will not decelerate automatically to a stop, nor will the vehicle always decelerate quickly enough to avoid a collision without driver intervention.

Once a set speed has been selected, the driver can release the accelerator and the set road speed will be maintained.

When a vehicle ahead enters the same lane or a slower vehicle is ahead in the same lane, the vehicle speed will be adjusted automatically until the gap to the vehicle ahead corresponds to the preset gap. The vehicle is now in 'follow mode'.



The warning light in the instrument cluster will be illuminated.

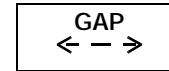

And the message centre will display the gap set.

The vehicle will then maintain the constant time gap to the vehicle ahead until:

- The vehicle ahead accelerates to a speed above the set speed.
- The vehicle ahead moves out of lane or out of view.
- The vehicle ahead slows so that 'low speed automatic switch off' occurs.
- A new gap distance is set.

If necessary, the vehicle brakes will be automatically applied to slow the vehicle to maintain the gap to the vehicle in front.

4-22 On the road

The maximum braking which is applied by the ACC system is limited and can be overridden by the driver applying the brakes, if required.

Note: Driver braking will cancel adaptive cruise control.

If the ACC system predicts that its maximum braking level will not be sufficient, then an audible warning will sound while the ACC continues to brake. This is accompanied by a red warning light and 'DRIVER INTERVENE' will be displayed on the message centre. The driver should take IMMEDIATE action.

When in follow mode the vehicle will automatically return to the set speed when the road ahead is clear, for instance when:

- The vehicle in front accelerates or changes lane.
- The driver changes lane to either side or enters an exit lane.

The driver should intervene if appropriate.

Low speed automatic switch off

If the speed of the vehicle decreases below 18 mph (30 km/h), the ACC system will be automatically switched OFF and the instrument warning lamp will go out.

If the brakes were being applied by the ACC system, they will be slowly released.

This will be accompanied by an audible warning, a red warning light and 'DRIVER INTERVENE' will be displayed on the message centre. The driver must take control.

Overriding the set speed/follow mode



WARNING:

Whenever the driver is overriding the ACC by depressing the accelerator pedal, the ACC will not automatically apply the brakes to maintain separation from any vehicle ahead.

The set speed and gap can be overridden by pressing the accelerator pedal when cruising at constant speed or in follow mode. If the vehicle is in follow mode, the instrument warning lamp will go out when the ACC is overridden by the driver using the accelerator and 'CRUISE OVERRIDE' will be displayed on the message centre. When the accelerator is released the ACC function will operate again and vehicle speed will decrease to the set speed, or a lower speed if follow mode is active.

Changing the set speed

There are three ways to change the set speed:

1. Accelerate or brake to the required speed and press the 'SET +' button (A).
2. Increase or decrease the speed by pressing and holding either the 'SET +' or '-' button until the required set speed is shown on the message centre. The vehicle speed will gradually change to the selected speed.
3. Increase or decrease the speed in steps of 1 mph (2 km/h) by briefly pressing the 'SET +' or '-' button.

ACC operates between approximately 20 mph and 110 mph (34 km/h and 180 km/h) dependent on the country specification.

Set speeds outside this range will not be captured.

The ACC may apply the brakes to slow down the vehicle to the new set speed. The new set speed will be displayed on the message centre for four seconds after it has been changed.

Changing the gap

The gap from the vehicle ahead can be decreased or increased by pressing the rocker switch (D) on the steering wheel. Four gaps are available and the selected gap setting will be displayed on the message centre when either button is pressed. After the ignition is switched ON the default gap will be automatically selected ready for ACC operation.

Note: It is the driver's responsibility to select a gap appropriate to the driving conditions.

ACC automatic switch off

Adaptive cruise control will disengage, but not clear the memory when:

- The CANCEL button (C) is pressed.
- The brake pedal is pressed.
- The vehicle speed falls below 18 mph (30 km/h).
- Neutral, Park or Reverse gear positions are selected.
- The parkbrake is applied.
- Traction control is activated.

Adaptive cruise control will disengage, and clear the memory when:

- The ignition switch is set to position '0'.
- Maximum vehicle speed is reached.
- A fault occurs in the ACC system.

Resuming the set speed/follow mode

By pressing the resume button (A) after ACC has been cancelled, for example, after braking, the ACC will become active again provided that the set speed memory has not been erased. The set speed will be displayed for four seconds and the original set speed will be resumed, unless a vehicle ahead causes the follow mode to become active.

Caution: 'RESUME' should only be used if the driver is aware of the set speed and intends to return to it.

Forward alert

Limited detection and warning of stationary objects is provided in addition to the existing ACC 'DRIVER INTERVENE' warning.

If a stationary object is detected ahead while ACC is engaged, then a warning message and tone will be issued but the brakes will not be applied.

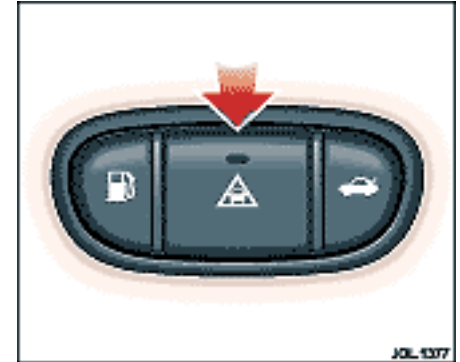

When ACC is not engaged, a warning of stationary or moving objects will be issued if detected by the ACC radar unit.

This additional feature may be switched on or off using the forward alert switch in the lower outboard knee bolster switchpack.

When the indicator lamp in the switch is on, forward alert is active.

4-24 On the road

The sensitivity of the warning may be changed:

- Pressing the gap decrease button (D) when ACC is disengaged displays and then decreases the radar sensitivity.
- Pressing the gap increase button displays and then increases the radar sensitivity.

Both of these are accompanied by the FORWARD ALERT ← — → message on the message centre.

ACC failure

If a fault occurs during operation of the system in cruise or follow modes, the ACC system will switch OFF and cannot be used until the fault is cleared. A red warning light and the message 'DRIVER INTERVENE' appear briefly, and are then replaced by an amber warning light and the message 'CRUISE NOT AVAILABLE'.

If failure of the ACC or any related system occurs at any other time an amber warning light will be displayed accompanied by the message 'CRUISE NOT AVAILABLE'. It will not be possible to activate the ACC system in any mode.

Accumulations of dirt, snow or ice on the on the sensor or cover may inhibit ACC operation. Fitting of a vehicle front protector or metallised badges may also affect ACC operation.

If this occurs in ACC cruise/follow mode, the red warning light is displayed, the audible alarm sounds and the message 'DRIVER INTERVENE' appears briefly. These warnings are then replaced by the amber warning light and the message 'ACC SENSOR BLOCKED' is displayed. The system is no longer active.

Clearing the obstruction allows the system to return to normal operation. If the obstruction is present when ACC is inactive, e.g. on initial starting or with the ACC system switched off, the amber warning light will be displayed with the message 'ACC SENSOR BLOCKED'.

Tyres other than those recommended may have different sizes. This can affect the correct operation of the ACC.

Notes on using adaptive cruise control

1. Adaptive cruise control operates when the gear selector lever is in position '2', '3' '4' '5' or 'D'.
2. When engaged, the accelerator pedal rests in the raised position. Fully release the pedal to allow normal ACC operation.
3. When braking is applied by the ACC the brake pedal will move down and up as braking is applied or removed. The vehicle brake lights will be switched on while braking is applied.



WARNING:
The driver must not rest a foot under the brake pedal, as it may become trapped.

Driving with ACC active

The system acts by regulating the speed of the vehicle using engine control and the brakes. Gear changes may occur in response to deceleration or acceleration whilst in ACC.

ACC is not a collision avoidance system, however, during some situations the system may provide the driver with an indication that intervention is required.

An audible alarm will sound, accompanied by a red warning light and the message 'DRIVER INTERVENE' if the ACC detects:

- That using maximum ACC braking only is not sufficient
- That the vehicle speed has decreased below the minimum for ACC operation
- A failure has occurred whilst the system is active

Detection issues can occur:

- When driving on a different line to the vehicle in front (A).
- With vehicles which edge into your lane which can only be detected once they have moved fully into your lane (B).

There may be issues with the detection of vehicles in front when going into and coming out of a bend (C).

In these cases ACC may brake late or unexpectedly. The driver should stay alert and intervene if necessary.

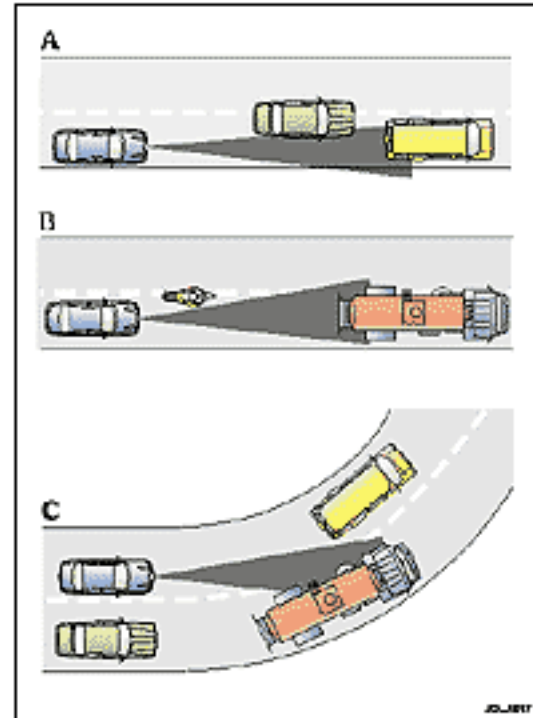



Exterior lighting

Master lighting rotary switch positions

- OFF
- Side (parking) lights
- Headlights
- Autolamps/exit delay

The exterior lights are controlled by the left-hand column stalk switch.

The rotary collar on the stalk has three positions for turning the exterior lights on or off and positions for autolamps/exit delay. These are:

OFF – All exterior lights OFF (except vehicles provided with daylight running lights).

Sidelights – Switches on front sidelights, tail, number plate and any other marker lights required by local legislation. When the external lights are ON the instruments will also be lit.

Headlights – With the ignition in position 'II', this position switches on dipped headlights in addition to the lights switched on in sidelight position.

The left-hand column stalk switch has two positions for controlling the main beam.

Pulling the switch towards the steering wheel and releasing causes the main beam to flash on and off. The main beam can be flashed at any time when the switch is pulled and will remain ON for as long as the switch is held.

The second position is to switch main beam headlights ON. With the ignition in position 'II', first select dipped beam lights, and then push the column light switch away from the steering wheel.

The blue warning light on the instrument cluster and main beam headlights will come ON.

To turn main beam OFF, pull the column switch towards the steering wheel to return to dipped beam.

Note: If dipped beam is switched OFF, with main beam still activated both dipped and main beam will be extinguished. Both dipped and main beam will illuminate if dipped is turned on again.

Autolamps – A light sensor control, mounted on the front of the fascia, monitors exterior light levels and automatically switches the sidelights and dipped headlights ON or OFF.

The ignition switch must be in position 'II' for full automatic light operation.

When light fades towards dusk, the sidelights and headlights will switch ON automatically.

At dawn, as light increases, the sidelights and headlights switch OFF automatically.

Do not cover the sensor and keep the windscreen clean. Obstructing the light in this area of the sensor may lead to unwanted operation of the sidelights and headlights.

Note: If the windscreen wipers are switched on in slow or fast modes for more than 20 seconds then the exterior lights will be switched on, if selected to autolamps mode. The lights will switch off 2 minutes after the wipers are switched off or will go off straight away if auto lamps is deselected or the ignition is turned off.

Exit delay

When parking the car at night, if the headlights were switched on then they will remain on for a short period after the key has been removed from the ignition switch. This is to give a clearly lit area for occupants leaving the vehicle.

If the light switch rotary collar is in the auto position there will be no exit delay and the headlamps will turn off when the light switch is turned off.

Three settings on the rotary collar set the time that the lights will remain on after the key is removed from the ignition switch:

- 10 seconds.
- 30 seconds.
- 2 minutes.

Note: The key must not be in the ignition switch for this feature to operate.

The main beam lights can be turned off before the set delay by pressing the headlight convenience button on the key transmitter or by turning the ignition to position 'II'.

Daylight running lights

In certain countries it is a legal requirement for the lights to be on during the hours of daylight.

With the rotary collar in the OFF position, dipped headlights, sidelights, tail, number plate lights and, where fitted, side marker lights will switch on automatically with the following conditions:

- The ignition is turned to position 'II'.
- The vehicle gear selector out of park (automatic transmission only).
- The parkbrake is not applied (released).

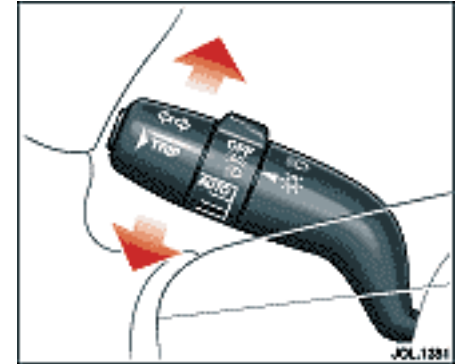

Direction indicators

The direction indicators operate when the ignition is in position 'II'.

The left column stalk has two positions for indicating left or right turn.

The first position, moving the stalk up or down, causes the indicator to flash while it is held in this position. On releasing the stalk the indicators stop flashing.

The second position is a full movement of the stalk up or down to indicate for a right or left turn, which can then be released. The indicators will remain flashing and will cancel when the turn is completed.

4-28 On the road

An audible ticking and a flashing green arrow on the instrument cluster indicates that the selected direction indicator is ON.

Note: Should a direction indicator bulb fail, the corresponding side green warning light will flash at twice the normal rate. The audible ticking will sound at twice the normal rate.

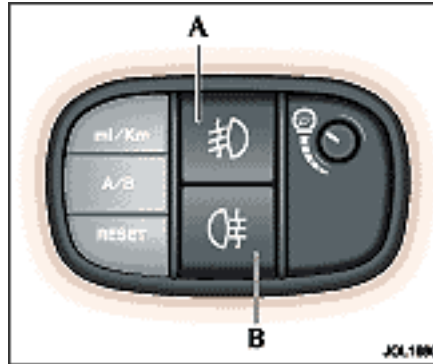

Front fog lights (A)

With the left column stalk switch in sidelight or dip position, press the switch (A) to turn on the front fog lights. Pushing the switch again will turn off the front fog lights.

Note: The front fog lights should only be used when visibility is severely restricted by fog.

Rear fog lights (B)

The rear fog lights can only be switched on if the dipped headlights are on or if the side lights and front fog lights are switched on.

Press the switch (B) to turn on the rear fog lights. Pushing the switch again will turn off the rear fog lights.

Auto headlight levelling

Automatic levelling of the High Intensity Discharge (HID) headlights is a feature which avoids dazzling oncoming drivers. A control unit adjusts the height of the lights during acceleration, deceleration and terrain variation.



Dimmer switch

The instruments, switch packs, in-car entertainment panel and the climate control panel will be lit when the exterior lights are switched on.

Push and release the knob to extend it for ease of operation.

Rotate the knob to adjust the illumination to the required level.

Push the knob again to place it in the stowed position.

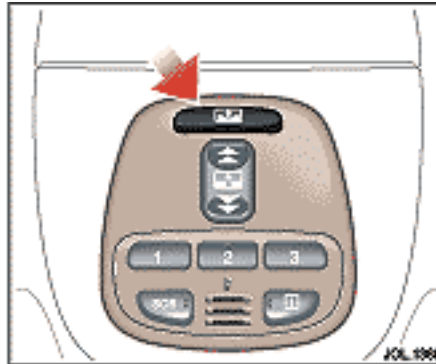

Rear sun blind

The electrically operated rear sunblind is fitted to the parcel shelf.

Push the switch to raise the sunblind.

To lower the sunblind, push the switch again.

4-30 On the road



Hazard warning

The switch is in the centre console below the radio and operates with the ignition ON or OFF. Use only in an emergency to warn traffic of a vehicle breakdown or approaching danger.

To operate: Press the switch; the direction indicators, the instrument cluster green indicators and audible warning will operate in unison. The switch symbol will light up.

To cancel: Press the switch again.

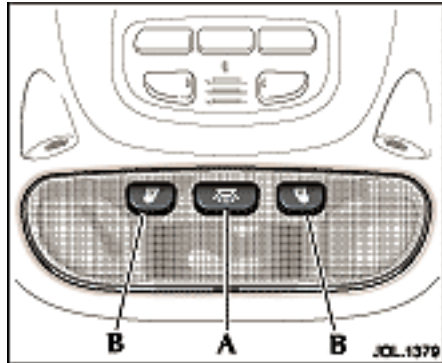

Interior lighting

Interior lighting comprises, front overhead courtesy lights, two front and rear reading/map lights, and front door puddle lights. Vanity mirrors, glove compartment, footwell and luggage compartment lights are also provided.

Press the centre switch (A) in the front roof console to turn the front courtesy lamps on. A second press turns the lamps off. The courtesy lights also operate to light the vehicle interior when a door is opened.

Reading/map lighting

The reading/map lights are turned on and off by individual switches (B).

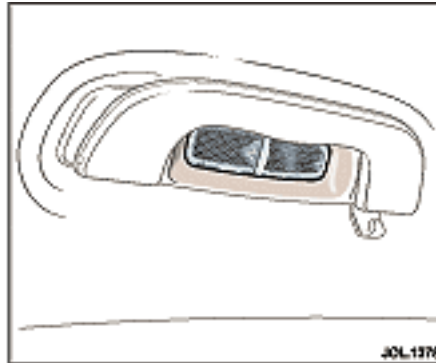

Rear lighting

The rear interior lights can be switched on or off by pressing the lens cover.

Illuminated entry/exit

When the vehicle is unlocked the courtesy lights will gradually illuminate and remain on for 20 seconds.

If the courtesy lights are on they will fade off 20 seconds after the last door is closed, or when the vehicle is locked.

Door guard/puddle lamps

Door guard lamps are fitted to each front door to give warning of an open door to passing vehicles. The puddle lamps illuminate the 'step out' area at night.

Luggage compartment lighting

The luggage compartment will be illuminated when the lid is opened.

Glove compartment

The glove compartment will be illuminated when the lid is opened.

Battery saver

If the interior lights are switched on using the centre switch in the overhead console and the ignition switch is turned to position '0', the lights will automatically turn OFF after 40 minutes.

If the interior lights are switched on by a opening a door and the ignition switch is in position '0', the lights will automatically turn off after 10 minutes.

If the glove compartment or vanity lights are switched on and the ignition switch is turned to positions '0' or 'I' or the key is removed, the lights will automatically turn OFF after 40 minutes.

4-32 On the road

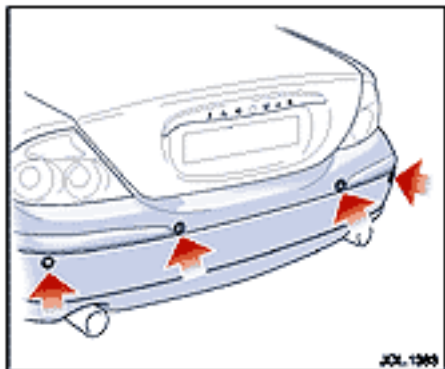

Reverse park control

Caution: It remains the driver's responsibility to detect obstacles and estimate the car's distance from them. Some overhanging objects, barriers, thin obstructions or painted surfaces which could possibly cause damage to the vehicle may not be detected by the system. Always be vigilant when reversing.

This parking aid, when reverse gear is selected and ignition on, automatically provides an audible proximity warning when reversing the vehicle. If an object is detected, a beep tone will be heard, which increases in rate as the vehicle approaches the object.

At approximately 8 inches (200 mm) the beep will become continuous for three seconds and is then automatically turned off.

Reverse park control is automatically switched off if a trailer is attached to the vehicle.

If the system has a fault when engaging reverse gear then a single, three second tone only will be heard.

Note:

1. For reliable operation, the four sensors in the rear bumper should be kept free from ice and grime.
2. When using a high pressure spray the sensors should only be sprayed briefly and not from a distance of less than 8 inches (200 mm).

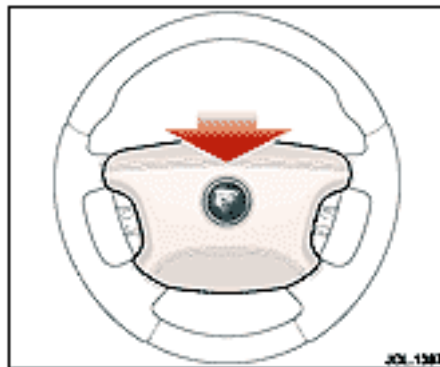

Horn

The dual tone horn is operated by pressing the centre pad on the steering wheel.

The horn also operates as a warning horn if the vehicle alarm system is activated.

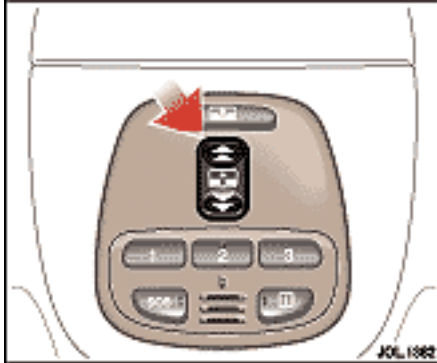

Sunroof



WARNING:

1. Before opening or closing the sunroof check that all occupants are clear.
2. When leaving the vehicle take the ignition key to prevent misuse of the sunroof switch by remaining occupants, especially children.

The sunroof switch is located in the overhead console. The ignition switch must be in either position 'I' or 'II' for the sunroof to operate.

The sunroof has a 'one-touch' facility enabling the occupant to fully open or close the sunroof in one quick movement.

To open the sunroof

- Push the rear of the switch gently upwards to the first position and hold until the sunroof is fully open. The sunroof can be stopped at any open position by releasing the switch.
- To fully open the sunroof with one touch operation, briefly push the rear of the switch fully upwards to the second position and then release. To stop the sunroof opening, briefly press the switch upwards, forwards or rearwards.

To close the sunroof

- Push the front of the switch upwards to the first position and hold until the sunroof is closed. It can be stopped at any position by releasing the switch.
- To close the sunroof with one touch operation, briefly push the front of the switch upwards to the second position and then release. To stop the sunroof closing, press the switch upwards, forwards or rearwards.

To tilt the sunroof open

- Push the front of the switch upwards and hold until the required position is reached, or until the tilt is fully open, and then release the switch.

To tilt open with one touch operation

- Briefly push the switch upwards to the second position.

To close the tilted sunroof

- Push and hold the rear of the switch until the sunroof is closed. Briefly push the rear of the switch upwards to the second position to tilt closed with one touch operation.

Sunshade operation

The sunshade can be manually opened and closed using the pull cup.

When the sunroof is fully open the sunshade is also fully open and, because the pull cup is hidden, it cannot be manually closed from this position. The sunroof will need to be fully closed to gain access to the pull cup.

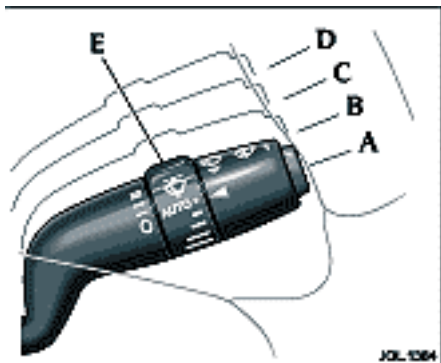

Wipers and washers

The windscreen wipers and screen wash functions are controlled by the right-hand column stalk switch and only operate with the ignition in position 'II'.

Windscreen wipers

The stalk functions are as follows:

Position (A):

The windscreen wipers are Off and parked.

First position (B):

Intermittent wipe.

Second position (C):

Slow wiper operation.

Third position (D):

High speed wiper operation.

Intermittent wipe

When intermittent wipe is selected the delay between wipes can be varied.

Turn the collar (E) to vary the delay from 3 seconds to 18 seconds.

Flick wipe

Pull the column switch towards the steering wheel for a single wipe. Holding the column switch in this position will operate the wiper continuously at slow speed until released.

Rain sensitive wiper control

When AUTO, (turn the rotary collar [E] to AUTO) and intermittent wipe is selected, the wipers will automatically operate to clear the windscreen when rain falls on to the windscreen, or when moisture is present.

For the wipers to operate, the ignition switch must be in position 'II'.

Note: When starting a journey with a wet windscreen, the rain sensing wipers will not operate immediately the ignition is switched on, therefore, a flick wipe should be used to clear the windscreen of any moisture.

Caution: Ensure that AUTO is not selected when entering a car wash or damage to the wiper blades/arms can occur.

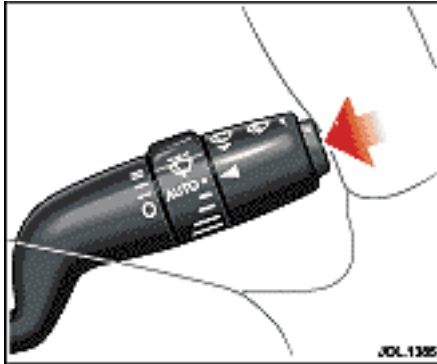

Windscreen wash/wipe

Push the button on the end of the switch to obtain the wash/wipe programme.

If the wipers are selected off or intermittent, the washers will operate at slow speed during the washing action when the button is pressed. When the button is released, the wipers will complete up to three further wipes.

If rain sensitive wipers are fitted and selected then the wipers will operate until no moisture is detected.

Headlight powerwash

Note: The headlight powerwash units are mounted between the front headlights.

The headlight powerwash feature will operate if the ignition is in position 'II' and dipped beam headlights are switched ON. It will not operate if the washer fluid level is low.

When the windscreen wash/wipe button is pressed, the headlight powerwash directs a short burst at the headlights. If the wash/wipe button is held, the headlamp wash cycle will continue for up to 20 seconds.

The headlight powerwash will operate the first time the wash/wipe button is pressed and thereafter every sixth succeeding wash/wipe operation. If the headlights or ignition are switched OFF and ON again, headlight powerwash will operate on the next press of the wash/wipe button.

Note: If the washer fluid level is low in the reservoir the windscreen wipers will not operate when windscreen wash is selected even though there may be washer fluid remaining in the reservoir and sprayed onto the screen. This is to prevent damage to the blades, or scratching of the glass, or smearing dirt across the screen. Flick wipe can be selected to clear the sprayed fluid from the screen.

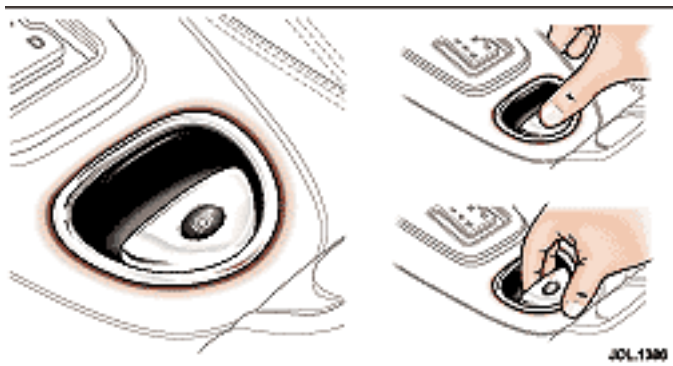

Parkbrake

The switch which operates the parkbrake is mounted on the centre console to the rear of the gear selector.

To engage the parkbrake, pull the parkbrake switch upwards and release. The switch will return to the neutral position. The parkbrake warning/brake fluid low warning light on the instrument cluster will illuminate.

To disengage the parkbrake, with the ignition switch in position 'II' or with the engine running, apply the footbrake and press the parkbrake switch down.

With automatic transmission, the parkbrake is automatically released when the gear selector is moved from park 'P' position.

Inadvertent operation of the parkbrake whilst the vehicle is in motion will cause the message 'PARKBRAKE ON' to be displayed on the message centre, the warning lamp in the instrument cluster will be illuminated and a warning chime will sound.

If the parkbrake is applied whilst the vehicle is moving, push the switch down to release it. If the switch is in the neutral position after parkbrake application, depressing the accelerator pedal will release the parkbrake.

Note: If the vehicle is in motion, the parkbrake should only be used as an emergency brake.

The parkbrake is automatically applied when the key is removed from the ignition switch. If you wish to keep the parkbrake off, press and hold the parkbrake switch down and, at the same time, remove the key.

Caution: Take care that the vehicle is safely parked to prevent it from rolling if you wish to leave the parkbrake off.

The warning lamp in the instrument cluster will remain on for a short time if the parkbrake is applied when the key is turned to position '0' or if the key is removed.

If the battery has been discharged or disconnected a message 'APPLY PARKBRAKE' will be displayed when the ignition is next switched on. Depress the foot brake and pull the parkbrake switch up to apply the parkbrake. This is required to reset the parkbrake system. The parkbrake will now function correctly.

Interior features

The centre console carries the cup holders, the cubby box and armrest and (where fitted) the phone.



WARNING:

1. Do not place hot drinks in the cup holders whilst the vehicle is moving, there is a risk of scalding.
2. Use soft cups only.

The sliding armrest is hinged at the rear and has a release button located on the front of the armrest. The chromed button is pulled upwards to raise the armrest and gain access to the cubby box or (when fitted) the telephone. As the armrest is lifted it slides back under its own weight allowing full access to the cubby box.

To slide the armrest to expose the two cupholders (when fitted), pull the button upwards and slide the armrest rearwards.

Where fitted, an electrical accessory socket is located inside the cubby box. This 12 volt socket should only be used for the temporary connection of electrical items, such as a vacuum cleaner, cool box or to charge the telephone battery. The cigar lighter is designed to be used just to heat the lighter element and not for providing a power source for accessories.

Rear centre armrest

Pull the loop on the rear centre armrest to lower. If not required, raise the armrest to its upright position and push firmly into place. Ensure that the armrest is raised when lowering the seat back to increase the luggage compartment area.

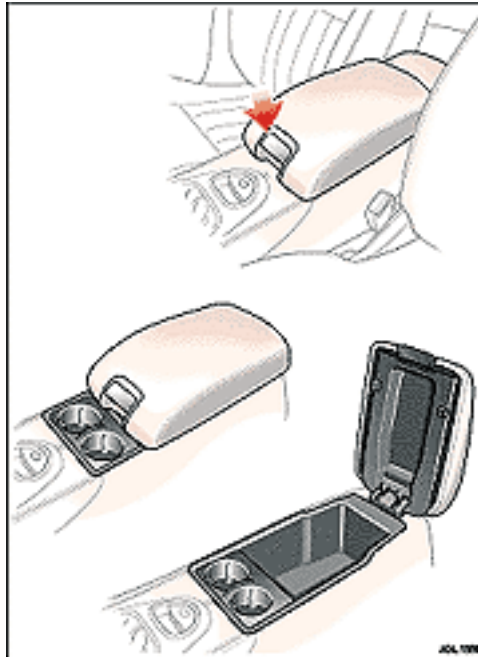

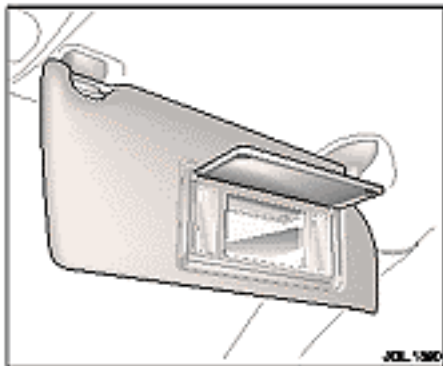

Sun visors and vanity mirrors

Adjustable sun visors can be swung downwards or unclipped and swung sideways to reduce sun glare.

The sun visors are fitted with illuminated vanity mirrors, behind a hinged flap. The light comes on when the flap is lifted.

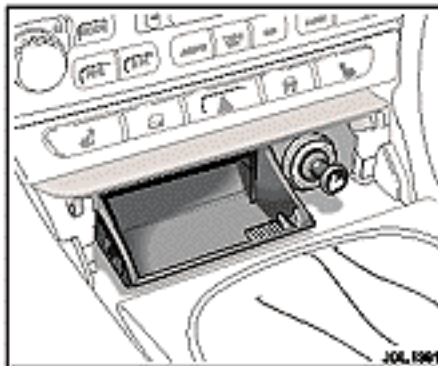

Cigar lighter and ashtray

Push the lid to gain access to the cigar lighter and ashtray. To operate the cigar lighter the ignition must be on, press the lighter in and wait until the element has heated, it will then pop-up.

Note: Never hold the lighter knob down. Do not attempt to remove particles from the heating element as it is self-cleaning. The cigar lighter is designed to be used just to heat the lighter element and not for providing a power source for accessories.

To empty the ashtray, lift it out vertically and remove. After emptying, push the ashtray into the opening until it snaps back into place.

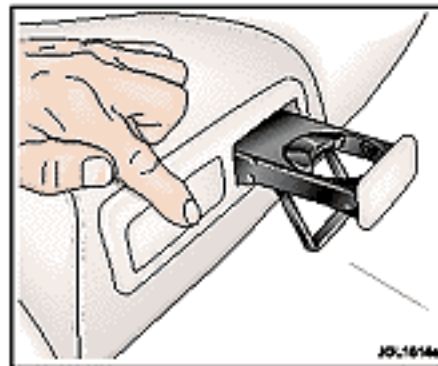

Rear cup holders

Cup holders for rear seat passengers can be accessed by pushing a tray front to release it from the seat. Push the cupholder back into the seat when no longer required.



WARNING:
Never have hot liquids in the cup holder whilst the vehicle is moving. If the contents spill, occupants could be scalded. Use only soft cups and cool liquids.



Glove compartment

A glove compartment is located below the passenger's airbag.

To open the glove compartment, lift the handle and allow the lid to drop down. The compartment will be illuminated when open.

If the compartment is left open the lamp will extinguish approximately 40 minutes after the ignition has been set to position '0'.

The glove compartment can be locked using an ignition key.

Starting/stopping the vehicle

Automatic transmission

When the vehicle is stationary the automatic gear selector may be left in 'D', '2', '3', '4' or '5', unless the vehicle is to be parked. When stopping for traffic lights, junctions etc., either select 'P' or apply the parkbrake and select 'N'.

Manual transmission

When the vehicle is stationary it is advisable to apply the parkbrake and to move the gear selector to the Neutral position.

Before starting

Before starting the engine, new owners/drivers should familiarize themselves with the layout and operation of the controls and instruments.



WARNING:

Before attempting to start the engine, check parkbrake is ON and gear selector lever (automatic transmission) is in position 'P' or 'N' or (manual transmission) in Neutral.

To start the engine

The engine cannot be started until the automatic transmission gear selector is in 'N' or 'P', and, vehicles with manual transmission, the clutch pedal must be depressed.

Insert the key into the ignition switch and turn clockwise to position 'II' to switch on the ignition.

When the key is turned to position 'III' the starter motor will turn the engine until:

- The key is released and automatically returns to position 'II'.
- The ignition switch is turned to '0' or 'I'.
- The gear selector is moved out of 'P' or 'N' (automatic transmission vehicles).
- The engine starts.

If the engine fails to start the key must be turned to position '0' before attempting to restart.

Do not use the starter continuously for longer than six seconds. Continued use of the starter will discharge the battery and may damage the starter mechanism.

When the engine starts, release the key. Wait until the engine stops turning before re-using the starter.

The red charge warning light in the instrument cluster should go out when the engine is running.

If the engine fails to start

If an ignition key is placed in the ignition switch and turned to position 'II' and the alarm security light is flashing, it is possible that the engine will not start. In any event, please contact a Jaguar Dealer to investigate the cause of the light flashing.

With manual transmission vehicles, the clutch pedal has not been fully depressed.

It is possible that the fuel system inertia switch may have tripped, see Section 6 for the resetting procedure.

If the engine persistently fails to start and flooding is suspected, depress the accelerator pedal fully, hold it in this position and turn the key to position 'III' for six seconds. Release the key, remove your foot from the accelerator pedal and then attempt to restart the engine.

Note: The engine cannot start whilst the pedal is fully depressed, it must be released to enable the engine to start.

If the engine still fails to start, switch the ignition OFF and contact a Jaguar Dealer.

To stop the engine and lock the steering

Turn the key from position 'II' to the 'lock' position 'O'. This turns off the ignition and stops the engine. The steering will be locked when the key is removed from the switch.

Leaving the key in position 'I' or 'II' will discharge the battery.

Parking the vehicle

When leaving the vehicle, remember the following:

- Whenever the vehicle is being parked, apply the parkbrake and, with automatic transmission, move the gear selector to Park 'P'.
- Do not leave children or pets in the vehicle unattended.
- Do not leave luggage or valuables on view. Always take your valuables with you or lock them in the luggage compartment.
- Remove the ignition key and spare keys, even when the vehicle is in your garage.
- When the vehicle is unoccupied, close all windows and lock all doors securely.

- Park the vehicle where it can be seen. At night, park in a well-lit area.
- When leaving the vehicle unattended, for maximum security ensure that the doors are double-locked (where fitted).

Ensure that the keys and the key transmitters are removed from the vehicle before locking the doors, and that all doors, the trunk and the hood are closed.

4-42 On the road

Automatic transmission

The 'J'-gate gear selector lever is designed to accommodate two different driving techniques as follows:

- Automatic selection – The right-hand side of the selector gate.
- Manual selection – The left-hand side of the selector gate to individually select 5th, 4th, 3rd, or 2nd gear.

Gearshift interlock

(automatic transmission only)

A brake pedal/gearshift interlock system is incorporated in the automatic gear selector mechanism.

To move the gear selector from Park:

1. Turn the ignition key to position 'II' or start the engine.
2. Press the brake pedal.

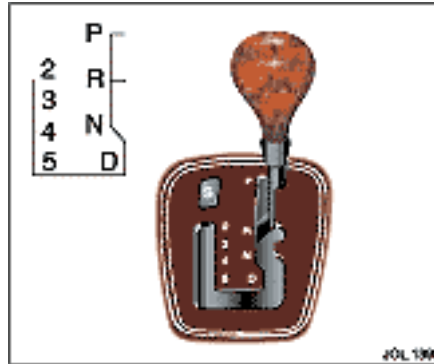

Gear selector positions



WARNING:
The parkbrake or brake pedal must be applied before selecting forward or reverse drive from a stationary position.

P = Park – Use when parking. In this position the transmission is locked. Do not select if the vehicle is moving.

N = Neutral – Disconnects the driveline from the engine. Use the parkbrake when stopping temporarily.

R = Reverse – Do not select if the vehicle is moving forward.

The reversing lights come ON automatically when reverse gear is selected and the ignition switch is in position 'II'.

D = Drive – All six gears are changed automatically as required by the throttle position and road speed.

2, 3, 4, 5 = Second, third, fourth, fifth – If selected, the transmission operates automatically but will not engage gears higher than the one selected.

Note:

1. After selecting forward or reverse drive ranges from Neutral or Park, wait briefly for the transmission to engage before accelerating.
2. When in Neutral or Park the engine can only be accelerated to 3000 rev/min automatic transmission or 6000 rev/min manual transmission.

Drive to fifth

When driving in gear position 'D' with sixth gear engaged, the gear selector can be shifted sideways across the gate to '5'. Provided that the vehicle's speed is not too great, the transmission will shift down to fifth. Sixth gear will be inhibited until the gear selector is moved back to 'D'.

Hill climbing and engine braking

When driving on roads with long downhill gradients, selecting '3' or '2' (depending on road/traffic conditions) will give engine braking.

When the gear selector is moved from 'D', '5', '4' or '3' down to '2', downshift to second gear will only take place at road speeds below 40 mph (64 km/h).

Shift inhibit

Reverse is inhibited when the vehicle is moving forward at speeds above 5 mph (8 km/h).

Note: Reverse inhibit will not function in limp home mode.

Kickdown

Kickdown is operated when the pedal is pressed fully down to provide maximum engine performance. Kickdown is used in circumstances where rapid acceleration is required, such as when overtaking.

Kickdown causes the transmission to change down to the lowest gear possible to achieve maximum acceleration.

The gear engaged depends on the road speed at the time of kickdown.

As well as shifting down, the gear shift points are extended to give greater performance. This mode is in effect for as long as the pedal is pressed fully down.

Limp Home Mode

In the unlikely event of an electrical or mechanical failure, transmission operation will be impaired. The vehicle gear selector ranges P, R, N, D can still used to enable the vehicle to be driven to a safe area.

The driver should be aware that the vehicle's performance will be reduced and must take this into account when driving. In this event consult a Jaguar Dealer **immediately**.

4-44 On the road

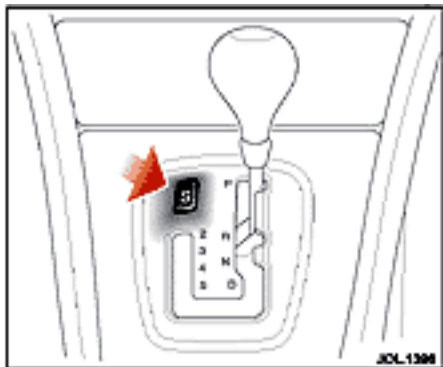

Sport mode

The switch marked 'S' on the 'J'-gate surround enables the driver to select either normal 'N' or sport 'S' modes.

When sport mode is selected the automatic transmission will operate normally, but the gear shift points are extended to make full use of the engine's power reserves.

To select 'Sport', press the switch. A red light within the switch is illuminated to indicate that sport mode has been selected.

To cancel 'Sport', press the switch again.

Note: Both sides of the 'J'-gate can be used irrespective of the transmission mode, e.g. with 'S' selected the transmission can be operated in full automatic or by manual selection.

In addition to the 'switched' transmission modes ('N' and 'S') the transmission control module will select shift patterns to suit specific conditions.

Cruise Control – When cruise control is operating at set speed the transmission selects a shift pattern to suit cruise control operation.

DSC/Traction control – When DSC/traction control is switched ON and the system is activated, the transmission selects a shift pattern to suit traction control conditions.

Gradients – When the vehicle is being driven on roads with uphill gradients, the transmission adapts the shift pattern to make better use of engine power and aid engine cooling.

Note: Under the conditions described above, the relevant transmission mode will override the 'N' or 'S' modes selected by the driver. When such conditions no longer exist, e.g. Cruise Control switched OFF, the transmission will revert to the shift pattern previously selected by the driver, i.e. 'N' or 'S'.

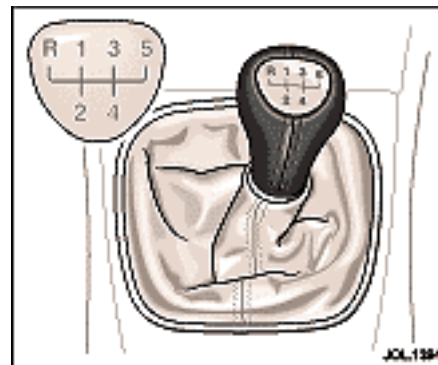

Manual transmission

Gear selector lever

A diagram of the gear shift pattern is set in the top of the lever knob.

Depress the clutch pedal completely when changing gear. To avoid excessive clutch wear do not drive with your foot resting on the clutch pedal.

To select reverse gear, move the gear lever fully to the left-hand side of the gate, against spring pressure, and push it forwards.

Caution: Do not select reverse gear while the vehicle is moving forwards.

Anti-lock braking system (ABS)

This system helps to prevent the road wheels from locking and skidding during emergency braking, assisting the driver to maintain full steering and directional stability.

The factor controlling ultimate stopping distance and cornering ability is tyre/road adhesion.



WARNING:

- 1. It remains the driver's responsibility to drive safely according to prevailing conditions.**
- 2. The fact that a vehicle is fitted with ABS must never allow the driver to be tempted into taking risks which could affect his/her safety or that of other road users.**
- 3. The addition of ABS cannot overcome the consequences of trying to stop in too short a distance, cornering at too high a speed, or the risk of aquaplaning.**

- 4. The driver should always take road conditions into account. A slippery road surface always requires more braking distance for a given speed, even with ABS. A possible increase in stopping distance compared to locked wheels may occur during ABS operation on slushy snow, gravel, sand, or some heavily corrugated or ridged warning sections of road surfaces.**

ABS optimises tyre/road adhesion under maximum braking conditions though it cannot provide increased cornering ability. There is no need for special braking techniques, such as 'pumping' the brakes, to achieve optimum braking distances and control on poor or slippery road surfaces. Tyres must be in good condition to achieve maximum adhesion.

During normal braking the ABS will not be activated. However, if the braking force applied begins to exceed tyre/road adhesion the ABS will automatically activate, preventing the road wheels from locking.

In these circumstances a pulsating effect will be felt from the brake pedal indicating that the system is functioning. The pulsating effect is due to small fluctuations in pressure supplied to the brakes by the system to maintain full tyre/road adhesion.

Under severe braking on some road surfaces tyre noise may be apparent even though the wheels will at no time become locked.

ABS monitoring

The ABS control module monitors the ABS electrical system from ignition switch ON to ignition switch OFF.

Any malfunction will be indicated by the anti-lock warning light coming on.

Should a fault develop in the ABS system, the brake system will still operate conventionally and with the same standard of performance as vehicles not equipped with ABS.

Caution: Consult a Jaguar Dealer immediately if the warning light comes on while driving, a system failure is indicated.

Advice on ABS braking techniques

For optimum ABS performance the instructions on braking techniques during ABS operation should be followed:

1. Do not release brake pressure when the pulsating effect is felt. Maintain a constant pressure until the manoeuvre is completed.
2. To familiarise yourself with the feel of the brake pedal during ABS braking, practise an emergency stop procedure, always making sure it is safe to do so. With the seat belts fitted to all occupants, drive the vehicle at 20 mph (32 km/h) and brake sharply.
3. ABS enables the driver to steer around obstacles during emergency braking. However, the consequences of turning sharply at high speed cannot be overcome by the ABS.
4. Do not attempt to 'pump' the brakes to avoid skidding as this can interfere with the ABS operation. The ABS will not allow the wheels to skid under normal road conditions.
5. The ABS will tend to keep the vehicle straight during braking. Because braking distances may increase under certain road conditions, it is necessary to plan and make turning manoeuvres as early as possible.

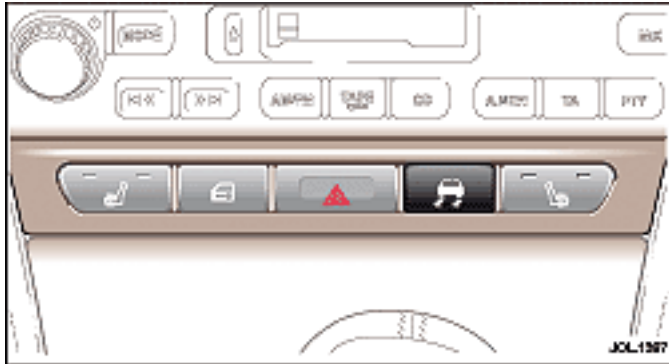

Traction control

The traction control system will intervene to prevent wheel spin, by automatically reducing the power output from the engine and applying braking to individual wheels.

This improves acceleration, particularly on surfaces with uneven friction, for example, one wheel on ice the other on tarmac.

Traction control is always switched ON when the engine is started.

If the system is operating, the warning light in the instrument cluster will flash.

The traction control (and dynamic stability control, when fitted) system can be switched OFF by pressing the switch on centre console switchpack. The warning light in the instrument cluster will remain on, and a message will be shown to indicate that the system has been switched OFF. If the switch is pressed again the system will switch ON.

Note: If cruise control is engaged it will automatically disengage if traction control activates.

A system malfunction is indicated by a message. It is safe to drive the vehicle but the system may not activate under wheel spin conditions. Report the fault to a Jaguar Dealer as soon as possible.

Message: **TRACTION CONTROL FAULT**

Warning light: **Amber**

and the instrument cluster warning light will be lit.



WARNING:

- The fact that the vehicle is fitted with Traction Control must never allow the driver to be tempted into taking risks which could affect his/her safety or that of other road users. In all cases it remains the driver's responsibility to drive safely according to the prevailing conditions.**
- It is recommended that, if using snow chains, traction control should be switched OFF.**

DSC/Traction control – When DSC/traction control is switched ON and the system is activated, the transmission selects a shift pattern to suit traction control conditions.

4-48 On the road

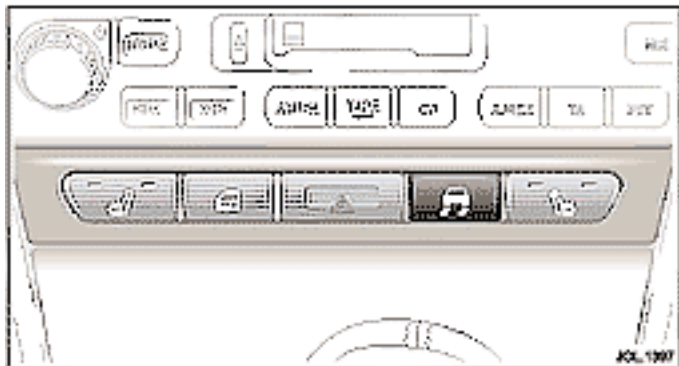

Dynamic stability control (DSC)

Dynamic Stability Control is operational whenever the engine is running, unless it has been switched off. If the system is operating, the warning light in the instrument cluster will flash.

The DSC system controls the anti-lock braking system (ABS), traction control and yaw control of the vehicle.

Yaw control determines the vehicle's direction relative to the driver's inputs (sideslip and under/oversteer). It applies braking pressure to individual wheels if excessive variation is detected. This ensures that the vehicle follows the driver's intended direction of travel.

The system will intervene to prevent wheel spin, by automatically reducing the power output from the engine and applying braking to individual wheels.

This improves acceleration, particularly on surfaces with uneven friction, for example, one wheel on ice the other on tarmac.

The dynamic stability control system can be switched OFF by pressing the switch on the centre console switchpack. The warning light in the instrument cluster will remain on, and a message will be shown to indicate that the system has been switched OFF. If the switch is pressed again the system will switch ON.

Note: If cruise control is engaged it will automatically disengage if stability control activates.

If a message centre is fitted, a system malfunction is indicated by the message:

DSC NOT AVAILABLE

Warning light: **Amber.**

For all vehicles, the instrument cluster warning light will be lit.

It is safe to drive the vehicle but the system may not activate under wheel spin or slide conditions. Report the fault to a Jaguar Dealer as soon as possible.



WARNING:

- 1. The fact that the vehicle is fitted with Dynamic Stability Control must never allow the driver to be tempted into taking risks which could affect his/her safety or that of other road users. In all cases it remains the driver's responsibility to drive safely according to the prevailing conditions.**
- 2. It is recommended that when using snow chains, DSC should be switched OFF.**

General driving information



WARNING:

Ensure the parkbrake is on and the automatic gear selector is in position 'P' or 'N' before attempting to start the engine.

Before driving off, check the gauges and warning lights and messages. Take special note of any warning light that is on.

Seat belts are provided for your safety and it is unwise, and in certain countries illegal, to commence any journey, however short, without wearing them.

Warming up

Do not operate the engine at high speed when first started but allow time for the engine to warm up and the oil to circulate.

Engine braking on downhill gradients

When driving on mountain roads with long downhill gradients it is advisable to select a low gear.

Running-in

Apart from a few precautionary recommendations, there are no strict 'running-in' procedures for this vehicle.

By observing the following advisory notes you will ensure maximum engine, transmission and brake life for your vehicle:

1. Allow the engine to warm up thoroughly before operating at engine speeds over 3500 rev/min.
2. Vary the speed frequently.
3. From 940 miles (1500 kilometres) onwards, gradually increase performance of the vehicle up to the permitted maximum speed, where road conditions permit.

Running-in for brakes

To ensure that the brake pads can 'bed-in' evenly and reach their optimum wear and performance condition, usually within 300 miles (480 kilometres), the following points are recommended:

1. Where possible, avoid heavy braking or rough usage of the brakes as this can result in damage being caused to the brake pads and discs.
2. Avoid prolonged use of the brakes, for example, when descending severe gradients.
3. Frequent light application of the brakes is desirable. This helps to fully 'bed-in' the brake pads before the normal running-in period is completed and the vehicle is operated at high speeds, when maximum brake efficiency will be required.

The above equally applies when new discs or pads have been fitted.

4-50 On the road

Use of headlamps in daylight

When visibility is poor the headlamps with dipped beam setting should be switched on so that the vehicle may be seen more easily by other road users. The instrument illumination dimmer control adjusts the brightness of the panel lighting.

Engine oil consumption

A certain amount of oil consumption is normal. The rate of consumption will depend on the following:

- The quality and viscosity of the oil.
- The amount of oxidation and dilution of the oil.
- Climatic conditions.
- The speed at which the engine is being operated.
- Road conditions.

Drivers should expect above normal consumption when the engine is new, and after running-in if high speeds are sustained.

Winter driving

Freeing a frozen door lock

Caution: Do not apply a proprietary lock de-icer through the keyhole.

Should the lock become frozen, warm the end of the key before use.

Windscreen wiper blades

Before driving away, clear any ice from the windscreen and check that the wiper blades are free. Switching on the heated screen will accelerate this process. The heated wiper park, if fitted, will come on automatically.

Frost precautions

The correct concentration of coolant must be maintained at all times when 'replenishing' or 'refilling' the cooling system.

Touring

Foreign travel

Before planning foreign travel, check with a motoring organisation to ensure that your vehicle will comply with legal requirements of the countries you intend to visit.

It is advisable to carry vital spare parts to ensure against a breakdown in a remote area.

International motoring organisations are helpful for all aspects of long distance touring advice.

In some countries it is a legal requirement to carry spare vehicle bulbs.

First aid kit

A first aid kit is compulsory equipment in certain countries. Your Jaguar Dealer can supply a first aid kit.

Fire extinguishers

Many countries make it compulsory to carry a fire extinguisher. Your Jaguar Dealer can supply and fit one.

Petroleum spirit in containers

Some countries forbid the carrying of petrol in containers, as do most ferry and hovercraft operators.

Cellular radio telephones

Ask your motoring organisation about the use of cellular radio telephones before travelling abroad, as some countries exercise controls on the importation and use of such equipment.

Roof-rack

Only the Jaguar approved roof-rack should be used.

The maximum load, including the weight of the rack, must not exceed the load rating indicated on the roof rack bars and **must** be deducted from the vehicle maximum luggage load.

Loads on the roof-rack may affect vehicle handling, especially in crosswinds or when cornering.

Jaguar warning triangle

A warning triangle to give traffic advanced notice of a disabled vehicle is compulsory in many countries. A triangle, designed to international standards is standard equipment in certain countries.

Hazard warning lights must be used with the warning triangle.

The warning triangle with its stand legs folded flat, is mounted on the inside of the luggage compartment lid.

In an emergency, remove the triangle and unfold its stand legs. Place the triangle in the road in accordance with local traffic regulations to give oncoming traffic warning of an immobilised vehicle.

4-52 On the road

Towing a caravan or trailer

Your Jaguar Dealer, and the main motoring and caravanning organisations can advise you on towing, towing weight capacities and about regulations that apply in other countries.

The following are important points of safety, stability and comfort upon which further advice should be sought:

- Maximum braked towing weight is permissible, provided long periods of uphill driving on gradients over 8% are not undertaken.
- In high altitude mountainous regions, the thinner atmosphere can reduce engine performance. Above 3250 feet (1000 metres) the stipulated maximum permitted gross train weight must be reduced by 10% for every 3250 feet (1000 metres) in altitude.
- The kerbside weight of the vehicle can be found in Section 8.
- When towing, the nose weight of the caravan or trailer and the tow-bar assembly must be deducted from the permissible maximum load (see Section 8).

- When towing at the maximum permissible rear axle load keep within legal towing speeds but in any case do not exceed 62 mph (100 km/h). Increase tyre pressures to 39 lbf/in² (270 kPa, 2.7 bar, 2.76 kg/cm²).
- The recommended maximum tow-ball nose weight is shown in Section 8. Having a lower nose weight or exceeding the maximum nose weight limit may impair the vehicle's handling.
- It is essential that only a Jaguar tow-bar and Jaguar electrical tow-bar kit are supplied and fitted by a Jaguar Dealer.
- Avoid heavy braking. As the overrun brake on the caravan or trailer is not connected to the ABS, heavy caravan or trailer braking could critically affect the stability of the outfit as a whole.
- Ensure that the towing vehicle's engine, transmission, suspension, brakes and tyres are fully efficient and regularly serviced. Similarly check the wheels, tyres, brakes and wheel bearings of the caravan or trailer.
- Adjust the headlight level to avoid dazzling other road users.

Caution:

1. **Using electrical kits not specifically designed for this Jaguar will damage the electrical system of the vehicle.**
2. **When not in use, it is recommended that the removable tow-ball is either securely stowed in the luggage compartment or, preferably, not in the vehicle. Do not leave it loose in the vehicle.**

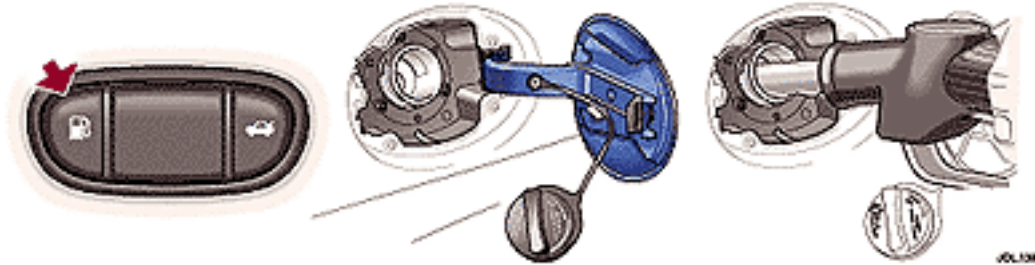

Fuel and refuelling

Before refuelling, switch off the ignition and remove the key.

Note: Do not leave the ignition key in the vehicle; vehicles have been stolen from garage service/filling stations whilst the driver is absent from the vehicle. It is recommended that the vehicle is locked, if left unattended.

Caution: No additives of any kind (fuel or oil) must be put into the fuel tank. Additives could reduce engine life or affect exhaust emissions.



WARNING:

- 1. Fuel vapour is highly flammable and in confined spaces is explosive and toxic. In the event of inadvertent spillage, and before refuelling, always switch OFF the engine. Do not use exposed flame or light. Do not smoke. Do not inhale fumes.**
- 2. Do not fill the tank so that fuel is visible in the fuel filler intake tube. This could cause spillage and danger from exposed fuel.**

Fuel tank filling

Caution: Your vehicle is fitted with catalytic converters and must only be filled with 'Unleaded Fuel'.

The fuel filler flap release switch is located in the knee bolster switchpack below the fascia. The filler flap is on the right-hand side of the vehicle.

Turn the filler cap anti-clockwise, an 1/8 turn, and remove the cap from the filler neck. The cap is held by a retaining strap and can be stowed over the hook on the flap to allow easy access to fill the tank.

A warning label on the inside of the fuel filler flap advises type/grade of fuel.

4-54 On the road

When filling, the dispenser nozzle must be inserted into the filler neck sufficiently to open the trap door for fuel to flow into the fuel tank. For quickness and to completely fill the tank, ensure that the fuel nozzle rests on the filler neck as shown. Fill the tank until the filler nozzle automatically shuts off. Filling beyond this point could result in fuel spillage.

After refuelling, twist the filler cap clockwise until it clicks and close the flap, which automatically locks shut.

The continuous use of high quality fuel makes the need for additional additives unnecessary. This will help to protect the engine components against corrosion, carbon deposit formation and prevent the fuel injection system from clogging.

If in doubt your local Jaguar Dealer will advise on which fuel must be used in your vehicle.

Emission control components

Owing to the legislative requirements or options available in some countries, a Jaguar Dealer should be consulted where any doubt exists as to the precise emission control system specification of this vehicle.

Fuel requirements

The filler neck of the fuel tank is a small diameter (except Japan) to suit the unleaded fuel pump nozzle and will prevent the larger diameter leaded fuel nozzle from entering the filler neck.

Unleaded fuel

All vehicles are fitted with a catalytic system and can only use unleaded fuel.

Unleaded fuel must be used for the emission control system to operate properly. Its use will also reduce spark plug fouling, exhaust system corrosion and engine oil deterioration.

The preferred fuel should have an octane rating of at least 95 RON (Research Octane Number).

'Super Green' Plus 98 RON unleaded fuel (where available) may be used as an alternative to the standard 95 RON unleaded fuel.

Some countries have only 91 RON fuel available. The vehicles in these countries are specially calibrated to use this fuel.

Using unleaded fuel with an octane rating lower than recommended can cause persistent, heavy 'spark knock' (a metallic rapping noise). If severe, this can lead to engine damage.

If a heavy 'spark knock' is detected even when using fuel of the recommended octane rating, or if you hear steady 'spark knock' while holding a steady speed on level roads consult a Jaguar Dealer to have the problem corrected. Failure to do so is misuse of the vehicle, for which Jaguar Cars Limited, is not responsible. However, occasional light 'spark knock' for a short time while accelerating or driving up hill, may occur.

Fuels containing alcohol

Caution: Take care not to spill fuel during refuelling. Fuel containing alcohol can cause paint damage, which may not be covered under the warranty.

Some fuel suppliers sell fuel containing alcohol without advertising its presence. Where uncertainty exists check with the service station operator.

Note: Some difficulty in starting may be encountered when using alcohol blended fuel.

Ethanol

Fuels containing up to 10 per cent ethanol (grain alcohol) may be used. Ensure the fuel has octane ratings no lower than those recommended for unleaded fuel. Most drivers will not notice any operating difference with fuel containing ethanol. If a difference is detected, the use of conventional unleaded fuel should be resumed.

Methanol

Some fuels contain methanol (methyl or wood alcohol). If you use fuels containing methanol the fuels must also contain co-solvents and corrosion inhibitors for methanol. Also, do not use fuels that contain more than three per cent methanol even if they contain co-solvents and corrosion inhibitors. Fuel system damage or vehicle performance problems resulting from the use of such fuels is not the responsibility of Jaguar Cars Limited, and may not be covered under the warranty.

Methyl Tertiary Butyl Ether (MTBE)

Unleaded fuel containing an oxygenate known as MTBE can be used provided the ratio of MTBE to conventional fuel does not exceed 15 per cent.

MTBE is an ether based compound, derived from petroleum, which has been specified by several refiners as the substance to enhance the octane rating of fuel.

Catalytic converters

A few precautions on the use of vehicles fitted with catalytic converters are necessary. These are:

1. In order to maintain the efficiency of the emission control system it is essential that unleaded fuel is used. Use of leaded fuel will seriously damage the catalytic converters.
2. Heavy impact on the converter casings must be avoided.
3. The engine settings must not be altered; they have been established to ensure that the vehicle will comply with stringent exhaust emission regulations. Incorrect engine settings could cause unusually high catalytic converter temperatures and thus result in damage to the converter and vehicle. If adjustment to the settings is considered necessary, this should be performed by a Jaguar Dealer.

4-56 On the road

Catalytic converters (continued)

4. A correctly tuned engine optimises exhaust emissions, performance and fuel economy and it is recommended that the vehicle is regularly maintained.
5. Do not continue to operate the vehicle if any engine malfunction is evident; malfunctions should be rectified immediately. For instance, misfire, loss of engine performance, excessive oil consumption or engine run-on may lead to unusually high catalytic converter temperatures and may result in damage to the converters and vehicle.
6. The use of catalytic converters increases exhaust system temperatures, therefore, do not operate or park the vehicle in areas where combustible materials such as dry grass or leaves may come into contact with the exhaust system.
7. Do not run the engine with either a spark plug lead disconnected or a spark plug removed. Do not use any device that requires an insert into a spark plug hole in order to generate air pressure e.g. tyre pump, paint spray attachment etc., as this could also result in catalytic converter damage.
8. The vehicle is designed for normal road use. Below are examples of abuse which could damage the catalytic converters and vehicle. These may lead to a dangerous condition due to excessively high catalytic converter temperatures:
 - Competition or off-road use.
 - Excessive engine speed.
 - Overloading the vehicle.
 - Switching off the engine whilst in gear.

Introduction

The cabin is supplied with filtered air from a fully automatic electronic climate control system which also provides individual selection of temperature (dual zone) by the front occupants. The system can be overridden by manual controls.

The climate control panel is located in the centre console above the radio and audio controls. There are two variants:

- A dedicated control panel with LCD (liquid crystal display) screen (see page 5-4).
- A multi-function touch control and display unit shared with navigation and other systems (see page 5-8).

The climate control system may also be operated by spoken commands if the optional voice activation system is fitted. For full information on the use of this system refer to the Voice Activation Handbook.

Recommended operation

Automatic climate control

Automatic climate control provides efficient regulation of the vehicle environment without constant adjustments from the occupant.

Sensors inside the vehicle monitor temperature, humidity and direct sunlight. In response, the electronic control system automatically adjusts the heat input, fan speed, air intake and air flow distribution so as to maintain the selected temperature(s) and reduce misting.

Automatic operation provides optimum comfort under most driving conditions.

It is recommended that automatic control (AUTO) is selected as the normal operating mode.

Use of air conditioning

Air conditioning is an integral part of the climate control system, providing cooled and dehumidified air for occupant comfort; the dry airflow is also effective in preventing misting of the windows.

While the air conditioner can be manually switched off, it is recommended that it is used in all climatic conditions throughout the year, preferably in AUTO mode.

Close all windows and the sunroof when the air conditioning is on to ensure satisfactory operation.

Use of air recirculation

The air conditioner/heater system is supplied with fresh air via an intake flap. Closing the flap causes the air inside the vehicle to be recirculated. This helps to prevent unpleasant odours from being drawn into the vehicle and also to improve the performance of the air conditioner in very hot conditions. However, the use of recirculated air will cause screen misting after a short period and should only be used as necessary.

In AUTO mode, the air intake flap is controlled automatically. If required, air recirculation may be manually selected for either a short or indefinite period.



WARNING:

To prevent humidity build up inside the vehicle and possible screen misting, avoid driving with the air conditioning system off or in manual air recirculation for prolonged periods.

5-2 Climate control

General points

To ensure the satisfactory operation of the climate control system, note the following points:

- Ensure that the external grille at the base of the windscreen, which provides fresh air for the climate control system, is kept clear of leaves, snow or obstructions.
- A solar sensor is mounted on the centre top of the fascia, as shown opposite **(A)**. Ensure that this sensor is not covered.
- Temperature and humidity sensors are located behind the small grille **(B)**. Do not cover or obstruct the opening.
- Air ducts under the front seats supply the rear passenger footwells (see illustration opposite). Objects or material placed under the seats may block or obstruct the open ducts.
- The external air intake to the air conditioner/heater system is fitted with a filter. Ensure that the filter is changed at the specified service intervals to maintain efficient operation.

- If the air conditioning system is not used frequently, it should be run briefly at least once each week, with a cold setting, to prevent the seals from drying out with subsequent refrigerant leaks.
- Moisture removed from the air by the air conditioning unit is discharged onto the road underneath the vehicle. After stopping, puddles of water may form underneath the vehicle.
- Approximately 25 minutes after the ignition is switched off, the interior fan will automatically switch on and run at full speed for 2 minutes. This action removes moisture from the air conditioner, reducing the possibility of misting and odours occurring when the system is next operated.

Air distribution

The illustration opposite shows the location of the air vents within the vehicle. The airflow from the fascia face level vents is regulated using thumbwheel controls and adjustable direction vanes.

Air distribution between the windscreen, fascia and floor levels is selected automatically when operating in AUTO mode but can be selected manually.

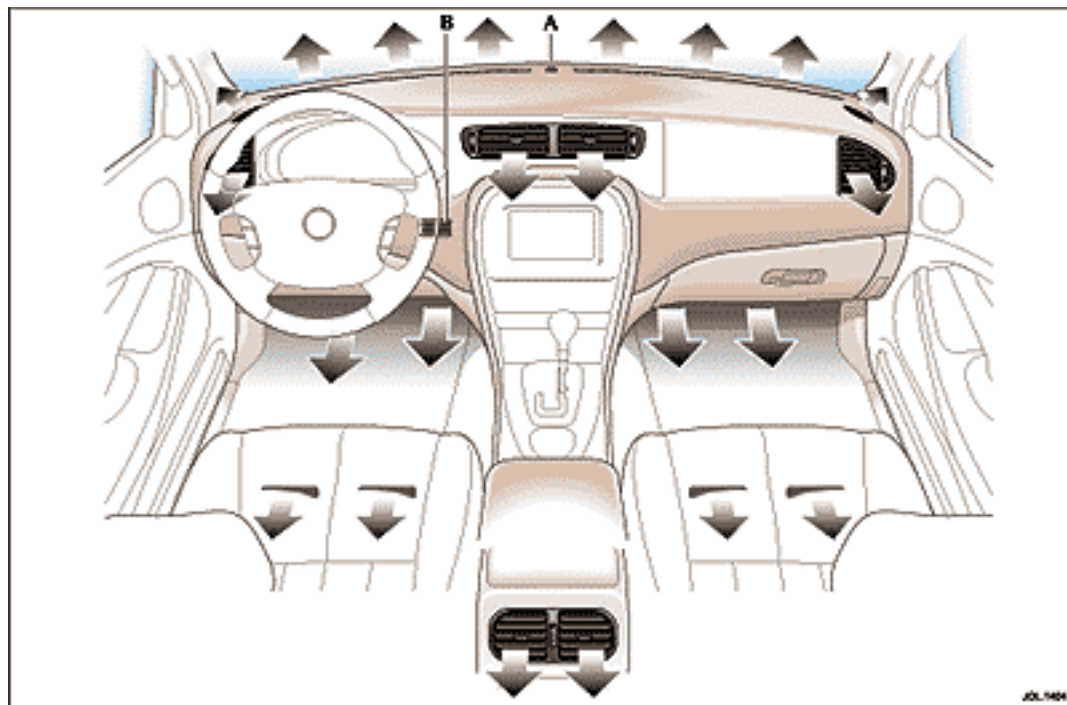

5-4 Climate control

Automatic climate control with LCD screen

The climate control functions are selected by push buttons and a rotary control. When a button is pressed, selection of the function is confirmed by a beep; most buttons also have an illuminated LED.

Many system functions also have graphic symbols displayed on the LCD (liquid crystal display) screen.

Automatic control (AUTO) may be overridden at any time. Defrost/demist operation is available and also manual selection of fan speed, air distribution, recirculation, air conditioning and windscreen heating.

Panel illumination

With the exterior lighting switched on, the graphics on the panel controls are illuminated by low level backlighting.

The illumination level is adjusted by the common instrument panel dimmer control (see Section 4).

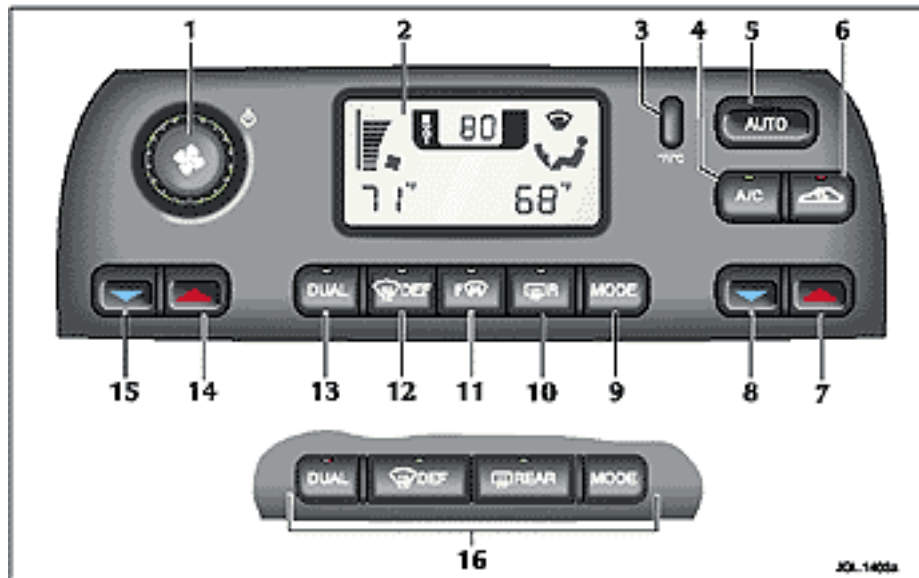

1. Fan speed and system on/off.
2. Display panel.
3. Fahrenheit/Celsius selector.
4. Air conditioner on/off.
5. Select automatic operation.
6. Recirculation/fresh air.
7. Increase right-hand zone temperature.
8. Decrease right-hand zone temperature.
9. Select air distribution.
10. Heated rear screen/door mirrors.
11. Heated front screen (optional).
12. Defrost windows.
13. Select dual/single temperature zone.
14. Increase left-hand zone temperature.
15. Decrease left-hand zone temperature.
16. Option without front screen heater.

To switch the system on

The climate control system operates in position 'II' (run) of the ignition switch.

With the ignition key turned to the run position, the system will switch on in the operating mode last set.

For normal usage select AUTO mode.

AUTO mode

Automatic operation provides a controlled environment over a temperature range of 61°F to 89°F (17°C to 31°C) and should be regarded as the normal operating mode.



To select automatic climate control press the AUTO button; the

word AUTO appears on the LCD screen to confirm selection.

Select the required temperature.

Front and rear screen heating and timed air recirculation may be selected in AUTO mode. Selecting any other control will cancel AUTO operation.

Automatic operation cannot be deselected using the AUTO button.

To exit AUTO mode, select another mode or press the fan control knob to switch the system off.

Temperature selection



Separate controls allow the driver and passenger zone temperatures to be independently adjusted. Press the red buttons to increase temperature and the blue buttons to decrease temperature.

Both driver and passenger temperatures are always displayed.

Pressing the driver's buttons to select the maximum or minimum temperature settings causes the display to change to HI or LO respectively and cancel AUTO mode.

To quickly jump from HI or LO to a convenient midrange temperature of 73°F (23°C), press and hold AUTO for a few seconds.

Dual temperature zones



With the DUAL button LED illuminated, the system provides separate temperature control of the driver and passenger zones.

Press DUAL to de-select dual temperature control (LED off); the passenger temperature will change to that of the driver side. Using the driver side temperature control buttons will now change both zone temperatures together.

To select dual temperature control, press either the DUAL button or one of the passenger side red/blue temperature control buttons. The DUAL LED is illuminated.

External temperature

The external (EXT) temperature is displayed at the top of the screen.

Fahrenheit/Celsius selection



Press the button to change the scale between degrees Fahrenheit (°F) and degrees Celsius (°C) for the displayed internal and external (EXT) temperatures.

5-6 Climate control

Air recirculation

Timed air recirculation



Press the button briefly to select timed air recirculation.

The fresh air intake is opened and the button LED extinguished at the end of the time out period.

Latched air recirculation



Press and hold the button for a few seconds to select latched air recirculation. Selection is

indicated by the screen symbol, two beeps and the button LED flashing four times then remaining illuminated.

Selecting latched air recirculation cancels AUTO operation.

To deselect latched air recirculation, press the recirculation button again, or select AUTO.



WARNING:

Prolonged operation with recirculation selected in cold, damp conditions could result in interior condensation.

Windscreen defrost/demist

Frost and heavy misting



To remove frost or heavy misting from the windscreen, press the DEF button.

- The fan switches on automatically at maximum speed but the speed can be reduced manually if required.
- Air conditioning switches on automatically and cannot be deselected.
- Recirculation is cancelled and cannot be selected.
- The front screen heater and the rear screen heater/door mirror heaters switch on automatically, provided the engine is running.

To deselect defrost mode, press AUTO (recommended operating mode).

Light misting



To prevent or remove light windscreen misting, select manual air distribution to windscreen and feet (see page 5-7).

Heated screens and door mirrors



The front (F) and rear (R) or REAR) screen heaters may be switched on and

off in any mode, including system off, but only operate when the engine is running. The door mirror heaters are also controlled by the rear screen heater button.

The front screen heater (if fitted) switches off automatically after 4 minutes.

The rear screen and door mirror heaters switch off automatically after 10 minutes.

The windscreen heaters may be manually deselected during the timed period using the push buttons.

In cold ambient conditions, at the start of a journey, the front and rear screen heaters will switch on automatically for the timed period.

Where a front screen heater is not fitted, the windscreen has a wiper park zone heater which operates automatically with no manual control.

Air conditioning



Press to switch the air conditioning on or off.

The air conditioning system is controlled automatically in AUTO mode. Deselecting A/C cancels AUTO mode.

The air conditioning system is also switched on automatically in defrost mode (DEF) but cannot be deselected.

Fan speed



Set the fan speed as required with the rotary control knob. Fan speed is shown as a series of bars on the LCD screen.

When operating in AUTO mode, fan speed is controlled automatically (but not displayed) and any adjustment of the knob will cancel AUTO mode.

Note: In AUTO mode, the fan only operates at low speed, if heating is required, until the engine is warm.

Manual air distribution

Air distribution is automatically controlled in AUTO and defrost modes.



Press MODE to select manual air distribution. Four air distribution modes are available and are selected in succession by pressing the MODE button. A symbol is displayed for the selected mode.



Air flow distributed to the windscreen and feet; select to prevent or remove light misting and when heating the interior.



Air flow directed to foot level; select to heat the interior.



Air flow distributed to the face and feet.



Air flow directed at face level only; select to cool the interior.

To switch the system off



Press in the fan rotary control knob to switch the climate control system off.

If the fan control knob is pressed again, the system will switch on in the previous mode set.

Ram air

With the climate control system switched off, air recirculation is automatically selected (intake flap closed). To select fresh air with the system off, press one of the air distribution buttons.

With the fan switched off, the fresh airflow results from the forward motion of the vehicle (ram air effect).

5-8 Climate control

Automatic climate control with touch screen

The multi-function centre console provides all the controls and display information for the climate control system in addition to user control of other facilities (such as audio, telephone, navigation system).

The automatic control system (AUTO) may be overridden at any time. Defrost/demist operation is available and also manual selection of fan speed, air distribution, recirculation, air conditioning and windscreen heating.

Controls and displays

The climate control system has its own, manually selected, touch screen displays providing 'soft' control buttons. Touching the screen button with a finger has the same effect as pressing a push button. Refer to the general description and usage of the touch screen in Section 1 of this Handbook.

Note that using other systems and touch screens, such as audio or navigation, does not affect the climate control settings.

A number of push buttons are also used for climate control and are located around the touch screen. When a push button is pressed, selection of the function is confirmed by a beep and, on most buttons, illumination of an LED.

An LCD screen below the touch screen shows the interior temperatures set by the driver and passenger and the external (EXT) ambient temperature.

Panel illumination

With the exterior lighting switched on, the graphics on the panel controls are illuminated by low level backlighting.

The illumination level is adjusted by the common instrument panel dimmer control.

Controls

1. Select climate control touch screen.
2. Adjust fan speed.
3. Select automatic operation.
4. Decrease left-hand zone temperature.
5. Increase left-hand zone temperature.
6. LCD screen: Interior and exterior temperatures.
7. Decrease right-hand zone temperature.
8. Increase right-hand zone temperature.
9. Heated rear screen/door mirrors.
10. Heated front screen.
11. Defrost operation.
12. Select air recirculation.
13. Touch screen.



5-10 Climate control

Ignition on

The climate control system operates in position 'II' (run) of the ignition switch.

When the ignition is switched to run or the engine is started, the Jaguar logo will be displayed briefly followed by the last touch screen selected (e.g. radio).

The climate control system will be set to the climate operating mode selected previously.

Climate control touch screen displays

There are two climate control touch screen displays, one for the system on state and the other for system off/ram air mode. Smaller overlay displays appear briefly when selecting air recirculation or adjusting the fan speed.

Most climate functions can be selected using the peripheral push buttons without displaying the climate touch controls.

 To select the touch screen display, press the CLIMATE button.

To exit the climate control screen, select another system function, e.g. AUDIO.

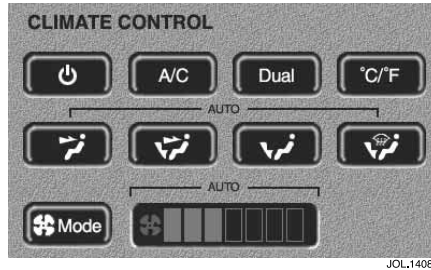

AUTO mode

Automatic operation provides a controlled environment over a temperature range of 61°F to 89°F (17°C to 31°C) and should be regarded as the normal operating mode.

 To select automatic climate control press the AUTO button. Select the required temperature.

The AUTO mode touch screen is shown above. If the touch screen is not displayed, press the CLIMATE button. Front and rear screen heating and timed air recirculation may be selected while remaining in AUTO mode. Selecting any other climate control push button or touch screen button will cancel AUTO operation.

Automatic operation cannot be deselected using the AUTO button. To exit AUTO mode, select another climate mode or touch the SYSTEM ON/OFF screen button to switch the system off.

Temperature selection

 Separate controls allow the driver and passenger zone temperatures to be independently adjusted. Press the red buttons to increase temperature and the blue buttons to decrease temperature.



The selected temperatures will appear on the LCD display below the touch screen. Pressing the driver's buttons to select the maximum or minimum temperature settings causes the LCD display to change to HI or LO respectively and cancel AUTO mode.

To quickly jump from HI or LO to a convenient midrange temperature of 73°F (23°C), press and hold AUTO for a few seconds.

Dual temperature zones



With the DUAL screen button illuminated, the system provides separate temperature control of the driver and passenger zones.

Touch DUAL to de-select dual temperature control; the passenger temperature will change to that of the driver side. Using the driver side temperature control buttons will now change both zone temperatures together. To select dual temperature control, either touch DUAL or press one of the passenger side temperature control buttons.

External temperature

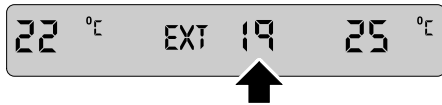

The external (EXT) temperature is displayed on the LCD screen.

Celsius/Fahrenheit selection



Touch the screen button to change the scale between degrees Celsius (°C) and degrees Fahrenheit (°F) for the displayed internal and external (EXT) temperatures.



JOL-1410Z

Timed air recirculation



Press the button briefly to select air recirculation for a timed period only; the overlay screen shown above will appear for a few seconds on top of the currently selected touch screen.

The fresh air intake is opened and the button LED extinguished at the end of the timed period.

Latched fresh air

Pressing the air recirculation button when the button LED is illuminated will cancel recirculation and allow fresh air into the vehicle.

Deselecting air recirculation cancels AUTO mode.



JOL-1411Z

Latched air recirculation



To latch air recirculation (so that it remains selected), press and hold the air recirculation button until the overlay screen changes from the timed to the latched recirculation symbol.

Selection is also indicated by two beeps and the button LED flashing four times then remaining illuminated.

Selecting latched recirculation cancels AUTO mode.



WARNING:
Prolonged operation with recirculation selected in cold, damp conditions could result in interior condensation.

5-12 Climate control

Windscreen defrost/demist

Frost and heavy misting



To remove frost or heavy misting from the windscreen, press the DEF button.

- The fan switches on automatically at maximum speed but the speed can be reduced manually if required.
- Air conditioning switches on automatically and cannot be deselected.
- Recirculation is cancelled and cannot be selected.
- The front screen heater and the rear screen heater/door mirror heaters switch on automatically, provided the engine is running.

To deselect defrost mode, press AUTO (recommended operating mode).

Light misting



To prevent or remove light windscreen misting, select manual air distribution to windscreen and feet (see page 5-13).

Heated screens and door mirrors



The front screen heater (F) and the rear screen heater (R) may be switched on and off in any mode, including system off, but only operate when the engine is running.



The door mirror heaters are also controlled by the rear screen heater switch.

The front screen heater (if fitted) switches off automatically after 4 minutes.

The rear screen and door mirror heaters switch off automatically after 10 minutes.

The windscreen heaters may be manually deselected during the time out period using the push buttons.

In cold ambient conditions, at the start of a journey, the front and rear screen heaters will switch on automatically for the timed period.

Where a front screen heater is not fitted, the windscreen has a wiper park zone heater which operates automatically with no manual control.

Air conditioning



Touch the A/C screen button to switch the air conditioning on or off.

The air conditioning system is controlled automatically in AUTO mode.

Deselecting A/C cancels AUTO mode.

The air conditioning system is also switched on automatically in defrost mode (DEF) but cannot be deselected.

Fan speed



Set the fan speed as required using the rocker button.

Fan speed is shown as a series of bars on the touch screen.

If the fan speed is changed while a non climate control touch screen is displayed, an overlay display showing the fan speed bars will appear for a short period.

When operating in AUTO mode, fan speed is controlled automatically (but not displayed) and any adjustment of the control button will cancel AUTO mode.

Note: In AUTO mode, the fan only operates at low speed, if heating is required, until the engine is warm.

Fan Mute



To reduce the interior noise level, the fan speed may be quickly reduced to a preset level by touching the 'Mute' screen button.

Selecting 'Mute' will cancel AUTO mode but touching the 'Mute' button again will return operation to the previous state.

If voice activation is fitted, the climate control system will automatically prevent any increase in fan speed while speech commands are given.

Manual air distribution

Air distribution is automatically controlled in AUTO and defrost modes.

Touch one of the four air distribution buttons on the screen to cancel the current mode and select manual operation.

The air distribution options are:



Air flow directed at face level only; select to cool the interior.



Air flow distributed to the face and feet.



Air flow directed to feet level; select to heat the interior.



Air flow distributed to the windscreen and feet; select to prevent or remove light misting and when heating the interior.

5-14 Climate control



JOL1412Z



JOL1413Z

Switching climate control off



To switch the system off, touch the System On/Off button on the CLIMATE CONTROL screen. The touch screen will change to the system off/ram climate control screen above.

Pressing the System On/Off button will return the system to the previous state.

It is recommended to select AUTO to switch the system on again.

Ram air

With the climate control system switched off, air recirculation is automatically selected (intake flap closed).

To select fresh air with the system off, touch the ram air screen button (bottom left on illustration). The intake flap will open with air distribution to face level automatically selected.

Any of the other air distribution modes may be selected manually using the touch screen.

With the fan switched off, the fresh airflow results from the forward motion of the vehicle (ram air effect).

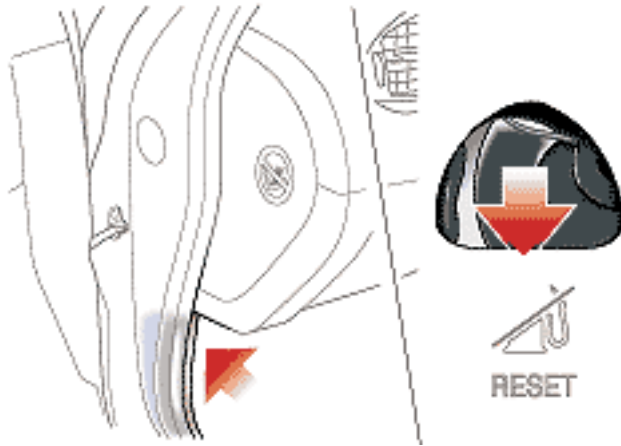

Inertia switch

In the event of an accident, an inertia switch will trip, isolating fuel pump operation. Once the switch has tripped it must be reset before attempting to restart the engine.

The inertia switch is located behind the trim on the left-hand side of the vehicle, forward of the front door post, below the fascia. A finger access hole in the trim allows the driver to reset the switch.

Resetting the switch



WARNING:

To avoid the possibility of fire or personal injury, do not reset the inertia switch if you see or smell fuel.

If no fuel leak is apparent, reset the inertia switch as follows:

1. Turn the ignition switch to position '0'.
2. Press down the rubber reset button on the top of the inertia switch.
3. Turn the ignition switch to position 'II', pause for a few seconds, then return the key to position '0'.
4. Make a further check for fuel leaks.

6-2 Roadside emergency

Emergency starting

Rolling start

If the vehicle battery is discharged, inserting the ignition key may not release the electronically controlled steering lock. Also, if the electric parkbrake was applied before the battery was discharged (e.g. vehicle unused for a long period), it will not be possible to release the parkbrake.

In this situation, a manual transmission vehicle cannot be pushed or tow started. If the parkbrake has not been applied, it could be dangerous to attempt to move the vehicle with the steering locked.

Do not push or tow start a vehicle with automatic transmission even with the steering lock and parkbrake released. With a discharged battery it will also not be possible to move the drive selector from the 'P' position.



WARNING:

A vehicle start by pushing or towing must not be attempted because it is possible that the steering lock may not be disengaged. Only jump lead starting or the fitting of a fully charged battery is recommended.

Emergency starting using jump leads

Both the booster and discharged battery should be treated with great care when using jump leads. Always use high quality leads capable of carrying the starter current of the vehicle to be started.

Before commencing, the following precautions must be taken:

- When the battery of another vehicle is being used, ensure that the vehicles do not touch. Alternatively, remove the charged battery and place near to, not on, the vehicle with the discharged battery.
- Ensure that both vehicles have all electrical services OFF, the parkbrakes applied and neutral (manual transmission) or 'P' (automatic transmission) selected.
- Where the jump leads are of a different colour, e.g. red and black, use red for positive (+). This aids identification and helps to avoid crossing positive (+) to negative (-). Take extra care to avoid crossing the polarity when using cables of the same colour.

Caution:

1. **If using a jump start vehicle, under no circumstances should the vehicles come into contact with each other. This could establish an earth connection, which may cause sparks and damage.**
2. **Do not run the jump start vehicle's engine when boost starting a Jaguar Vehicle. If the jump start vehicle's engine is running and the jump leads are disconnected, damage to the Jaguar vehicle's electrical system will result.**
3. **The booster battery voltage must not exceed 12 volts.**

To gain access to the battery, fold the luggage compartment floor panel forward. If a space saver spare wheel is fitted it will be necessary to remove the under floor stowage tray.

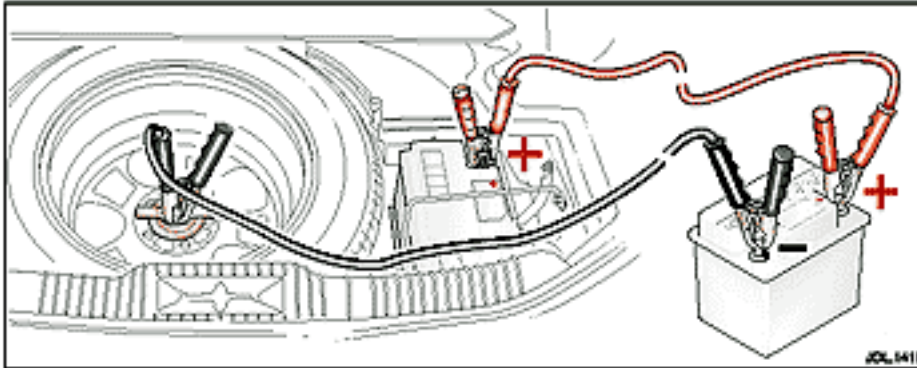

Emergency starting using jump leads (continued)

The following procedure must be followed exactly, being careful not to cause sparks:

1. Unclip the battery positive (+) terminal cover.
2. Attach one end of the red jump lead to the positive (+) terminal of the booster battery and the other end to the positive (+) terminal of the discharged battery. Make sure that a good connection is made.

Caution: Do not connect the negative jump lead directly to the negative (-) terminal of the discharged vehicle.

3. Attach one end of the black jump lead to the negative (-) terminal of the booster battery and the other end to an earth point on the vehicle being started. (If your Jaguar has the discharged battery use only the spare wheel locking stud, as shown.) The earth point must be at least 12 inches (305 mm) from the discharged battery. Make sure that a good connection is made.

4. When started, allow the engine to idle for five minutes before disconnecting the cables.
5. Disconnect the black jump lead from the earth point and the booster battery negative (-) terminal.
6. Disconnect the red jump lead from the positive (+) terminals of both batteries.
7. Refit the positive (+) terminal cover.
8. Refit the luggage compartment floor panels.

After starting the engine, it may be necessary to reset the electric parkbrake as described in Section 4. See also **After battery reconnection**, Section 7.

6-4 Roadside emergency

Wheel changing and jacking

Be prepared for a flat tyre. Know where equipment is stowed and read the wheel changing and jacking instructions carefully.

Pull off the road completely, clear of all traffic and park on as level, solid ground as possible. Switch on hazard warning lights and, where legally required, display the warning triangle.



WARNING:

It can be dangerous to change a wheel when the vehicle is on a slope or soft, uneven ground.

The spare wheel and jacking equipment are stored under the luggage compartment floor panel.

To remove the spare wheel, fold the luggage compartment floor panel towards the rear seats. Remove the tray containing the jacking equipment to gain access to the wheel. Unscrew the retaining nut and remove the spare wheel. Remove the jack and wheel nut wrench.

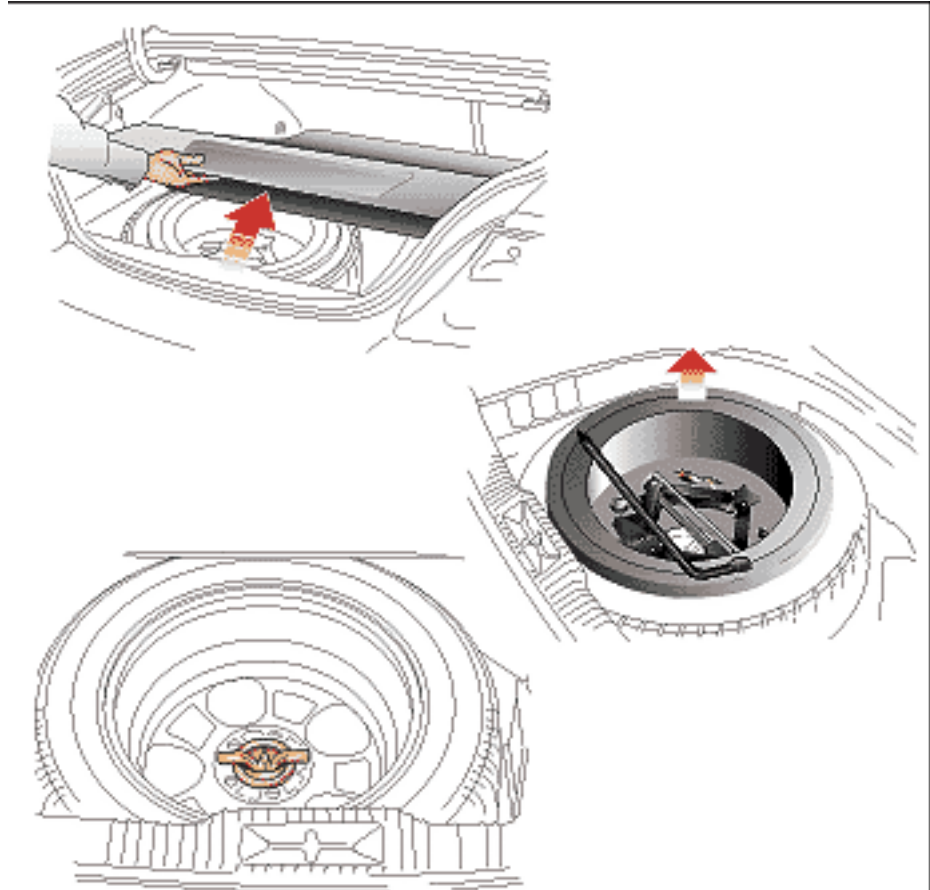

Temporary-use spare wheel

Observe the following warnings before using the wheel:



WARNING:

1. Please note temporary-use spare wheel warning label. Adhere to instructions on the label. Failure to comply can be dangerous.
2. When a temporary-use spare wheel is fitted, drive with caution and replace with the specified wheel and tyre as soon as possible.
3. Do not fit more than one temporary-use spare wheel and tyre assembly at one time.
4. The temporary-use spare wheel must be inflated to the correct pressure. See Section 8.
5. Temporary-use spare wheel, maximum speed is 50 mph (80 km/h).

Note: Maintenance information for the temporary-use spare wheel is the same as given for normal tyres.

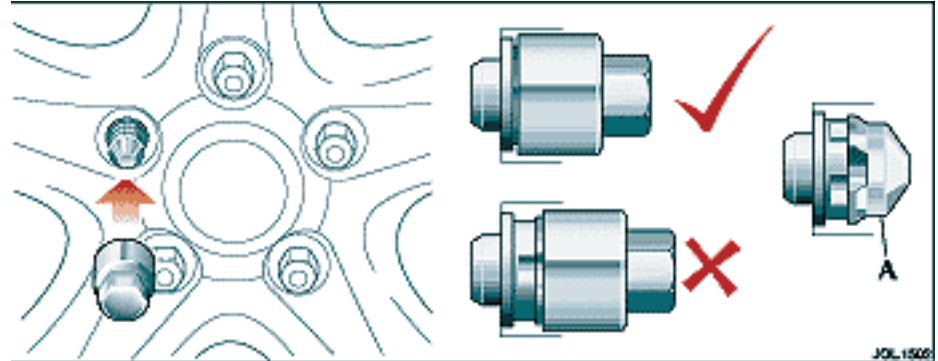

Locking wheel nuts

Where Jaguar locking wheel nuts are fitted (one on each wheel), they can only be removed using the correct key socket.

The locking wheel nut comprises two grooved parts, front and rear, which must be turned together to allow the nut to be fitted or removed.

To remove the nut, the front and rear grooves must be aligned. Locate the key socket in the grooves and push it fully over both parts of the nut. Fit the wheel nut wrench over the key socket and loosen the locking wheel nut.

Attempting to remove the nut without the correct key socket (such as attempted theft) or with the socket not located over the rear part of the nut, will cause the front part only (A) to turn.

If this has happened, rotate the front part with the key socket until the grooves are re-aligned and then push the socket fully over the nut.

Should a new key socket be required, contact your Jaguar Dealer. Proof of vehicle ownership will be required.

6-6 Roadside emergency

Wheel changing

1. Ensure that all passengers are in a safe place, clear of the vehicle.
2. Apply the parkbrake and select gear position 'P' (Park) or select a low gear on a manual transmission vehicle.
3. Ensure that the jack is placed on firm and level ground.

Note: When one rear wheel is lifted off the ground the selection of a low gear on manual vehicles or automatic transmission 'P' (Park) position will not prevent the vehicle from moving and possibly slipping off the jack.

WARNING:

1. **Before attempting to lift the vehicle with the jack, chock the wheel diagonally opposite to the wheel being replaced to prevent the vehicle from rolling when jacked up. A wheel chock is supplied with the jacking equipment for this purpose.**
2. **Never work under the vehicle using only the jack as a support, always use axle stands or suitable supports under the jacking points.**

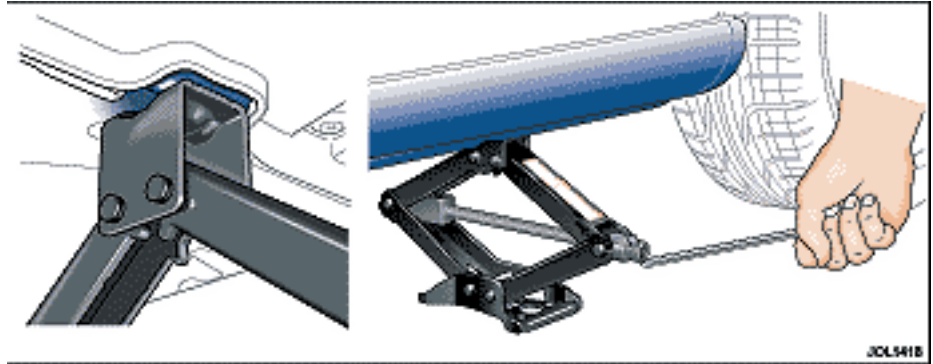

Before raising the vehicle slacken but do not remove the wheel nuts.

Observe the instructions printed on the jack.

Use the jack only for lifting the vehicle during wheel changing, and only use the jack which is stored in the vehicle.

Do not start or run the engine while the vehicle is only supported by a jack.

There are four jacking points, two each side of the vehicle on the underside of the floor. These provide positive location for the jack. The front jacking point is approximately 7 inches (180 mm) from the front wheel and the rear is approximately 11 inches (280 mm) forward of the rear wheel.

The simplest way to correctly locate the jacking point is to feel along the sill panel to the cut-away portion and then fit the jack to the body, **not to the sill panel.**

On some models, the jack location points are identified by indented, triangular markers on each sill panel.

Caution: Ensure before raising the vehicle that the jack is correctly positioned to avoid any damage to the vehicle sills or sill panels. Use only the correct jacking points, never use bumpers or any other part of the body to lift the vehicle.



WARNING:

- 1. Do not attempt to lift the vehicle unless the jack head is fully engaged in the jacking point.**
- 2. Ensure that the parkbrake is applied.**

Place the jack squarely beneath the appropriate jacking point. Ensure that the jack head is fully engaged. Carefully raise the vehicle by turning the handle. Stop jacking the vehicle when the tyre just clears the ground. Minimum tyre lift gives maximum vehicle stability.

Remove the wheel nuts and the wheel.

When changing the alloy road wheels, transfer the centre badge to the replacement wheel (when a full size spare wheel is used). Using the plastic tipped end of the wheel nut wrench handle from the inside of the wheel, push the centre badge from its housing. Push the centre badge into the replacement wheel. If the temporary-use spare wheel is to be fitted, keep the centre badge safely and fit it to the repaired full size wheel when it has been refitted.

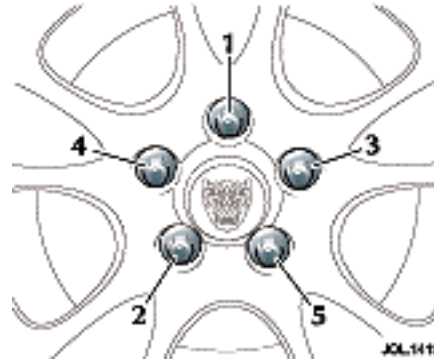

Fit the spare wheel and loosely secure with the wheel nuts.

Using the wheel nut wrench, lightly tighten the wheel nuts alternately using the sequence shown in the illustration.

Lower the jack and tighten the wheel nuts alternately, **DO NOT OVERTIGHTEN.**

At the earliest opportunity have the wheel nuts tightened with a torque wrench to 92 lb.ft (125 Nm).

This torque must not be exceeded.

Stowing the equipment

Stow the replaced road wheel in the luggage compartment, position the wheel and secure with the retaining nut.

Place the storage tray with the jack and wrench over the wheel.

Reposition the luggage compartment floor panel.

Note: Examine the jack occasionally and clean and grease the threads to ensure it is always ready for an emergency.



WARNING:

When the temporary-use spare wheel has been fitted, drive with caution and replace with the specified wheel and tyre as soon as possible.

6-8 Roadside emergency

Vehicle recovery

The preferred vehicle recovery method is by using a flat bed transporter or rear suspended tow.

Caution:

- If the vehicle has defective transmission, to prevent further damage, it must be towed with the rear wheels clear of the ground.
- Ensure that the recovery team do not tow with sling-type equipment since damage to the bodywork may result.
- Do not tow vehicle by suspending the front end.

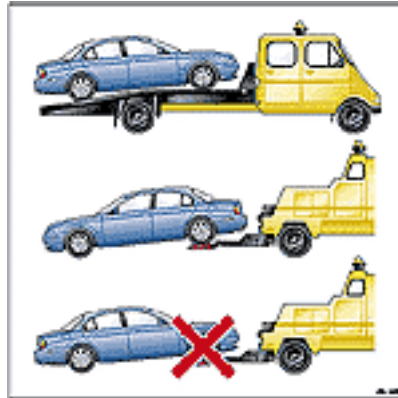

Transporting

If the vehicle is being transported on a trailer or vehicle flat bed transporter, the parkbrake must be applied, the wheels chocked and the gear selector lever moved to position 'N' or 'D' but NEVER to 'P'.

The vehicle must be securely tied down to the transporter or trailer.

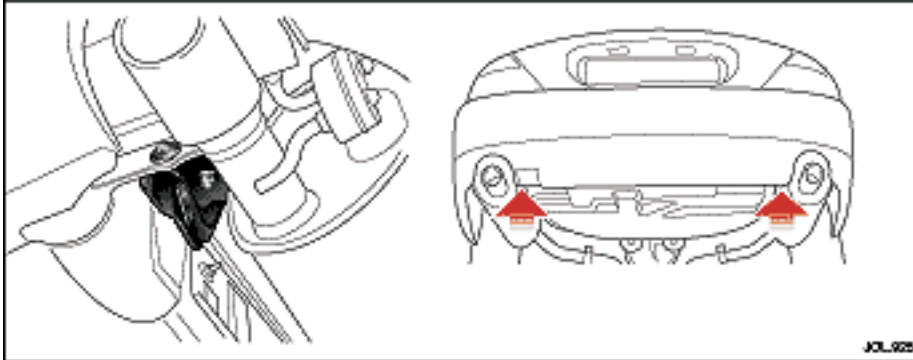

Transporter tie down brackets



WARNING:

Avoid body contact with a hot exhaust pipe when using the tie down points.

There are two transporter tie-down brackets on the vehicle rear underbody. The brackets are inboard of the rear silencer tail pipes.

Use straps on the front wheels/tyres to secure the vehicle for transportation.

The towing eye is not designed for securing the vehicle during transportation.

Vehicle failure

The removable towing eye is primarily for emergency use when towing for SHORT DISTANCES, e.g. removing the vehicle if it is causing an obstruction or for winching the vehicle onto a recovery transporter. To prevent damage to the automatic transmission whilst the vehicle is being towed with the rear wheels on the ground, towing distance must be restricted to 0.5 miles (0.8 kilometres). Towing speed must not exceed 30 mph (48 km/h).

Always obey towing regulations. In certain countries the registration number of the towing vehicle and an 'ON TOW' sign or warning triangle must be displayed in a prominent position at the rear of the vehicle being towed.

When being towed, the vehicle's gear selector lever must be in neutral (position 'N') with the ignition key turned to position 'II' to release the steering lock and render the indicators, horn and brake lights operational.



WARNING:

When the engine is not running the steering and brakes will no longer be power-assisted. Therefore, be prepared for relatively heavy steering and the need for greatly increased brake pedal pressure.

6-10 Roadside emergency

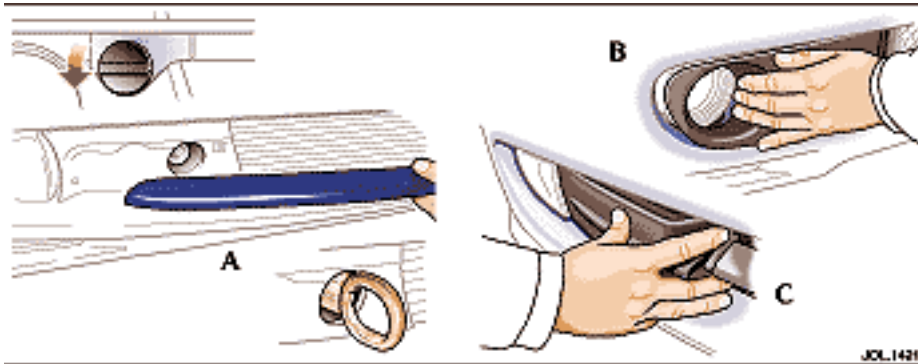

Towing eye

A screw-in towing eye is provided in the luggage compartment with the jack and can be fitted to the front or rear of the vehicle. The towing eye has a left-hand thread and must be screwed in an anti-clockwise direction when fitting.

Caution:

1. The towing eye is not suitable for 'solid bar' towing.
2. Care must be taken to avoid damaging the bumpers and front apron.

Front tow point

The front towing point is located behind a grille vane or plastic cover on the left-hand side of the vehicle (as viewed from the front).

- A. The grille vane is secured by three fasteners on the underside. Turn the fasteners anti-clockwise to loosen, then remove the grille vane.
- B. On 'R' performance vehicles, press the plastic cover to the right to unclip. Remove the cover.
- C. On vehicles fitted with adaptive cruise control (ACC), unclip the right-hand side of the plastic cover to remove.

Screw the towing eye into the vehicle, right up to the shoulder, turning anti-clockwise.

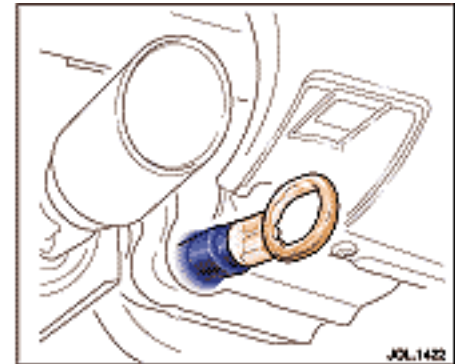

Rear tow point



WARNING:
Avoid body contact with a hot exhaust pipe when fitting the eye to the rear towing point.

The rear towing point is alongside the left-hand exhaust pipe.

Remove the small cover from the bumper. Remove the bung and screw the towing eye into the vehicle, right up to the shoulder, turning anti-clockwise.

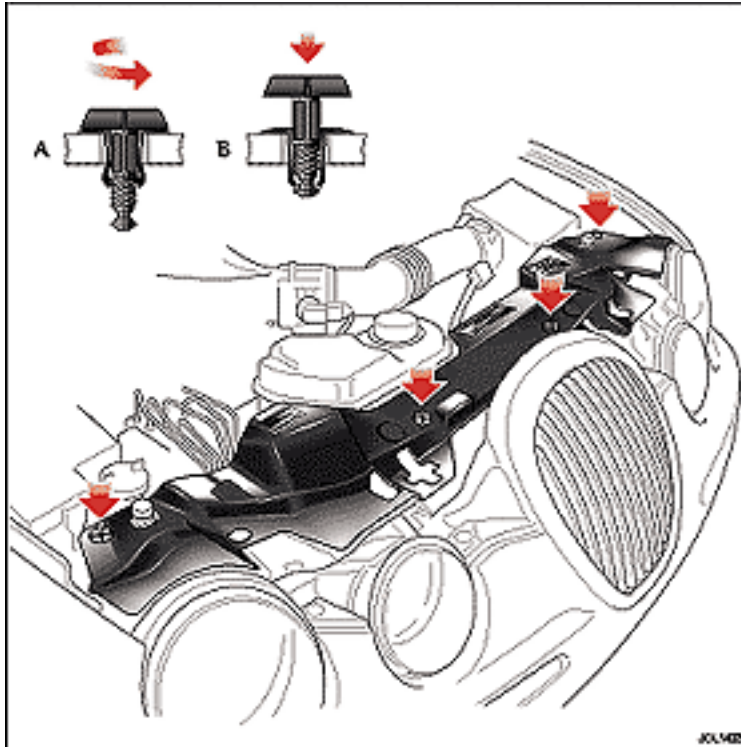

Bulb renewal

It is important that only Jaguar bulbs of the type specified are used when renewing bulbs.

Before renewing bulbs, switch off the ignition and light switches.

Top cover

To gain access to the headlamp units, the top cover must be removed.

Turn the fasteners (A) a quarter turn anti-clockwise and then remove the top cover.

After changing the defective bulb, refit the cover and push the fasteners (B) in place to retain the cover.

6-12 Roadside emergency

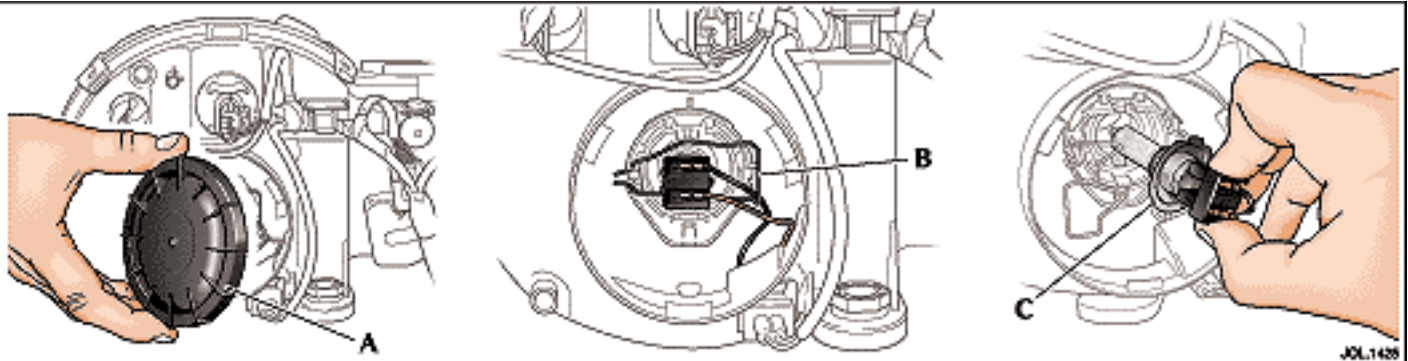

Headlamp – bulb renewal

Halogen bulbs are used in the main beam (inner headlamp) positions.

Either halogen bulbs or the optional High Intensity Discharge (HID) Xenon light system are fitted in the dipped beam (outer) headlamp positions.

Where HID lighting is fitted, refer to your dealer if the headlamp fails to operate.

Caution: Halogen bulbs will be damaged if touched by hand or contaminated with oil or grease. It is important to use clean gloves or cloth when handling a bulb which is to be used again. A contaminated bulb may be cleaned with methylated spirit before refitting.

Dipped beam (outer) headlamp

Open the hood.

Remove the top cover as shown on page 6-11.

Turn the circular cover (A) anti-clockwise and remove.

Press the spring clip (B) towards the bulb and downwards to release the bulb.

Remove the bulb/connector (C) from the headlamp assembly. Pull the connector from the bulb.

Attach the connector to the new bulb, type H7 for dipped beam, and fit to the headlamp. The bulb will only correctly fit in one position.

Engage the spring clips to retain the bulb and then fit the circular cover.

Refit the top cover and close the hood.

It is advisable to have the headlamp aim checked by a Dealer after bulb renewal.

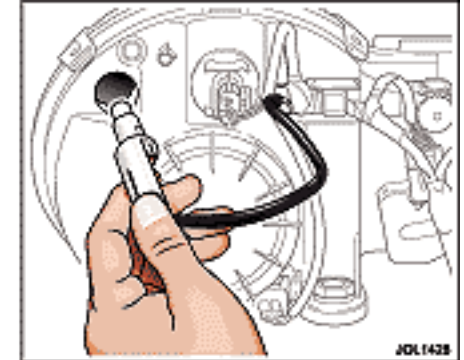
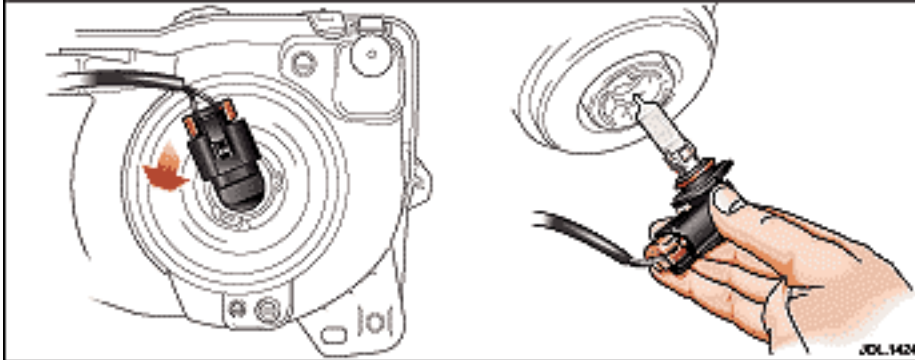

Main beam (inner) headlamp

Open the hood.

Remove the top cover as shown on page 6-11.

Turn the bulb holder a quarter turn anti-clockwise and remove the bulb and holder from the lamp unit.

Fit a new bulb to the holder, type HB3 for main beam.

Fit the holder to the lamp unit, the bulb will only correctly fit in one position.

Refit the top cover and close the hood.

Front parking (side) light – bulb renewal

Open the hood.

Remove the top cover as shown on page 6-11.

The front parking lights are contained within the outer headlamp units.

Rotate the bulb holder anti-clockwise and remove from the headlamp.

Pull the capless bulb from the holder and fit a new one of the correct type, W5W.

Reposition the bulb holder in the headlamp unit and turn clockwise.

Refit the top cover and close the hood.

6-14 Roadside emergency

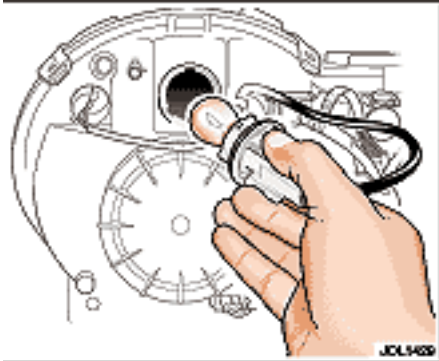

Front direction indicator – bulb renewal

Remove the top cover as shown on page 6-11.

The bulb is contained within the outer headlamp. Turn the holder a quarter turn anti-clockwise and remove the bulb and holder.

Remove the bulb and fit a new one of the correct type, 3457 AK.

Fit the holder to the lamp unit, it will only fit in one position.

Refit the top cover and close the hood.

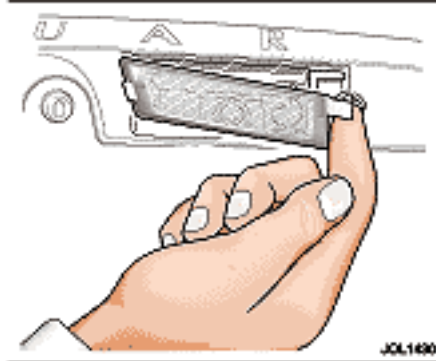

Number plate light – bulb renewal

Push the lens clip sideways and remove the lens from the vehicle.

Remove the bulb and fit a new one of the correct type, W5W.

Refit the lens by pressing it firmly into the recess until it clicks into place.

Front fog lamp – bulb renewal

It is recommended that the front fog lamp bulb, type H3, is renewed by a Jaguar Dealer.

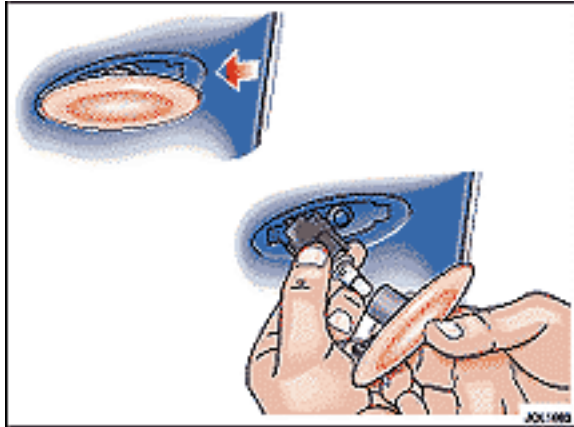

Side repeater indicator – bulb renewal

Remove the light unit from the front wing panel by pressing the unit forwards or rearwards to compress the spring clip and remove the complete unit.

Twist the bulb anti-clockwise and remove.

Fit a new bulb of the correct type, W5W.

Press the unit into the recess until it clicks into place.

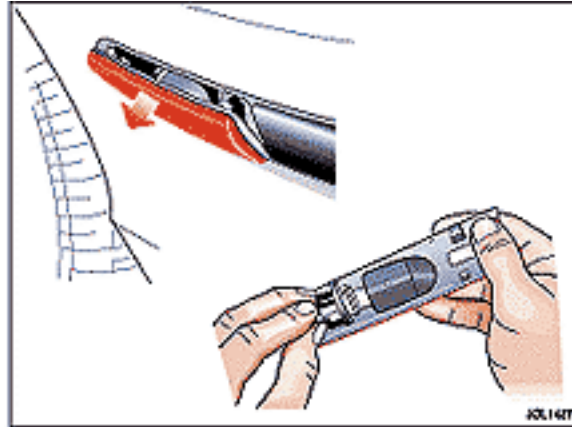

Side marker – bulb renewal

Remove the light unit by pressing the lens downwards to compress the spring clips. Gently ease the top of the lens from the bumper and remove the complete unit.

Twist the bulb holder anti-clockwise and remove the holder and bulb from the lens.

Fit a new bulb of the correct type, W5W.

Refit the bulb holder complete with bulb to the lens unit.

Press the unit into the recess until it clicks into place.

6-16 Roadside emergency

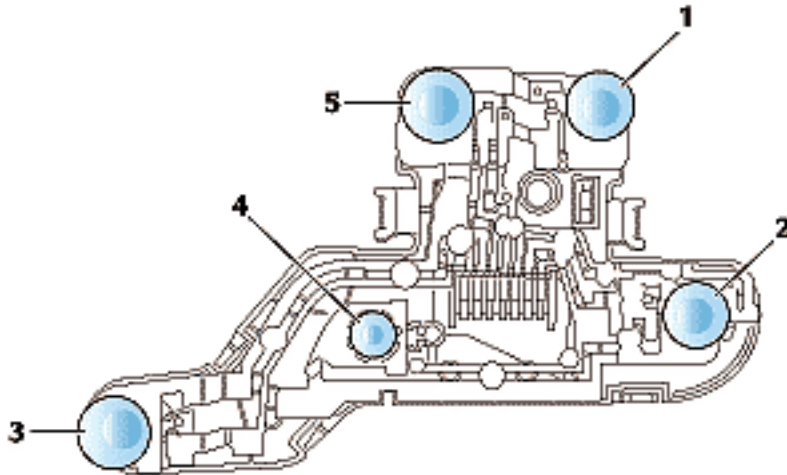

Rear light assembly – bulb renewal

The rear light assembly has the following bulbs:

1. Reverse light, type P21W.
2. Stop/tail light, type P21/4W.
3. Fog light, type P21W.
4. Tail light, type R5W.
5. Direction indicator, type 3457 AK.

Ensure that the lights and ignition switch are OFF before removing any bulbs.

Open the luggage compartment, loosen the side carpet and unclip the rear light bulb carrier.

Remove the faulty bulb and fit a new one of the correct type, as illustrated on the bulb holder. Fitment of the correct type is essential.

Refit the bulb carrier assembly, ensuring that the clips are correctly secured.

Refit the carpet.

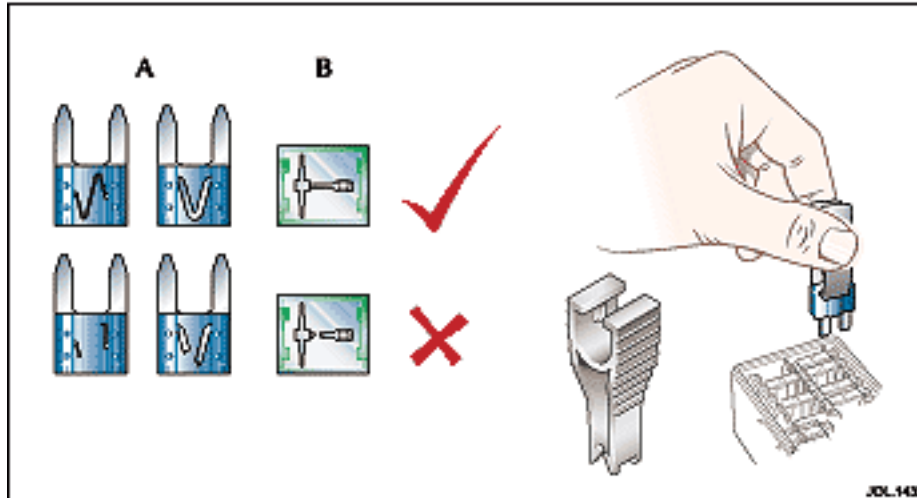

Fuses and fuse boxes

Fuse failure is identified by an inoperative circuit.

Do not fit a new fuse if the wiring is damaged; contact a Jaguar Dealer. After renewing a fuse have the circuit checked by a Jaguar Dealer.

Two types of fuses are fitted in the fuse boxes, a mini-type (A) and a cartridge-type (B).

A special tool for removing and replacing mini-fuses is provided in the engine compartment fuse box, together with spare fuses.

Use only the spare fuses supplied. If a spare fuse is used, renew it with a Jaguar approved fuse of the **same** amperage rating.

Checking and renewing a blown fuse

Make sure the new fuse is the correct rating (amperage).

Fuses are colour coded according to the amperage and the rating is also marked on each fuse.

6-18 Roadside emergency

Mini-fuse replacement

Push the tool on to the suspect mini-fuse and withdraw it.

If the wire in the fuse is broken, the fuse has blown.

Fit a new fuse using the tool.

Cartridge fuse replacement

Pull the suspected blown fuse from its holder.

If the wire in the fuse is broken, the fuse has blown.

Push a new fuse into the holder.



WARNING:

1. Do not fit a fuse of a different amperage from that removed. The electrical circuits may become overloaded with the subsequent possibility of a fire.
2. No attempt should be made to repair a fuse that has blown as this may cause a fire hazard or serious damage elsewhere in the electrical circuit.

Fuse box locations

There are three separate fuse boxes fitted to the vehicle, each one containing fuses protecting a different group of circuits.

They are located in:

- A. The engine compartment.
- B. The passenger compartment.
- C. The luggage compartment.

Caution: When a fuse box lid is removed, take care to protect the box from moisture, and refit the lid at the earliest opportunity.

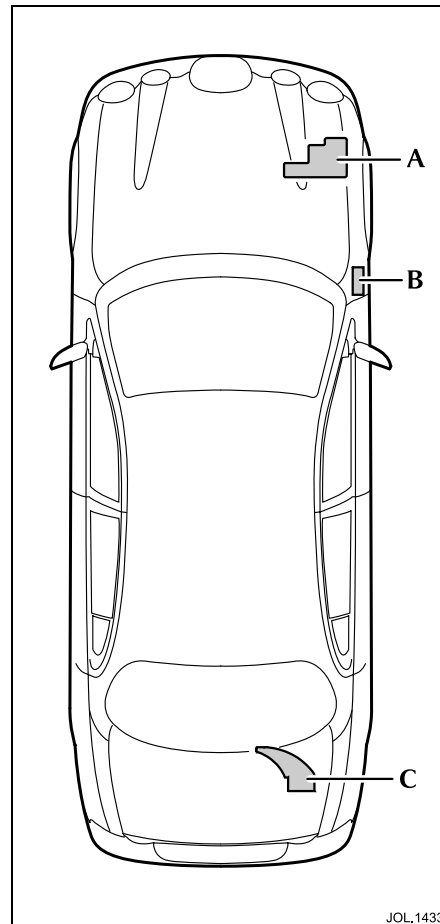

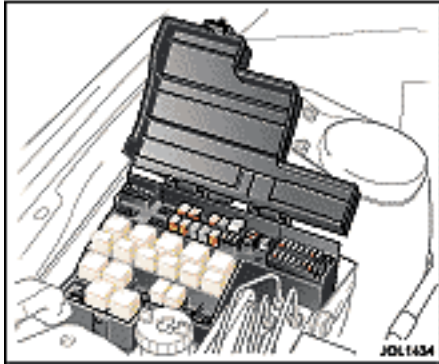

Engine compartment fuse box

The fuse box is located in the engine compartment on the right-hand side adjacent to the windscreen wash reservoir.

Caution: When a fuse box lid is removed, take care to protect the box from moisture, and refit the lid at the earliest opportunity.

Remove the fuse box lid by pressing the retaining lugs and lifting.

When refitting, press the fuse box lid in the area of the retaining lugs until the lid engages.

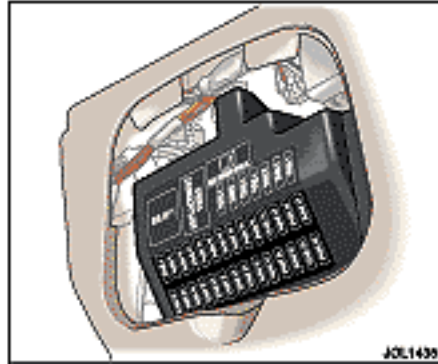

Passenger compartment fuse box

The passenger compartment fuse box is located on the right-hand side trim panel in the footwell.

Remove the fuse box lid by pressing the retaining lugs and lifting.

When removing and replacing mini-fuses, use the special tool provided in the engine compartment fuse box lid, together with spare fuses.

When refitting, press the fuse box lid in the area of the retaining lugs until the lid engages.



Luggage compartment fuse box

A fuse box is located in the luggage compartment, situated forward of the battery.

Fold the luggage compartment floor panel to gain access to the fuse box.

Remove the fuse box lid by pulling the retaining clips and pulling the lid upwards.

When removing and replacing mini-fuses, use the special tool provided in the engine compartment fuse box lid, together with spare fuses.

Reposition the lid and press down until the retaining clips engage.

Replace the floor panel.

6-20 Roadside emergency

Fuse and Relay Positions

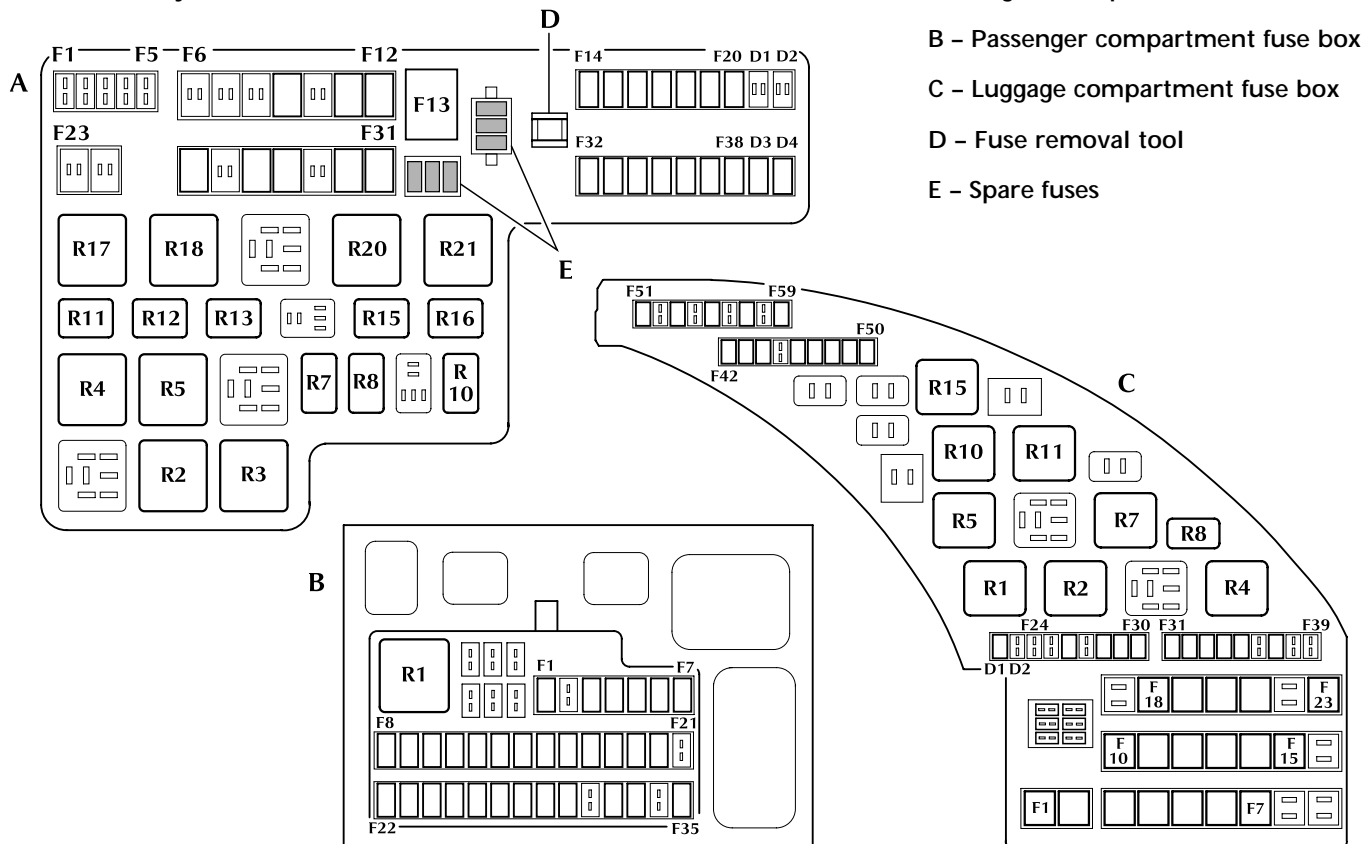

Engine compartment fuse box – fuses

Fuse No	Fuse Type	Rating (amps)	Colour	Circuit
F1				Not used.
F2				Not used.
F3				Not used.
F4				Not used.
F5				Not used.
F6				Not used.
F7				Not used.
F8				Not used.
F9	Cartridge	50A	Red	Engine management system power supply.
F10				Not used.
F11	Cartridge	30A	Pink	Headlamp powerwash.
F12	Cartridge	20A	Blue	Wipers.
F13	Cartridge	80A	Black	Cooling fan.
F14	Mini	15A	Blue	Right-hand dipped beam high intensity discharge (HID) lamp.
F15	Mini	15A	Blue	Front fog lamps.
F16	Mini	15A	Blue	Horns.
F17	Mini	15A	Blue	Fuel injectors.

6-22 Roadside emergency

Fuse No	Fuse Type	Rating (amps)	Colour	Circuit
F18	Mini	20A	Yellow	Throttle motor.
F19	Mini	10A	Red	Ignition coil on plugs supply.
F20	Mini	30A	Green	Right-hand oxygen sensor heaters.
F21/D1				Not used.
F22/D2				Not used.
F23				Not used.
F24				Not used.
F25	Cartridge	40A	Green	Right-hand windscreen heater (if fitted) or wiper park heater.
F26				Not used.
F27	Cartridge	30A	Pink	Starter motor solenoid.
F28	Cartridge	30A	Pink	ABS pump motor.
F29				Not used.
F30	Cartridge	40A	Green	Left-hand windscreen heater (if fitted).
F31	Cartridge	30A	Pink	ABS module (ABS valves).
F32	Mini	10A	Red	Air compressor clutch, auxiliary coolant pump.
F33	Mini	15A	Blue	Engine control module and transmission control module battery supply.
F34	Mini	15A	Blue	Left-hand dipped beam high intensity discharge (HID) lamp.
F35	Mini	30A	Green	Left-hand oxygen sensor heaters.

Fuse No	Fuse Type	Rating (amps)	Colour	Circuit
F36	Mini	15A	Blue	Intercooler pump (supercharged model).
F37	Mini	15A	Blue	Air flow meter, purge valve, canister close valve, inlet manifold tuning valves (V6 only), EGR valve (V8 only), air filter solenoid (V8 S/C only).
F38	Mini	10A	Red	Engine control module ignition supply, cooling fan module, air conditioner clutch relay.
D3	Diode			Ignition relay.
D4	Diode			Engine management control relay.

6-24 Roadside emergency

Engine compartment fuse box – relays

Relay No	Type	Rating (amps)	Circuit
R1	ISO		Not used.
R2	ISO	40A	Heated oxygen sensors.
R3	ISO	40A	Ignition.
R4	ISO	40A	Throttle.
R5	ISO	40A	Engine management system.
R6			Not used.
R7	MICRO	20A	Auxiliary coolant pump.
R8	MICRO	20A	Air compressor clutch.
R9			Not used.
R10	MICRO	20A	HID lamp – left-hand side.
R11	MICRO	20A	Front fog lamps.
R12	MICRO	20A	Horn.
R13	MICRO	20A	HID lamp – right-hand side.
R14			Not used.
R15	MICRO	20A	Wiper speed high/low.
R16	MICRO	20A	Wiper run/park.
R17	ISO	40A	Left-hand windscreen heater.

Relay No	Type	Rating (amps)	Circuit
R18	ISO	40A	Headlamp washer pump.
R19			Not used.
R20	ISO	40A	Starter motor solenoid.
R21	ISO	40A	Right-hand windscreen heater (if fitted) or wiper park heater.

6-26 Roadside emergency

Passenger compartment fuse box – fuses

Fuse No	Fuse Type	Rating (amps)	Colour	Circuit
F1	Mini	5A	Brown	Engine control module/crankshaft sensor.
F2				Not used.
F3	Mini	5A	Brown	ABS/Dynamic stability control module, ACC module.
F4	Mini	5A	Brown	Inertia switch (fuel pump relay, ignition control relay, rear electronics module), instrument cluster, brake pedal cruise de-activation switch.
F5	Mini	10A	Red	Restraint control module, airbag occupant sensor, passenger airbag de-activation lamp.
F6	Mini	10A	Red	OBDII connector.
F7	Mini	5A	Brown	Driver's door module, seat logic, battery backed sounder, road pricing (Singapore), security LED.
F8	Mini	5A	Brown	Front right turn indicator, sidemarker, park, repeater lamps.
F9	Mini	10A	Red	Right-hand dipped beam, left-hand HID relay coil.
F10	Mini	5A	Brown	Front left turn indicator, sidemarker, park, repeater lamps.
F11	Mini	10A	Red	Left-hand main beam.
F12	Mini	15A	Blue	Screenwash pump.
F13	Mini	5A	Brown	Instrument cluster.
F14	Mini	10A	Red	Climate control system, two stage adaptive damping control module.
F15	Mini	5A	Brown	Ignition switch feed (RUN) to alternator, 'J'-gate, transmission control module.

Fuse No	Fuse Type	Rating (amps)	Colour	Circuit
F16	Mini	10A	Red	Passenger/driver heated seat modules, electrochromic mirror, rain sense module, headlamp levelling, ACC chime module.
F17	Mini	5A	Brown	Instrument cluster (airbag warning light, alternator warning light, seatbelt chime).
F18	Mini	20A	Yellow	Radio head unit, touchscreen/display unit.
F19	Mini	15A	Blue	Steering column tilt and reach motors.
F20	Mini	10A	Red	Logic supply to instrument cluster, climate control system, front electronic module, rear electronic module.
F21				Not used.
F22	Mini	10A	Red	Driver's door module battery supply (driver's door mirror, locks).
F23	Mini	10A	Red	Right-hand main beam.
F24	Mini	5A	Brown	Passive anti-theft system.
F25	Mini	10A	Red	Left-hand dipped beam, right-hand HID relay coil.
F26	Mini	10A	Red	Electric parkbrake switch illumination, AM/FM antenna amplifier, sunblind motor, accessory socket relay.
F27	Mini	10A	Red	Radio head unit, touchscreen/display unit, navigation module, voice control, VICS (Japan), centre console switchpack.
F28				Not used.
F29	Mini	5A	Brown	Voice control, reversing aid module, telephone transceiver, front electronic module.
F30	Mini	10A	Red	Front electronic module power.
F31				Not used.

6-28 Roadside emergency

Fuse No	Fuse Type	Rating (amps)	Colour	Circuit
F32	Mini	20A	Yellow	Accessory relay (cigar lighter, power point).
F33	Mini	10A	Red	Front electronic module (instrument dimming, fuel/luggage compartment switchpack).
F34				Not used.
F35	Mini	5A	Brown	Brake on/off switch, cruise control cancel switch, bottom of clutch switch.

Passenger compartment fuse box – relays

Relay No	Type	Rating (amps)	Colour	Circuit
R1	ISO	40A		Accessory (cigar lighter, power point).

Luggage compartment fuse box – fuses

Fuse No	Fuse Type	Rating (amps)	Colour	Circuit
F1	Cartridge	40A	Green	Battery supply to OBDII connector.
F2	Cartridge	20A	Blue	Accessory socket.
F3	Cartridge	20A	Blue	Ignition switch.
F4	Cartridge	20A	Blue	Left-hand rear window raise/lower.
F5	Cartridge	20A	Blue	Driver's window raise/lower.
F6	Cartridge	20A	Blue	Front passenger's window raise/lower.
F7	Cartridge	20A	Blue	Right-hand rear window raise/lower.
F8				Not used.
F9				Not used.
F10	Cartridge	30A	Pink	Fan motor.
F11	Cartridge	30A	Pink	Passenger seat.
F12	Cartridge	30A	Pink	Switch system power 1 relay.
F13	Cartridge	30A	Pink	Switch system power 2 relay.
F14	Cartridge	30A	Pink	Switch system power 3 relay.
F15	Cartridge	30A	Pink	Driver's seat.
F16				Not used.
F17				Not used.

6-30 Roadside emergency

Fuse No	Fuse Type	Rating (amps)	Colour	Circuit
F18	Cartridge	30A	Pink	Driver's seat.
F19	Cartridge	30A	Pink	Passenger's seat.
F20	Cartridge	30A	Pink	Switch system power 4 relay.
F21	Cartridge	30A	Pink	Heated rear window, door mirrors.
F22				Not used.
F23	Cartridge	30A	Pink	Fuel pumps.
D1	Diode			Fuel pump relay.
D2				Not used.
F24				Not used.
F25				Not used.
F26	Mini	15A	Blue	Adaptive damping.
F27				Not used.
F28	Mini	30A	Green	Remote audio power amplifier.
F29	Mini	10A	Red	Telephone, CD autochanger, Navigation, Voice, VICS (Japan only).
F30	Mini	5A	Brown	Alternator sense (V8 S/C only).
F31	Mini	20A	Yellow	Sunroof control module.
F32	Mini	10A	Red	Driver's seat.
F33	Mini	5A	Brown	Transit relay.

Fuse No	Fuse Type	Rating (amps)	Colour	Circuit
F34	Mini	15A	Blue	Left/right-hand heater seat module.
F35	Mini	30A	Green	Electric parkbrake.
F36				Not used.
F37	Mini	10A	Red	Passenger seat.
F38				Not used.
F39				Not used.
F40				Not used.
F41				Not used.
F42	Mini	5A	Brown	Driver/passenger heated door mirrors.
F43				Not used.
F44	Mini	10A	Red	Left-hand rear reverse lamp, rear fog lamp, direction indicator, side marker, trailer tow relay and module.
F45				Not used.
F46	Mini	10A	Red	Luggage compartment lid and interior lamps, fuel filler flap solenoid.
F47	Mini	15A	Blue	Rear electronic module, fuel pump driver.
F48	Mini	10A	Red	Right-hand rear reverse lamp, fog lamp, direction indicator, side marker, number plate lamp.
F49	Mini	15A	Blue	Secondary fuel pump module (S/C only).
F50	Mini	5A	Brown	Transit relay.

6-32 Roadside emergency

Fuse No	Fuse Type	Rating (amps)	Colour	Circuit
F51	Mini	5A	Brown	ACC.
F52	Mini	5A	Brown	Electric parkbrake.
F53	Mini	10A	Red	Right-hand rear stop and tail lamps, high mounted stop lamp.
F54				Not used.
F55	Mini	10A	Red	Door lamps, roof courtesy lamps, map lamp, visor lamp, puddle lamp, glovebox lamp, garage door opener.
F56				Not used.
F57	Mini	10A	Red	Left-hand rear stop and tail lamps.
F58				Not used.
F59	Mini	15A	Blue	Rear electronic module, rear and passenger door locks, boot solenoid, steering column lock.

Luggage compartment fuse box – relays

Relay No	Type	Rating (amps)	Circuit
R1	ISO	40A	Heated rear window.
R2	ISO	40A	Switch system power relay 1.
R3			Not used.
R4	ISO	40A	Switch system power relay 3.
R5	ISO	40A	Switch system power relay 4.
R6			Not used.
R7	ISO	70A	Fan motor.
R8	MICRO	20A	Fuel release.
R9			Not used.
R10	ISO	40A	Accessory.
R11	ISO	40A	Switch system power relay 2.
R12			Not used.
R13			Not used.
R14			Not used.
R15	ISO	40A	Fuel pump.

6-34 Roadside emergency

Fire extinguisher

Many countries make it compulsory to carry a fire extinguisher. Your Jaguar Dealer can supply and fit one.

Mexican vehicles have a factory fitted fire extinguisher which contains 2.2 lbs (1 kg) of BC powder pressurised with nitrogen to a working pressure of 180 psi (12 bar) at 68°F (20°C).

This extinguisher can be used on liquid fires, electrical equipment fires and, if no explosion risk, gaseous fires.



WARNING:

Do not test the fire extinguisher prior to use. Partial discharge will render the extinguisher inoperative.

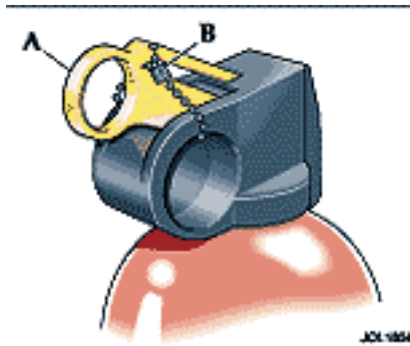

To operate the fire extinguisher

1. Unclip and remove the extinguisher from the bracket.
2. Put your finger through the yellow safety wedge ring (A) and pull hard to remove the wedge. The operating lever will be exposed.
3. Hold the extinguisher upright and aim at the base of the fire.
4. Press the lever down firmly.
5. Release the lever to stop the flow of powder.

Maintenance

Every six months:

- Remove the extinguisher from its bracket and check that the nozzle is clear.
- Check that the safety wedge strap (B) is secure.
- Check the pressure gauge on the base of the extinguisher. If the gauge is in the red area report it to your Jaguar Dealer immediately as the extinguisher may not work in an emergency.

General maintenance

Precautions

- Ensure that the vehicle is securely supported before working underneath it. Chock a front wheel and apply the parkbrake.
- Whenever possible use a suitable wheel-free lift when working beneath the vehicle. If a jack is used to support the vehicle, use axle stands carefully placed at the jacking points to provide a rigid support. Only use jacking equipment at the designed lifting points.
- Ensure that adequate ventilation is provided when volatile degreasing agents are being used.
- Never use volatile cleaning fluids under a vehicle standing over a pit. Many such fluids give off vapours which are heavier than air and dangerous to inhale.
- Wear protective overalls, ensure loose clothing (ties, etc.) are removed or covered when working adjacent to moving components (fan belts, etc.).
- Do not leave opened containers of oil, fuel, etc., about the work area. Always refit caps/seals to partially used containers when storing them for later use.
- Do not leave tools, equipment, spilt oil, etc., around or on the work area.
- Place a fire extinguisher close to the vehicle and disconnect the negative battery terminal.
- Do not use a naked flame to provide illumination, especially under the vehicle, or in the engine and luggage compartments. Do not smoke while working on the vehicle.
- Do not apply heat in an attempt to free nuts or fittings. This will damage protective coatings and there is a risk of damage to electronic equipment and brake and fuel lines from conducted heat.
- Inspect power leads of any mains electrical equipment for damage, and check that it is properly earthed.

7-2 Maintenance

General precautions against damage

- When working in the engine compartment protect the exterior paintwork by using suitable covers over the wings and scuttle.
- To prevent soiling the interior, carry out jobs requiring access to the passenger or luggage compartments first. If a job involves access to the interior in the course of other work, prevent the transfer of oil and grease to the interior by using seat and carpet covers and wearing clean overalls and gloves. If protective seat covers have been used they must be removed before the vehicle is driven on the public highway to ensure that, if needed, the side airbags can properly deploy.
- Always use a recommended service tool, where specified.
- Avoid spilling hydraulic fluid or battery acid on paintwork. Wash off with water immediately if this occurs.

Battery/ignition isolator switches

Non-approved battery isolator switches, which disconnect the power supply to all electrical circuits, are not recommended.

Used Engine Oil



WARNING:
Prolonged and repeated contact may cause serious skin disorders, including dermatitis and cancer.

Always use a hand cream to protect the skin from oil contamination. Avoid contact with the skin as far as possible and wash thoroughly after any contact. Keep oils out of reach of children.

PROTECT THE ENVIRONMENT: It is illegal to pollute drains, watercourses and soil. Use authorised waste collection facilities, including civic amenity sites and garages providing facilities for the disposal of used oil, oil filters and batteries. If in doubt, contact your Local Authority for advice on disposal.

Engine and throttle settings

Do not attempt to make adjustments to the engine or throttle settings. Many vehicle systems are controlled by complex electronic devices and require specialist knowledge. Such work should be entrusted to a Jaguar Dealer.

Hydraulic fluid

The brake hydraulic fluid in the master cylinder and brake operating system uses non-mineral polyglycol based brake fluid with a minimum standard of JAGUAR SUPER DOT 4. ONLY FLUID OF THIS TYPE AND STANDARD MAY BE USED.



WARNING:
Contamination of the brake system fluid by as little as 1 per cent will cause rapid deterioration of the system seals. Ensure that the brake fluid reservoir cap is securely fitted.

Hood release



WARNING:

Take care to keep away from rotating components if the engine is running when you open the hood.

Release the hood lock by pulling the lever below the fascia on the driver's side of the vehicle.

Lift the hood slightly and pull up the safety catch under the hood, located to the right of the grille. The gas filled struts will assist raising the hood, and retain it in the fully open position.



WARNING:

Before closing the hood ensure that no one is obstructing the closing area and that hands and clothes are clear. Remove tools, cleaning cloths, etc., from the engine compartment.

Close the hood to within a distance of 10 to 12 inches (250 to 300 mm) of the fully closed position, then let go to allow the hood to shut. Check by pulling the hood that both the right-hand and left-hand latches are engaged.

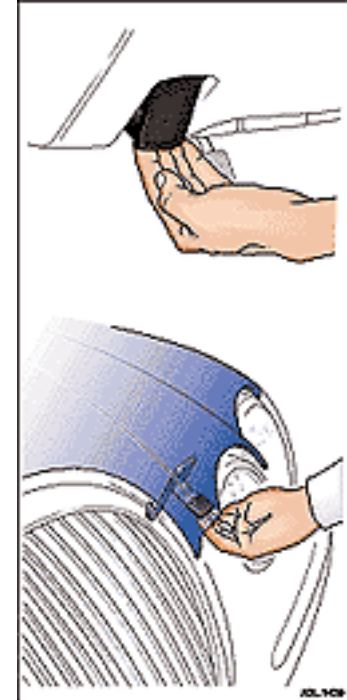

7-4 Maintenance

Regular checks

In the interests of safety and reliability, it is advisable to carry out the following checks at the recommended intervals, and always before starting on a long journey.

Daily

Check that there is sufficient fuel for the journey intended, particularly at night and before entering motorways.

Weekly

Tyres – Check the tyres, including the spare, for condition and pressure. Tyre pressures are given in Section 8.

Lights – Check that all exterior lights and direction indicators function correctly and that the lenses are clean.

Engine oil – With the vehicle standing on level ground, check the oil level and top up if necessary with oil of the correct grade.

Engine coolant – With the engine cold, check the level of the coolant in the coolant reservoir header tank. Any loss of fluid must be checked by a Jaguar Dealer.

Brake/clutch fluid – Check the level of the fluid in the brake fluid reservoir. Top up if necessary with new, unused Jaguar approved brake fluid.

The reservoir is initially nearly full, but the level will drop as the brake pads wear. If the level appears unusually low, location of the fluid leakage must be checked by a Jaguar Dealer.

Power steering fluid – With the engine cold check the level of the fluid in the power steering fluid reservoir. Top up if necessary with fluid of the correct specification. Any loss of fluid should be checked by a Jaguar Dealer.

Monthly

Windscreen washer fluid – Top up with recommended windscreen washer fluid and clean soft water. Check the operation of the washer. Use Jaguar Windscreen Washer Fluid to keep the glass clean and also to prevent the fluid from freezing during cold weather.

Wiper blades – Check the quality of the wipe. If smearing or juddering is evident, clean the windscreen and renew the wiper blades.

Reservoir and dipstick locations V6 engine

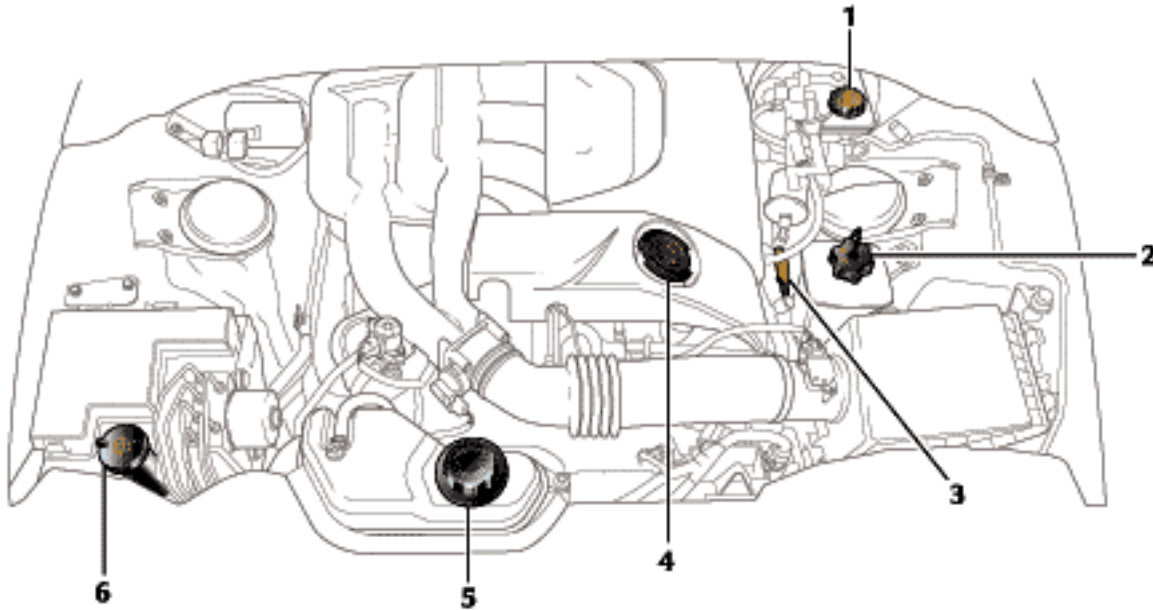

- 1. Brake/clutch reservoir
- 2. Power steering reservoir
- 3. Engine oil dipstick

- 4. Engine oil filler
- 5. Coolant reservoir
- 6. Windscreen wash reservoir

7-6 Maintenance

Reservoir and dipstick locations V8 engine

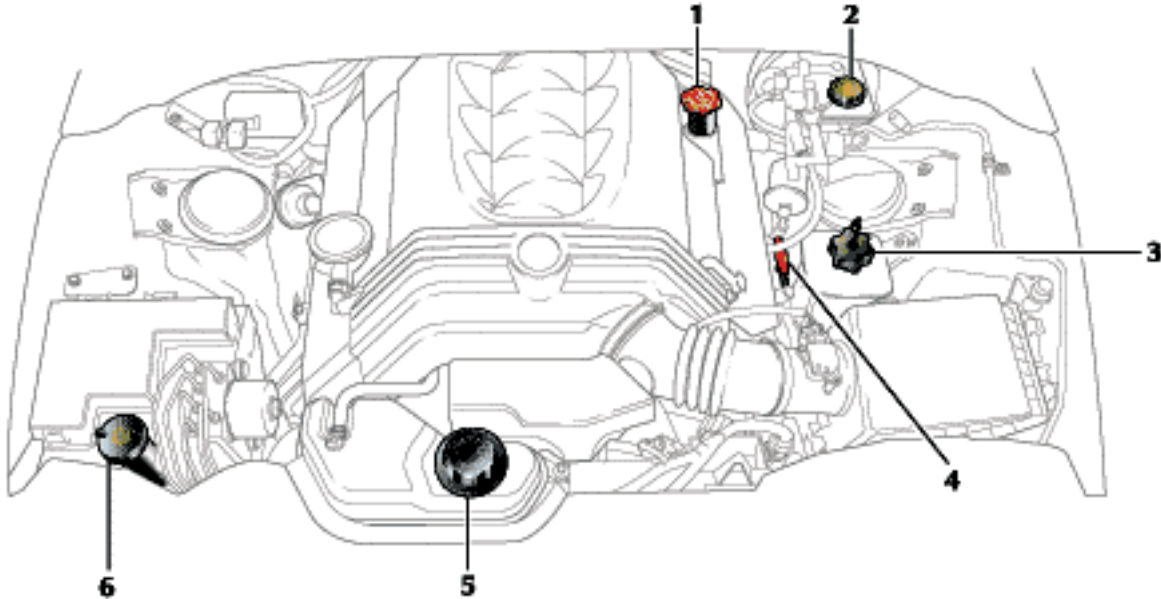

1. Engine oil filler

2. Brake/clutch reservoir

3. Power steering reservoir

4. Engine oil dipstick

5. Coolant reservoir

6. Windscreen wash reservoir

Checking and top up

Check engine oil level

Check the oil level regularly with the vehicle on flat, level ground.

Refer to page 7-5 or page 7-6 for dipstick and oil filler locations.

It is preferable to check the oil level after the vehicle has been standing, that is, with the engine completely cold.

If the engine has been started do not check the oil level until the engine has reached normal operating temperature. Stop the engine and wait for a minimum of 5 minutes to allow the oil to drain back into the sump.

Remove the dipstick (A) and wipe clean with a non-fluffy cloth. Replace fully, then withdraw the dipstick. If the oil level is above the lower of the two dots on the dipstick then no additional oil is required.

If the oil level reaches the lower of the two dots, remove the oil filler cap (B) and add oil, to the quantity and specification shown on the next page.

Refit the filler cap and hand tighten securely.

Caution: Do not use oil additives of any type. Use only specified lubricants. Note that Jaguar does not approve the use of synthetic engine oil in the V6 engine.

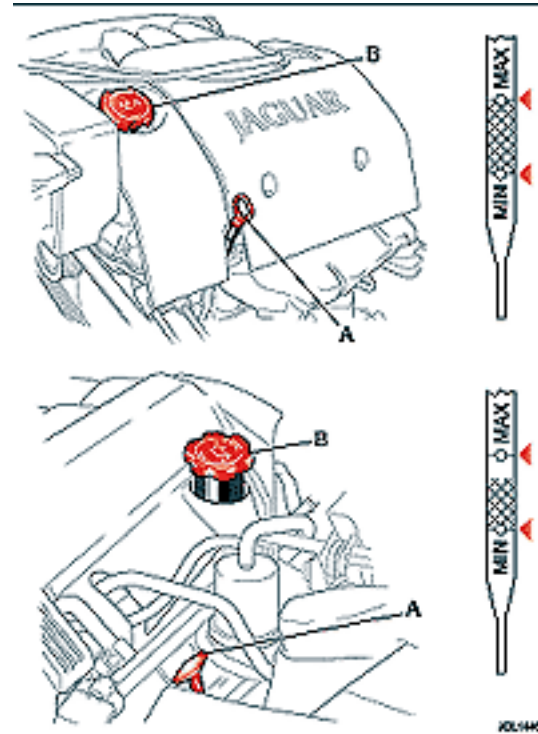

7-8 Maintenance

Recommended engine oil

When the oil level is at the lower dipstick mark, add 1 quart (1 litre) of oil.

Oil specification – API SJ / EC and ILSAC GF3.

When topping up between oil changes, make sure that you use oil that has the correct quality level (API service) and viscosity grade. Your vehicle's warranty may be invalidated if damage is caused by use of improper engine oil.

Note: Jaguar does not approve the use of synthetic engine oil in the V6 engine.

SAE Viscosity Rating

It is recommended that you use only approved engine oils to meet the SAE viscosity range/ambient temperature scale shown below. For maximum fuel economy, 5W/30 oil is recommended.

Recommended SAE Viscosity Range/Ambient Temperature Scale:

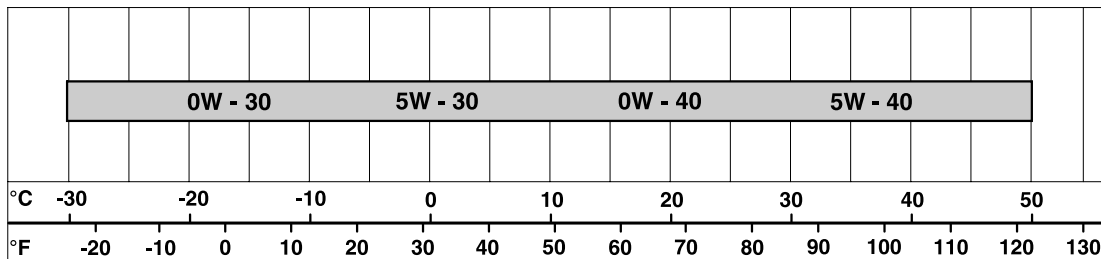



Check power steering fluid level

Caution: It is imperative that the power steering system does not become contaminated in any way. Always dispense fluid from a fresh sealed container and clean the area around the reservoir neck both before and after topping up. Never return drained fluid to the system.

Refer to page 7-5 or page 7-6 for power steering fluid reservoir location.

Check the fluid level when the engine is 'COLD' and the vehicle is on a flat, level surface.

Wipe clean and remove the filler cap from the reservoir; take great care to prevent any foreign matter from entering.

Check that the fluid level is between the marks on the dipstick.

If necessary, top up with power steering fluid as specified by your Jaguar Dealer.

DO NOT OVERFILL.

Refit the filler cap.

Should the level be very low, report the loss of fluid to the nearest Jaguar Dealer.

7-10 Maintenance

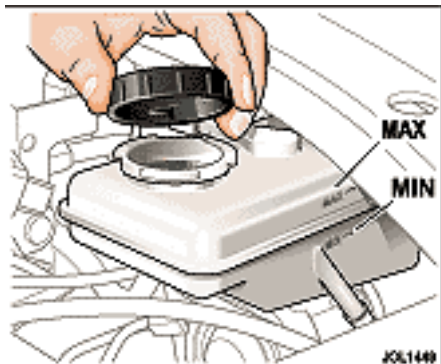

Check brake/clutch fluid reservoir

The manual transmission clutch fluid is shared with the brake fluid in a common reservoir. Refer to page 7-5 or page 7-6 for brake/clutch fluid reservoir location.

Caution:

1. While handling brake fluid, take extreme care; brake fluid must not contact the vehicle paintwork.
2. Always use fresh, clean fluid from a new container. Never introduce used brake fluid into the system.

The fluid is visible through the translucent casing of the reservoir and must be maintained at the 'MAX' mark.



WARNING:

The fluid level will drop as the brake pads wear. If the level is very low report the loss of fluid to the nearest Jaguar Dealer. Do not drive the vehicle until the cause is rectified.

If necessary, top up as follows.

Before removing the cap, clean the reservoir and cap thoroughly with a non-fluffy cloth to ensure that no foreign matter enters the reservoir.

Unscrew the filler cap and top up to the 'MAX' level using brake fluid to specification **Jaguar Super DOT 4 (ESA-M6C25-A)**.

Refit the filler cap securely.

To avoid contamination should any brake fluid be spilled, replace the cap on the reservoir before cleaning the spilled fluid from the vehicle.

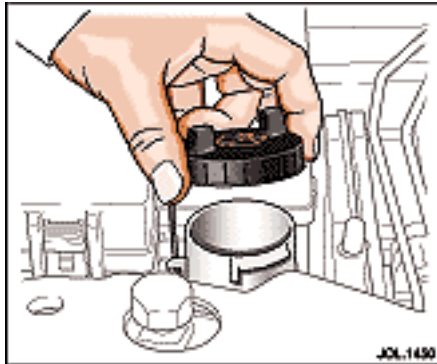

Check windscreen/headlamp washer reservoir

Refer to page 7-5 or page 7-6 for windscreen washer reservoir location.

The washer reservoir contains the fluid for the windscreen washers and the headlamp powerwash system (where fitted).

Fill to just below the neck with Jaguar Windscreen Washer Fluid diluted with clean, preferably soft water as specified in the instructions on the bottle.

Do not over-fill.

Note: Using a non-approved fluid may adversely affect the wiper blade rubber, resulting in ineffectual and noisy wiping.

Cold weather precautions

To prevent damage to the pump during freezing conditions, use Jaguar Windscreen Washer Fluid at the strength shown on the bottle, for the anticipated ambient temperature.



WARNING:

Windscreen washer fluid is toxic and in concentrated form is flammable. Be sure to observe all warnings indicated on the washer solution container.

Under no circumstances must cooling system antifreeze be used, since this will damage the paintwork.

7-12 Maintenance



WARNING:
Do not remove the coolant header tank filler/pressure cap while the engine is hot. If the cap must be removed, protect the hands against escaping steam and slowly turn the cap anti-clockwise until the steam pressure starts to escape. Leave the cap in this position until the pressure is released, and then remove the cap completely.

Topping up



WARNING:
Do not allow antifreeze to make contact with skin or eyes. If this should happen, rinse the affected area immediately with plenty of water.

Caution: Antifreeze will damage paintwork. Avoid spillage.

Top up with a mixture of 50% water and 50% antifreeze until the coolant is between the MAX and MIN indicators inside the header tank. Use anti-freeze to specification WSS M97B44, coloured orange, Extended Life Coolant.

Refit the filler cap and hand-tighten securely until the ratchet operates.

Engine anti-freeze

When used at the correct concentration, antifreeze not only protects the engine from frost damage in winter, it also provides all year round protection against internal corrosion.

The cooling system should always be topped up or refilled with the specified anti-freeze at the correct concentration.

This 50/50% mixture gives frost protection for temperatures down to -40°F (-40°C).

Do not mix any other anti-freeze with that specified; inferior quality anti-freeze may be ineffective in maintaining adequate frost and corrosion protection to the cooling system.

The coolant solution may remain in the cooling system for five years or 156,000 miles (250,000 km) after which the system should be drained, flushed and refilled.

Engine block heater

For further information consult your Jaguar Dealer.

Caution: The fitting of an engine block heater does not eliminate the need for antifreeze under freezing conditions.

Check coolant level

Refer to page 7-5 or page 7-6 for coolant header tank location.

The coolant level MAX and MIN indicators are located inside the reservoir and are only visible when looking into the filler neck with the cap removed. Check the level only when the engine is cold.

The coolant level should be between the MAX and MIN indicators. If persistent coolant loss is noticed, have a Jaguar Dealer investigate the cause immediately.

Capacities

US Quarts Litres

Engine oil:

- V6 engines, including oil filter 6.9 6.5
- V8 engines, including oil filter 6.9 6.5

The rear axle (final drive unit) and automatic transmission unit (gearbox) will not normally require to be checked or topped up. For information regarding manual transmission servicing, please refer to your Dealer.

Cooling system, including reservoir and climate control:

- V6 engines 11.0 10.4
- V8 engines 10.5 10.0

Windscreen washer reservoir:

- Without headlamp power wash 4.6 4.4
- With headlamp power wash 7.0 6.6

US Gallons Litres

Fuel tank capacity 18.3 69.5

7-14 Maintenance

Battery

A low maintenance battery specifically designed for use with this vehicle is fitted below the luggage compartment floor panel.



WARNING:

- 1. The cell plugs and vent pipe must be in place at all times when the battery is in the vehicle. Failure to fit, or incorrect fitting of these items is potentially hazardous.**
- 2. To avoid injury do not use an open flame or cause an electric spark when checking the battery. Hydrogen gas generated by the battery is flammable and may explode.**
- 3. Do not connect any 12 volt equipment, (for example a 12 volt lead lamp), directly to the battery terminals. Use the cigar lighter sockets to temporarily connect Jaguar approved accessories.**
- 4. Do not let battery acid electrolyte come into contact with skin or eyes. If you get any in your eyes or on your skin, immediately rinse with cold water and consult a doctor.**

Caution:

- 1. Switch off the ignition before disconnecting battery terminals. Always disconnect the earth terminal first and reconnect last.**
- 2. Do not let battery acid come into contact with painted surfaces or fabric.**

The exterior of the battery should be occasionally wiped clean to remove any dirt or grease.

If a new battery is to be fitted, it must be the same type as the original.

The use of unapproved batteries is not recommended and could invalidate the vehicle warranty.

Note: The service life of the battery is dependent on its condition of charge. It must always be sufficiently charged for the battery to last an optimum length of time.

We recommend that the battery charge is checked frequently if the vehicle is used mostly for short distance trips, or if it is not used for long periods of time.

Alternator

To prevent damage to the alternator, do not run the engine while the battery or any of the charging circuit cables are disconnected.

The alternator has polarity-sensitive components that may be irreparably damaged if subjected to incorrect polarity. Ensure that the battery earth lead is always connected to the battery negative terminal.

Check/top up battery electrolyte

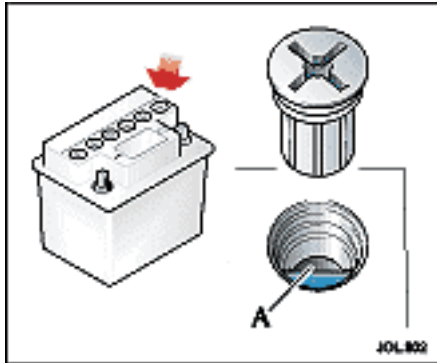

In normal climates this must be carried out at least once a year. In hot weather/ climates the electrolyte level must be checked at least every three months.

Fold the luggage compartment floor panel forwards.

Unscrew the six cell plugs. Check that the electrolyte is level with the plastic level indicator (A). If necessary, top up with distilled water but do not overfill.

If illumination is required, use a hand-held flashlight to inspect the electrolyte level.

Refit the six cell plugs and refit the battery cover.

Battery charging



WARNING:
Batteries produce combustible gas (hydrogen) when being charged. The battery must be removed from the vehicle before charging commences.

To disconnect the battery, refer to **Battery lead disconnection** on the next page.

When charging the battery ensure that the charge voltage is the same as the nominal voltage of the battery.

Switch off the charger before connecting or disconnecting terminal connections to avoid sparks and short circuits.

Ensure that the charger positive (+) lead is connected to the positive (+) terminal of the battery and the negative (-) lead is connected to the negative (-) terminal of the battery.

Do not remove or loosen any of the cell plugs when charging the battery.

Check and, if necessary, top up the electrolyte level when the battery is fully charged.

7-16 Maintenance

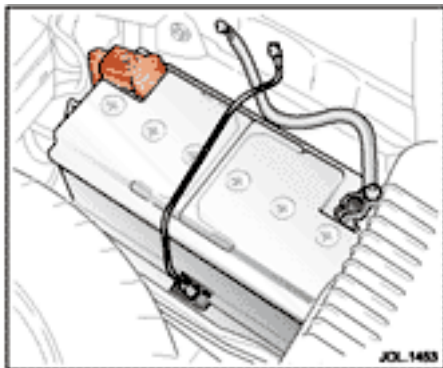

Battery lead disconnection



WARNING:

California Proposition 65:
Battery posts, terminals and related accessories, contain lead and lead compounds. Wash hands after handling.

Caution:

1. Under no circumstances should a battery be disconnected whilst the ignition circuit is live, as permanent damage to the instrument cluster may occur.
2. Disconnect the negative lead (earth terminal) first.

Fold the luggage compartment floor panel forwards.

Slacken the negative lead pinch bolt and disconnect the negative (-) battery lead.

Slacken the positive lead pinch bolt and disconnect the positive (+) battery lead.

Clean the battery posts and coat the post bases with petroleum jelly.

Battery lead connection

Note: Upon battery reconnection the security system will be armed. Opening any protected entry will sound the alarm. Make sure that a key or key transmitter is available.

Caution: Do not overtighten the pinch bolts.

Connect the positive (+) lead, tighten the pinch bolt and clip the positive terminal cover on the battery. Connect the negative (-) lead and tighten the pinch bolt.

After the battery has been reconnected and the ignition switch is turned to position 'II', the message centre display, if fitted, will initially show an erroneous reading i.e. - - - - -. This will remain until after the bulb check sequence, when the correct recorded mileage will be displayed. This is a normal function of the instrument cluster.

After battery reconnection

After reconnecting the battery:

- Reset the electric parkbrake; see Section 4.
- Reset the electrically operated windows anti-trap function; see Section 3.
- The trip computer will lose all recorded trip data and all trip functions will be reset to zero. The vehicle total odometer reading is retained.
- The radio will not operate until the correct security code has been re-entered. Refer to the Audio System Handbook.
- If the battery is disconnected for more than 72 hours the radio preset channels will need to be reset.
- Reset the clock to the correct time.

The engine electronic control system automatically adapts to certain characteristics of the vehicle. When the battery is disconnected, these adaptations are lost.

On reconnection, therefore, some slightly abnormal drive symptoms may occur and the vehicle may need to be driven 10 miles (16 kilometres) or more while the control system re-adapts.

Windscreen wipers

The wiper blades are renewed at every service interval.

Use Jaguar Screen Clean Paste to remove contamination from the windscreen to ensure effective wiping or if smearing or juddering becomes evident. A more aggressive cleaning agent may be required to remove stubborn contamination. Contact a Jaguar Dealer for advice.

To ensure that the windscreen remains smear free, the washer system should be operated whenever the wiper is used, even when it is raining.

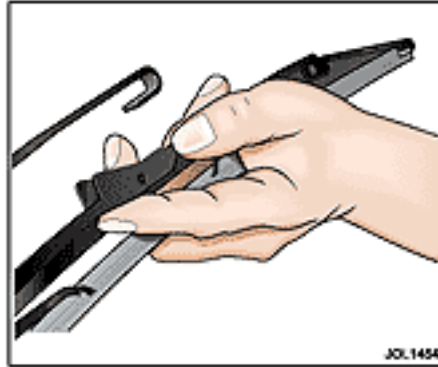

Windscreen wiper blades – inspect and clean

Lift the wiper blades clear of the windscreen and wipe the blades with a clean, soft cloth moistened with water to which a mild liquid detergent has been added.

Inspect the wiper blades, and if there any signs of wear or damage; renew the blades.

Renew the wiper blades before and after each winter, or more often if required.

Wiper blade renewal

Move the wiper arm away from the windscreen, squeeze the retaining clip and withdraw the wiper blade from the arm. After fitting the new blade, check that it is held firmly in position. Reposition the wiper arm and blade onto the screen.

Windscreen washers

Two windscreen washer nozzles are mounted on the hood. Each nozzle directs two spray patterns to the windscreen.

Note: The windscreen wiper jets and headlamp washer jets are not adjustable.

7-18 Maintenance

Tyres

Tyres of the correct type, manufacturer and dimensions, with correct cold inflation pressures are an integral part of every vehicle's design. Regular maintenance of tyres contributes not only to safety, but to the designed function of the vehicle. Road-holding, steering and braking are especially vulnerable to incorrectly pressurised, badly fitted or worn tyres.

Tyres of the correct size and type, but of different make have widely varying characteristics. It is therefore recommended that Jaguar approved tyres are fitted to all wheels.

A tyre recommendation placard is placed on the inside of the fuel filler flap, giving information specific to the vehicle's wheel and tyre equipment.

Always ensure that the wheel nuts are fully seated before finally tightening the nuts in alternate sequence.

Tyre renewal

When renewing tyres, it is preferable to fit a complete vehicle set. If either front or rear tyres only need to be renewed, new tyres must be fitted, as axle sets, to replace worn ones.

After new tyres have been fitted the wheels need to be dynamically balanced.

The radial ply tyres specified are designed to meet the high-speed performance capability of this vehicle (see Section 8).

Do not fit tyres with a different tread pattern, size or speed rating.

Tyre pressures

The tyre pressures recommended (see Section 8) provide optimum ride and handling characteristics for all normal operating conditions. The pressures should be checked, and correctly set each week with the tyres cold.

Tyre temperatures and pressures increase when running. Deflating a warm tyre to the recommended pressure will result in under inflation which may be dangerous.

A slight natural pressure loss occurs with time. If this exceeds 2 lbf/in² (14 kPa, 0.14 bar, 0.14 kg/cm²) per week, the cause should be investigated and rectified.

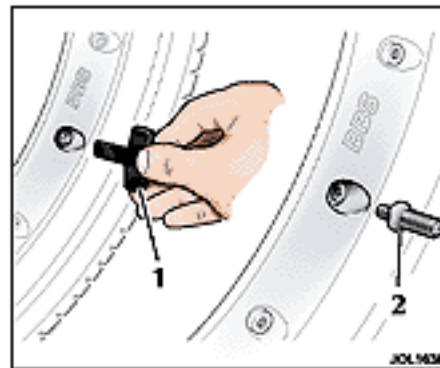

'R' performance wheels – These wheels have a slotted screw valve cover on the wheel face. A pouch containing a 'T'-shaped screwdriver and a valve adaptor, for use with these wheels, is stowed in the glove compartment.

To access the valve, remove the slotted screw valve cover using the screwdriver (1). Screw in the adapter (2) and hand-tighten. After checking the pressure, remove the adapter and refit the valve cover.

Note: It is an offence in certain countries to drive a vehicle with tyres that are not inflated in accordance with the vehicle's proper use.

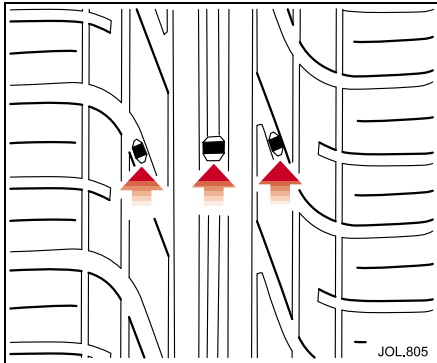

Wear

All tyres fitted as original equipment include tread wear indicators (TWI) in their tread pattern. When the tread has worn to a remaining depth of 1.6 mm the indicators appear at the surface as bars which connect the tread pattern across the full width of the tyre.

It is illegal, in certain countries, to continue to use tyres after the tread has worn to less than 1.6 mm over three quarters of the width and the entire circumference of the tyre.

It should be noted that the properties of many tyres alter progressively with wear. In particular the 'wet grip' and aquaplaning resistance are gradually but substantially reduced. Extra care and speed restriction should therefore be exercised on wet roads as the effective tread depth diminishes.

Incorrect wheel alignment will accelerate tyre wear. Fins on the inner or outer edges of the tread pattern are caused by excessive toe-in or toe-out respectively. As fins may also be caused by high cornering speeds or road camber, it is advantageous to have the cause detected by having the wheel alignment checked.

Tyre repair

It is recommended that damaged tyres are discarded and new tyres fitted. They must not be repaired in view of the high performance capability of the vehicle.

Damage

Excessive local distortion can cause the casing of a tyre to fracture and may lead to premature failure. Tyres should be examined especially for cracked walls, exposed cords, etc. Flints and other sharp objects must be removed from the tyre tread; if left in they may work through the cover. Clean off any oil or grease contamination by using a suitable cleaner.

Caution: Do not use paraffin (kerosene), because this has a detrimental effect on rubber.

Tyre use after vehicle storage

After a long period of a vehicle standing, tyres may become locally distorted with a flat area. This will cause an uneven ride for a few miles until the tyres have warmed up and the 'flat' rounds off.

However, to reduce the effects of flat-spots, the tyres of a stored vehicle may be inflated to pressures not exceeding 50 lbf/in² (343 kPa, 3.4 bar, 3.5 kg/cm²).

7-20 Maintenance

Winter (snow) tyres

The tyres fitted as original equipment are designed with a rubber compound, tread pattern and width specially suited for high speeds in normal road conditions, but they are less suitable during extremes of low temperatures, snow and ice.

The use of winter tyres will considerably improve the vehicle's handling during these conditions.

It is recommended that only Jaguar approved winter tyres are used, as follows:

Winter 16 inch wheels

Pirelli Winter 210 225/55R16 95H
Continental TS770 and TS790

Winter 17 inch wheels

Pirelli Winter 210 235/50R 17 100H

Tyre directional indicators must be rotating in a clockwise direction when viewed from the right-hand side of the vehicle, and anti-clockwise when viewed from the left-hand side of the vehicle.

Do not exceed 130 mph (210 km/h) when using Jaguar approved winter tyres.

Winter tyres must be used in vehicle sets, that is, fitted on all four wheels.

If non-Jaguar approved winter tyres are fitted, refer to the tyre pressure information in Section 8.

Snow chains

Snow chains, of the recommended type, may only be fitted to rear wheels.

Caution: Snow chains must not be fitted to wheels of 17 inch diameter or above.

Contact your Jaguar Dealer for details and availability of approved snow chains.

The maximum speed when using snow chains is 30 mph (48 km/h).

Remove the snow chains immediately the roads are clear of snow.

Ensure the fitting instructions supplied with the snow chains are kept in a safe place, for example, with this literature pack.

Note: Traction control or (if fitted) Dynamic Stability Control, **MUST** be switched **OFF** when using snow chains.

Vehicle care

Valet kit

A valet kit containing a selection of Car Care products is available from the Jaguar accessory range.

Interior care

Brush and clean the interior regularly. Use a vacuum cleaner where possible to remove all dust from the interior and trim.

Carpets

Marks or stains can be removed by gentle scrubbing with a weak solution of soap and warm water.

For more stubborn stains a commercially available carpet cleaner should be used. See your Jaguar Dealer for advice.

Headlining

Remove dust in the headlining with a vacuum cleaner. To remove stains, dab gently without pressing, using a fluff-free white cloth, moistened with Jaguar Upholstery Cleaner.

Do not use methylated spirit or solvents as this may cause damage or discoloration to the headlining.

Leather upholstery

Dust and dirt can penetrate the pores and creases of leather, causing surface wear and brittleness. To prevent ingrained dirt, inspect the seat upholstery regularly and clean every one to two months as follows:

- Wipe the seat surfaces with a clean, damp, non-coloured cloth, changing frequently to a clean area of cloth. Avoid over-wetting.
- If this is not sufficient, use a cloth which has been dampened with warm soapy water and then wrung out; avoid over-wetting. Use only mild non-caustic soap.
- Use Jaguar Leather Cleaner for heavily soiled areas.
- Dry off and rub with a clean soft cloth, changing surfaces regularly.

When staining (e.g. from clothing) or spillages occur, clean the affected area immediately as described above.

Note: Do not use solvents such as petrol (gasoline), white spirit or alcohol. Do not use detergents, furniture polish or household cleaners. Although such treatments may give, initially, an impressive appearance, their use will lead to rapid damage or deterioration of the leather, and will not be covered by the Manufacturer's Warranty. Unless spillages

such as tea, coffee or ink are washed away immediately, permanent staining may have to be accepted.

If a valeting service is used, ensure that the specialist firm concerned are aware of, and follow these instructions precisely.

Cloth upholstery

Weekly light vacuuming can extend the life of the fabric.

Using Jaguar Upholstery Cleaner, following the instructions, will preserve and enhance cloth upholstery. Test the upholstery cleaner solution on an unseen part of the seat. Do not over wet.

Caution:

1. **Never use soap, ammonia, bleach or other cleaners intended for use on hard surfaces.**
2. **Do not use upholstery cleaner on electrical equipment such as fascia switches.**
3. **When cleaning around electrical equipment such as switches, ensure that fluids do not leak into any gaps around the components or between panels or trim.**

7-22 Maintenance

Removing stains

Most stains on woollen fabric can be removed if treatment is carried out immediately, before the stain has a chance to 'dry-in'.

Keep the necessary cleaning materials in a convenient place.

Most stains can be treated with one of three cleaning fluids: Jaguar Upholstery Cleaner, dry cleaning fluid or clean water.

Mop up excess liquid with absorbent tissue (preferably white) or absorbent cloth; scoop up dry solids. Work inwards from the edge of the stain to prevent spreading. Use small amounts of cleaning liquid, blotting between applications.

Work slowly and thoroughly using light pressure. If the stain cannot be removed, contact a reputable dry cleaners.



WARNING:

Dry Cleaning Fluids may be toxic or flammable. Take adequate precautions when handling these products.

Exterior care

Note: All the cleaning materials mentioned in this section are available from the Jaguar Accessory Range.

Washing

For best results, do not wash the vehicle under strong sunlight. Always allow the vehicle to cool down before washing.

Do not use a dry cloth to wipe dirty paintwork. Dust and gritty substances are abrasive and will scratch the paintwork. Remove dirt using a cellulose sponge and plenty of warm (never hot) water. Rinse off with clean water and dry using a clean, damp chamois leather.

Do not use household soaps or detergents. The use of Jaguar Vehicle Shampoo is recommended.

Do not direct hoses at full force around door and luggage compartment seals. Using high pressure water jets on the paintwork is not recommended.

Do not allow bird droppings or tree sap to harden. Remove from paintwork immediately with a lukewarm soap and water solution.

In winter, when salt is used on the roads, wash the vehicle frequently, and immediately after encountering such conditions. Clean undersides and wheel arches using a high pressure jet.

Automatic car wash

Note: Regular use of automatic car washes tends to dull the lustre of the paintwork.

After leaving the car wash, switch on the windscreen wiper immediately to remove water and prevent a build up of wax. Jaguar Screen Clean Paste can be used to clean any residual wax from the glass.

Removing grease or tar

Remove grease or tar with Jaguar Tar Remover or methylated spirit (alcohol). White spirit is also effective, but must not be applied to rubber, particularly the windscreen wiper blade.

Glass surfaces

To avoid scratching glass surfaces, do not clean dirty glass with dry paper or cloth. Use clean, warm water and a chamois leather which is reserved for glass only.

The following products will ensure glass surfaces and windscreen wipers are kept in good condition:

Jaguar Screen Clean Paste – Apply to the exterior of the windscreen only to ensure effective operation of the windscreen wiper.

Jaguar Glass Cleaner – Interior and exterior of all other glass surfaces.

Jaguar Screen Wash – Washer reservoir additive.

Jaguar Winter Care Kit comprising de-icer, ice scraper, anti-mist wipe cloth and aerial cleaner – for use in adverse weather conditions.

Note:

1. Renew the wiper blades when worn to prevent scratching. Clean the rubber wiper blades regularly with a mild detergent solution.
2. It is advisable to clean the windscreen with Jaguar Screen Clean Paste at regular intervals.

Cleaning the rear screen

To avoid damaging the heating and radio elements when cleaning the inside of the rear screen use only a soft damp cloth or chamois leather. Do not use solvents or sharp objects to clean the glass.

Polishing paintwork and chromium plating

For maximum protection against road dust, salts, industrial fall-out etc., it is recommended that the vehicle is polished regularly using Jaguar Polish, Chrome Polish and a Polishing Cloth.

Paint chips

Scratches and chips should be touched in before weathering action begins. Inspect the paintwork immediately after the vehicle has been washed.

Underhood cleaning

Underhood cleaning using high pressure hoses or steam cleaners should be done by a Jaguar Dealer. Indiscriminate use of cleaning equipment could damage or contaminate the electronic control modules and fuse boxes.

Care of alloy road wheels

The alloy road wheels are covered with a protective anti-corrosion coating. To prevent corrosion it is essential that this coating is not damaged.

When removing or fitting tyres always advise the tyre fitter to treat the alloy wheels with great care and to only use equipment with spigot or stud hole clamping. The equipment must not have any moving parts which contact the wheel, and tyre levers must not be used.

Wash the wheels with soap and water at two week intervals to avoid an accumulation of particles which could become embedded in the wheel surface. In salty conditions the wheels should be cleaned weekly.

In compliance with German Road Traffic Law the size of the wheel rims is stamped or cast on all wheels.

Electrical accessories



WARNING:

Alterations to the electrical system, including the fitting of accessories not designed for this Jaguar, will cause damage to the electrical circuits and systems. In some circumstances this could result in a malfunction or fire. All accessory work should be entrusted to a Jaguar Dealer.

The cigar lighter sockets can be used for plug-in accessories which are only temporarily connected to the vehicle (for example, a car vacuum cleaner).

Caution:

1. Under no circumstances must the power supply be obtained directly from either battery terminal.
2. The use of non-approved accessories can reduce the battery capacity and charge period to an unacceptable level, therefore, Jaguar cannot accept any liability for the fitment of any such item.

Earth points

If an accessory needs to be connected to an earth point, consult a Jaguar Dealer.

Caution: Under no circumstances must holes be drilled in the bodywork to accept earth terminals.

Vehicle data

Engine	2.5 litre	3.0 litre	4.2 litre
Type	V6, dual overhead camshafts, 4 valves/cylinder	V6, dual overhead camshafts, 4 valves/cylinder	V8, dual overhead camshafts, 4 valves/cylinder
Capacity.	152 inch ³ (2497 cm ³)	181 inch ³ (2967 cm ³)	256 inch ³ (4196 cm ³)
Bore.	3.215 inch (81.65 mm)	3.504 inch (89.0 mm)	3.386 inch (86.0 mm)
Stroke	3.130 inch (79.5 mm)	3.130 inch (79.5 mm)	3.555 inch (90.3 mm)
Compression ratio	10.50:1	10.50:1	11.0:1 (normally aspirated) 9.1:1 (supercharged)

8-2 Specifications

Weights (average/approximate)

	Vehicles with V6 engines		Vehicles with V8 engines (normally aspirated)		Vehicles with V8 engines (supercharged)	
	lbs	kg	lbs	kg	lbs	kg
Kerb weight, (no options fitted)	3572	1620	3826	1735	3969	1800
Front axle kerb weight	1841	835	2029	920	2128	965
Rear axle kerb weight	1731	785	1797	815	1841	835
Gross vehicle weight (G.V.W.)	4806	2180	4839	2195	4938	2240
Gross front axle weight	2205	1000	2282	1035	2359	1070
Gross rear axle weight	2601	1180	2557	1160	2579	1170
Gross combination weight (except V6 2.5 litre manual)	8885	4030	8918	4045	9017	4090
Gross combination weight (V6 2.5 litre manual only)	8335	3780				

Note: Gross combination weight is the gross vehicle weight plus recommended trailer weight.

Roof-rack capacity and trailer weights

	lbs	kg
Roof-rack capacity including weight of rack	220	100
Maximum permitted luggage compartment load with four passengers and driver	132	60
 Trailer weight:		
Braked (except V6 2.5 litre manual)	4070	1850
Braked (V6 2.5 litre manual only)	3528	1600
Unbraked (maximum recommended)	1650	750
Trailer nose load	165	75

Note:

1. The roof-rack capacity shown above is included in the total vehicle carrying capacity, and the maximum permissible axle weights shown on the Vehicle Identification Plate must not be exceeded. In addition, the tyres must be inflated to the pressures given for speeds above 100 mph (160 km/h).
2. The maximum permitted luggage compartment load shown above can be exceeded provided that the requirements regarding the maximum permissible axle weights and tyres pressures in the Note above are followed.

8-4 Specifications

Wheels and tyres

Wheel size	Tyre size/manufacturer
7.5 x 16	225/55 R 16 95H Bridgestone Turanza EL42 All Season
7.5 x 17	235/50 R 17 96H Michelin Pilot HX MXM4 All Season
8 x 18 ('R' models – front)	245/40 ZR 18 Continental ContiSport Contact
9.5 x 18 ('R' models – rear)	275/35 ZR 18 Continental ContiSport Contact
8 x 18 (not 'R' models)	245/40 ZR 18 97Y Pirelli P-Zero
4.5 x 16	T145/80 R 16 105M Continental (Temporary-use spare wheel)
4 x 18	T115/85 R 18 96M Pirelli (Temporary-use spare wheel)

Tyre pressures

Tyre size		Speeds below 100 mph (160 km/h)	Speeds above 100 mph (160 km/h)
225/55 R 16 235/50 R 17	Front	28 lbf/in ² (190 kPa, 1.9 bar, 2.0 kg/cm ²)	34 lbf/in ² (240 kPa, 2.4 bar, 2.5 kg/cm ²)
	Rear	32 lbf/in ² (220 kPa, 2.2 bar, 2.3 kg/cm ²)	38 lbf/in ² (260 kPa, 2.6 bar, 2.7 kg/cm ²)
245/40 ZR 18 (not 'R' models)	Front	28 lbf/in ² (190 kPa, 1.9 bar, 2.0 kg/cm ²)	31 lbf/in ² (210 kPa, 2.1 bar, 2.2 kg/cm ²)
	Rear	32 lbf/in ² (220 kPa, 2.2 bar, 2.3 kg/cm ²)	35 lbf/in ² (240 kPa, 2.4 bar, 2.5 kg/cm ²)
245/40 ZR 18 ('R' models)	Front	28 lbf/in ² (190 kPa, 1.9 bar, 2.0 kg/cm ²)	36 lbf/in ² (250 kPa, 2.5 bar, 2.6 kg/cm ²)
275/35 ZR 18 ('R' models)	Rear	32 lbf/in ² (220 kPa, 2.2 bar, 2.3 kg/cm ²)	38 lbf/in ² (260 kPa, 2.6 bar, 2.7 kg/cm ²)
Temporary-use spare wheel		60 lbf/in ² (420 kPa, 4.2 bar, 4.3 kg/cm ²)	

8-6 Specifications

Tow-bar fixing points

The left and right-hand rear longitudinal members are factory pre-marked for drilling for tow-bar mountings. On each side, there are two upper drilling points (accessed from inside the luggage compartment) and two lower drilling points (accessed from the underside of the vehicle). The illustration shows the right-hand side upper and lower drilling points, indicated by arrows.

The left and right-hand rear tie-down brackets are fixed to the body by four bolts (A).

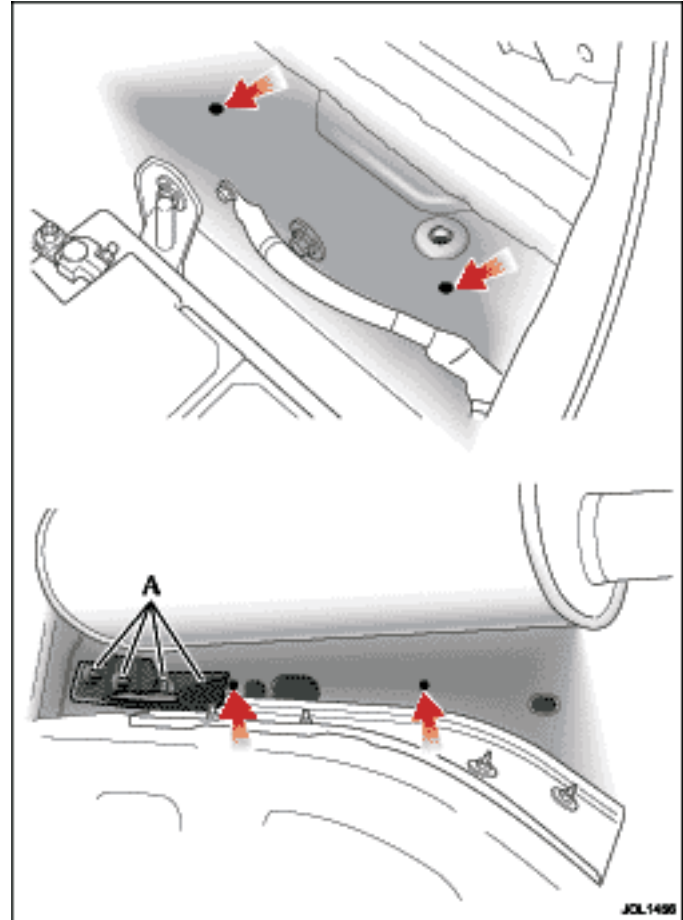

Tow-bar fixing points (continued)

Tow-ball centre height from the ground at Gross Vehicle Weight (GVW):

(B) = 14.57 to 15.04 inches (370 to 382 mm).

Tow-ball centre distance from centre-line of rear axle:

(C) = 46.06 inches (1170 mm).

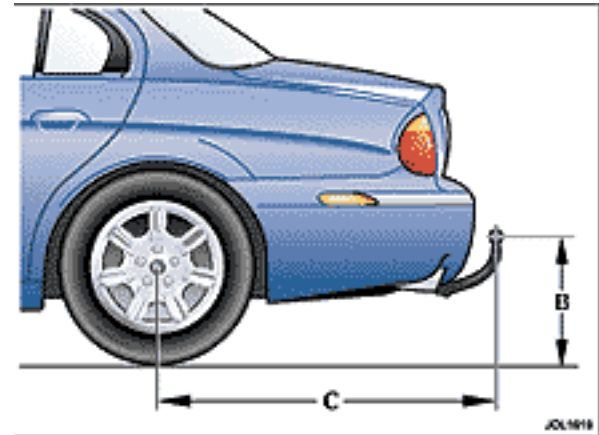

Adaptive cruise control	4-20	Battery	7-14
– changing the set speed	4-22	– charging	7-15
– entering the follow mode	4-21	– electrolyte level – check/top up	7-15
– forward alert	4-23	– lead connection/disconnection	7-16
– low speed automatic switch off	4-22	Brake/clutch fluid level check	7-10
– overriding the set speed/follow mode	4-22	Brakes	4-45
– setting a speed	4-21	Bulb renewal	
Airbags	3-3	– front direction indicator	6-14
Alarms and audible signals	2-11	– front fog lamp	6-14
– audible signals	2-11	– headlamp – dip beam	6-12
– error signal	2-11	– headlamp – main beam	6-13
– full alarm	2-11	– number plate light	6-14
Alloy wheels – care of	7-23	– parking (side) light	6-13
Alternator	7-14	– rear light assembly	6-16
Anti-freeze	7-12	– side marker	6-15
Anti-lock braking system (ABS)	4-45	– side repeater indicator	6-15
Armrest	4-37	Capacities	7-13
Audible warnings	4-7	– fuel tank	7-13
Automatic car wash	7-22	Carpets	7-21
Automatic climate control		Catalytic converters	4-55
– with LCD screen	5-4	Check and top up	
– with touch screen	5-8	– brake/clutch fluid	7-10
Automatic transmission	4-42	– engine coolant	7-12
		– engine oil	7-7
		– power steering fluid	7-9
		– washer fluid	7-11

Index

Child restraint tether anchorages	3-15	Engine	
Child safety	3-12	– anti-freeze	7-12
– door locks	2-5	– block heater	7-12
– LATCH child restraints	3-14	– coolant level check	7-12
– non-LATCH child restraints	3-13	– data	8-1
Cigar lighter and ashtray	4-38	– oil level check	7-7
Climate Control	5-1	Engine temperature	4-2
Clock adjustment	1-9	Entry/exit mode	3-18
Cloth upholstery – cleaning	7-21	Exterior care	7-22
Coolant level – check/top up	7-12	Exterior lighting	4-26
Cruise (speed) control	4-18	Fire extinguisher	4-51, 6-34
Cupholder	4-37	First aid kit	4-51
Direction indicators	4-27	Foreign travel	4-51
Door guard/puddle lamps	4-31	Fuel and refuelling	4-53
Door locks and handles	2-5	– catalytic converters	4-55
– child safety locks	2-5	– level gauge	4-1
Door mirrors		– requirements	4-54
– adjustment	3-22	– tank capacity	7-13
– power fold back	3-22	– tank filling	4-53
Door window operation	3-20	– unleaded	4-54
Drive-away door locking	2-8	Fuse box	
Dynamic stability control	4-48	– engine compartment	6-19
Earth points	7-24	– locations	6-18
Electrical accessories	7-24	– luggage compartment	6-19
Emergency starting	6-2	– passenger compartment	6-19
		Fuse replacement	6-18
		Fuses and fuse boxes	6-17

Gear-shift interlock	2-1	Instruments	4-1
General driving information	4-49	– engine temperature	4-2
General information	1-1	– fuel level gauge	4-1
General maintenance	7-1	– odometer	4-1
Glass surfaces – cleaning	7-22	– speedometer	4-1
Glove compartment	4-39	– tachometer	4-1
Grease or tar removal	7-22	Interior care	7-21
Hazard warning	4-30	Interior features	4-37
Head restraint adjustment	3-17	Interior lighting	4-31
Headlight powerwash	4-35	– reading/map lighting	4-31
Headlining – cleaning	7-21	– rear lighting	4-31
Health and safety	1-3	Interior rear view mirror	3-23
HomeLink® Universal Transceiver	2-13	Internal door locking and unlocking	2-8
– erasing transceiver buttons	2-15	Jacking	6-4
– information and assistance	2-14	Jaguar	
– programming	2-13	– Dealers	1-1
– reprogramming a transceiver button	2-15	– diagnostic system	1-4
– training procedure	2-15	– parts and accessories	1-1
Hood release	7-3	JaguarNet Telematics system	1-10
Horn	4-32	– message list	1-14
Ignition switch	2-1	Key transmitter	2-3
Illuminated entry/exit	4-31	– battery renewal	2-4
Inertia switch	6-1	– care of	2-3
Infant safety	3-13	Keys	2-2

Index

- Lamp check 4-3
- Leather upholstery – cleaning 7-21
- Lights
 - autolamps 4-26
 - daylight running lights 4-27
 - exit delay 4-27
 - exterior lights 4-26
 - front fog lights 4-28
 - rear fog lights 4-28
- Limp home mode 4-43
- Locking and unlocking
 - child safety locks 2-5
 - drive-away door locking 2-8
 - luggage compartment 2-9
 - vehicle 2-5
- Locking wheel nuts 6-5
- Luggage
 - tie-down loops 3-27
- Luggage compartment 3-26
- Luggage compartment emergency release 2-10

- Maintenance
 - general precautions 7-1
 - regular checks 7-4
 - reservoir and dipstick locations 7-5, 7-6
- Manual transmission 4-44
- Memory setting – driving positions 3-24

- Message centre 4-8
 - clearing messages 4-18
 - illumination 4-8
 - messages 4-9
- Mirror
 - heating 3-22
 - interior 3-23
 - power fold back 3-22
- Mobile/portable phones 1-6

- Occupant protection 3-1
- Oil specification 7-8

- Paint chips 7-23
- Paint – polishing 7-23
- Panic alarm 2-12
- Parkbrake 4-36
- Power steering fluid level check 7-9
- Powerwash system fluid level check 7-11
- Protect the environment 1-6

- Radio frequency approval 2-12
- Rain sensitive wiper control 4-34
- Rear centre armrest 4-37
- Rear seat back fold down 3-26
- Rear sun blind 4-29
- Recommended engine oil 7-8

Regular checks and top ups	7-4	Tachometer	4-1
– brake/clutch fluid	7-10	Temporary-use spare wheel	6-5
– engine coolant	7-12	Touch-screen display	1-7
– engine oil	7-7	Touring	4-51
– power steering fluid	7-9	Tow-bar fixing points	8-6
– windscreen washer fluid	7-11	Towing a caravan or trailer	4-52
Regular servicing	1-4	Towing eye	6-10
Reservoir and dipstick locations	7-5, 7-6	Traction control	4-47
Reverse park control	4-32	Trailer weights	8-3
Roadside emergency	6-1	Trip computer	4-16
Roof-rack	4-51	Tyre pressures	8-5
– capacity	8-3	Tyres	7-18
		– damage	7-19
Seat adjustment	3-16	– pressures	7-18
Seat belt		– renewal	7-18
– fitting	3-1	– repair	7-19
– inertia reel mechanism check	3-2	– snow chains	7-20
Security		– wear	7-19
– to lock the vehicle and set the alarm	2-6	– winter	7-20
– to unlock and disarm the vehicle	2-6		
Snow chains	7-20	Underhood cleaning	7-23
Specifications	8-1	Used engine oil	7-2
Speedometer	4-1		
Sport mode	4-44		
Starting/stopping the vehicle	4-40		
Steam cleaning – underhood area	7-23		
Steering column adjustment	3-18		
Sun visors	4-38		
Sunroof	4-33		

Index

Valet switch	2-8	Window	
Vanity mirrors	4-38	– anti-trap feature	3-21
Vehicle		– operation	3-20
– care	7-21	– tinting	1-6
– data	8-1	Windscreen	
– engine number	1-5	– cleaning	7-22
– global locking	2-7	– washer/powerwash fluid – check/top up	7-11
– identification	1-5	– wipers/washers	4-34
– immobilisation system	2-2	– wipers/washers – maintenance	7-17
– locking/unlocking	2-5	Winter driving	4-50
– recovery	6-8	Winter tyres	7-20
– security	2-2	Wipers and washers – operation	4-34
– smart locking	2-5		
– transporting	6-8		
Vehicle identification	1-5		
Vehicle identification number (VIN)	1-5		
Warning and cautions	1-2		
Warning lights – instruments	4-2		
Warning symbols on the vehicle	1-2		
Warning triangle	4-51		
Washing – vehicle	7-22		
Weights	8-2		
Wheel changing and jacking	6-4		
Wheel/tyre data	8-4		