

Published: 11-May-2011

Interior Trim and Ornamentation - Headliner





Removal and Installation

Removal



NOTE: Removal steps in this procedure may contain installation details.

All vehicles

1. Refer to: [Battery Disconnect and Connect](#) (414-01 Battery, Mounting and Cables, General Procedures).
2. Refer to: [Interior Rear View Mirror](#) (501-09 Rear View Mirrors, Removal and Installation).
3. Refer to: [Overhead Console](#) (501-12 Instrument Panel and Console, Removal and Installation).
4.  NOTE: The procedure must be carried out on both sides.
Refer to: [Sun Visor](#) (501-05 Interior Trim and Ornamentation, Removal and Installation).
5.  NOTE: The procedure must be carried out on both sides.
Refer to: [A-Pillar Trim Panel](#) (501-05 Interior Trim and Ornamentation, Removal and Installation).
6.  NOTE: The procedure must be carried out on both sides.
Refer to: [B-Pillar Upper Trim Panel](#) (501-05 Interior Trim and Ornamentation, Removal and Installation).
7.  NOTE: The procedure must be carried out on both sides.
Refer to: [C-Pillar Lower Trim Panel](#) (501-05 Interior Trim and Ornamentation, Removal and Installation).
8. Refer to: [Windshield Glass](#) (501-11 Glass, Frames and Mechanisms, Removal and Installation).

9.

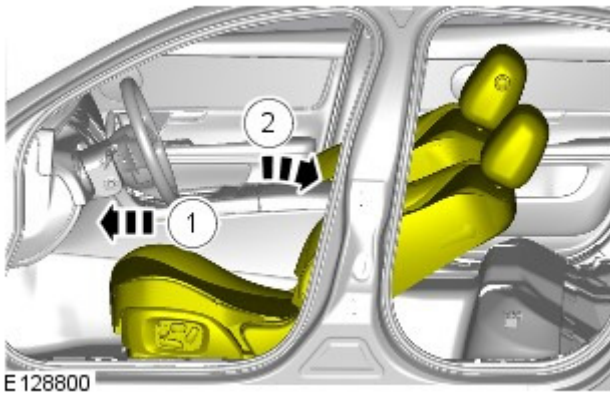

10. Torque: 2 Nm

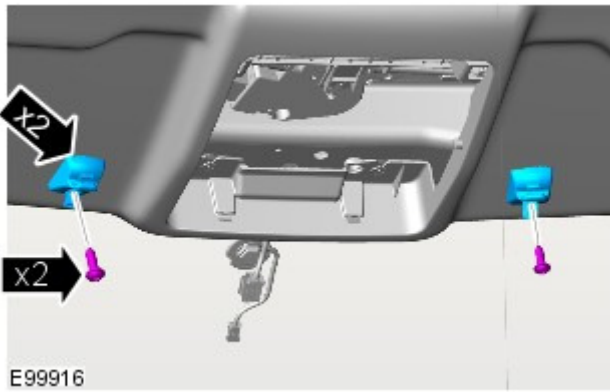

11.

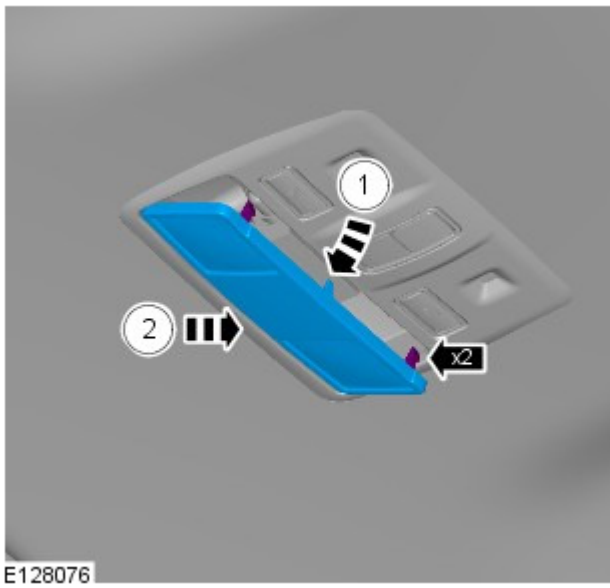

12.

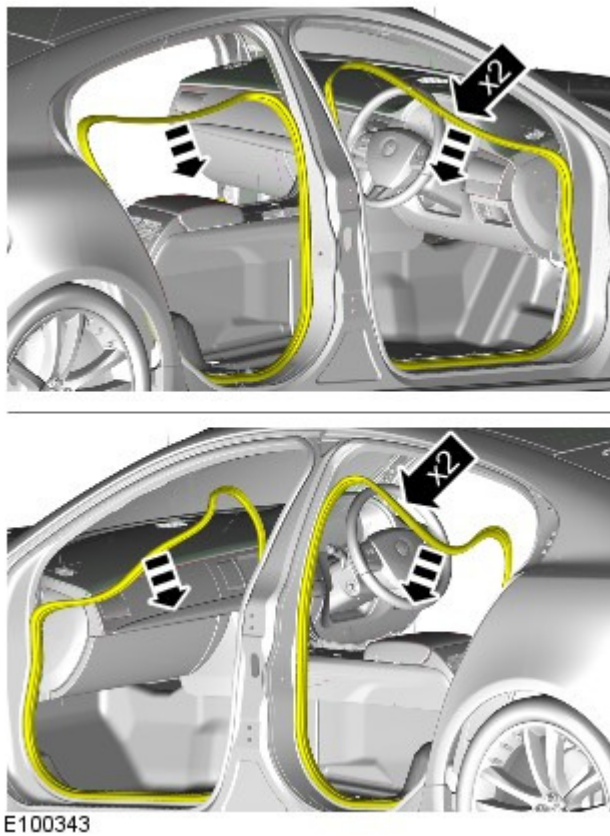
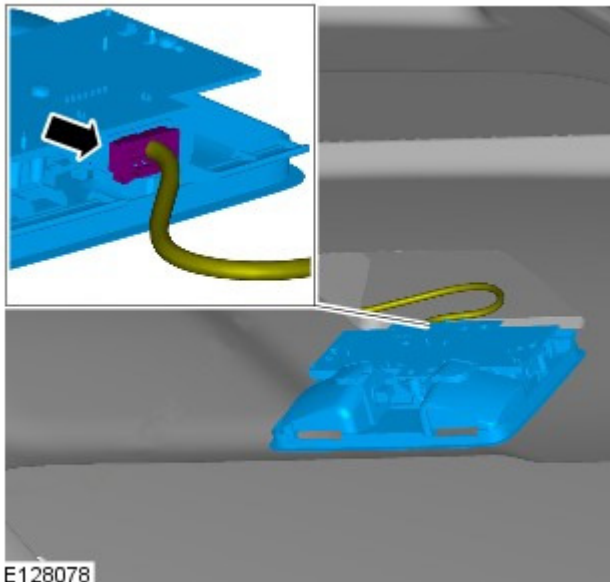

13.  NOTE: Some variation in the illustrations may occur, but the essential information is always correct.

14. NOTES:

 Make sure that the component is installed to the position noted on removal.

 Right-hand shown, left-hand similar.

 The procedure must be carried out on both sides.

Torque: 2 Nm

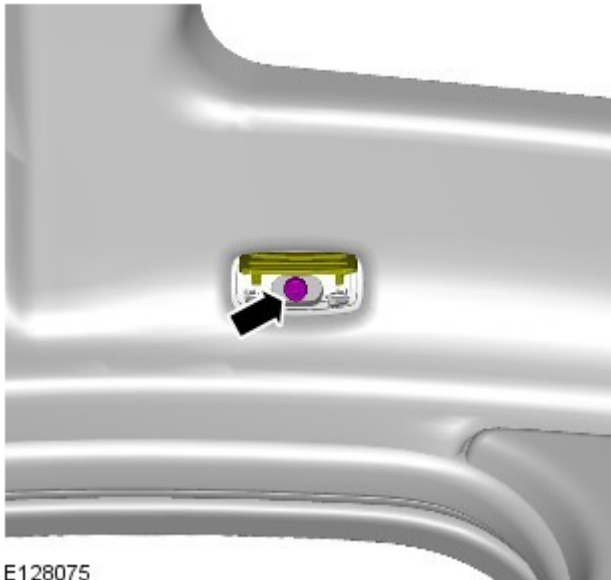

E128075

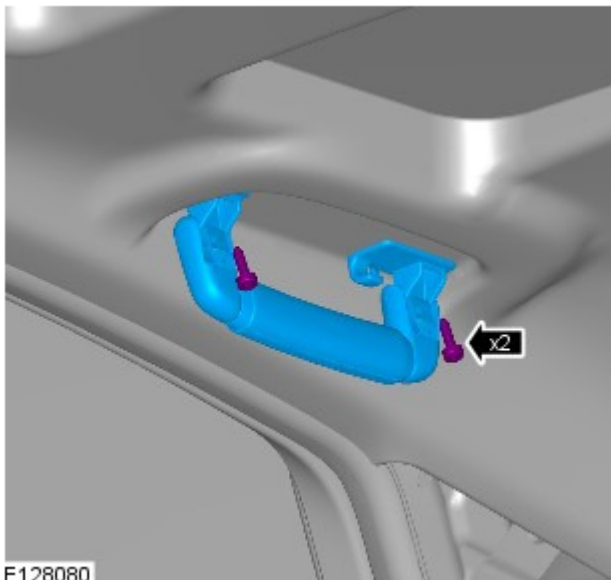

E128080

15. NOTES:

 Make sure that the component is installed to the position noted on removal.

 Right-hand shown, left-hand similar.

 The procedure must be carried out on both sides.

Torque: 2 Nm

16.

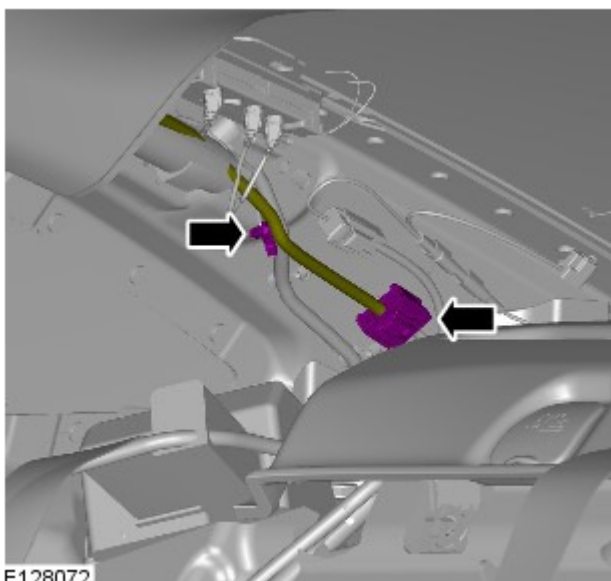

E128072

- 17.  **WARNING:** This step requires the aid of another technician.

CAUTIONS:

-  Note the fitted position of the component prior to removal.

-  Make sure that these components are installed to the noted removal position.

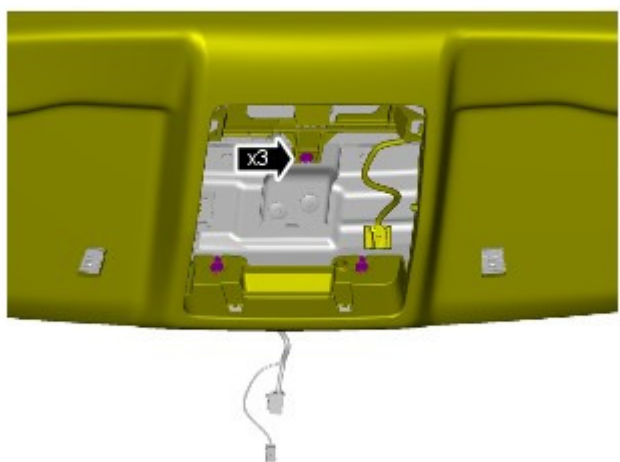

E128070

- 18.  **NOTE:** This step requires the aid of another technician.

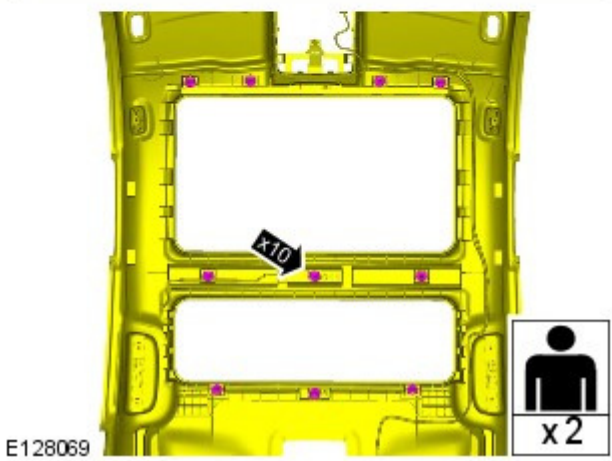

E128069

- 19.  **NOTE:** This step requires the aid of another technician.

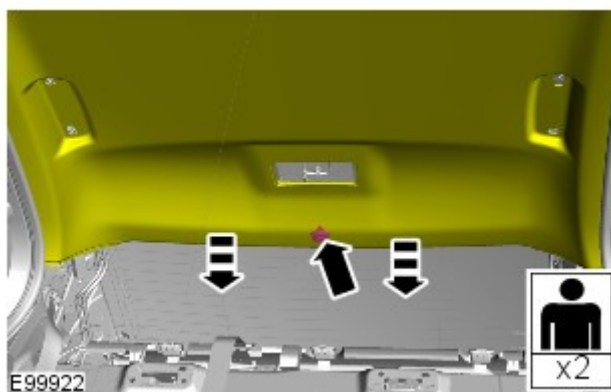
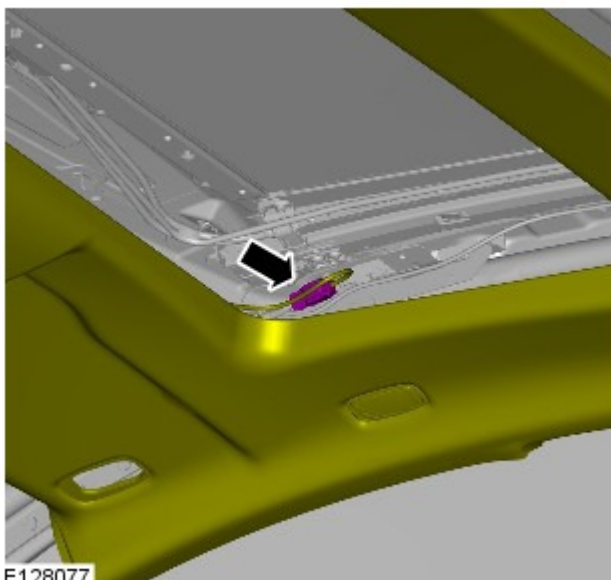

20.  **WARNING:** This step requires the aid of another technician.

21. **NOTES:**

 This step requires the aid of another technician.

 Make sure the front and rear passenger assist handles and headliner retaining clips are installed to the headliner prior to installation.

22.  **CAUTION:** Note the fitted position of the component prior to removal.

NOTES:

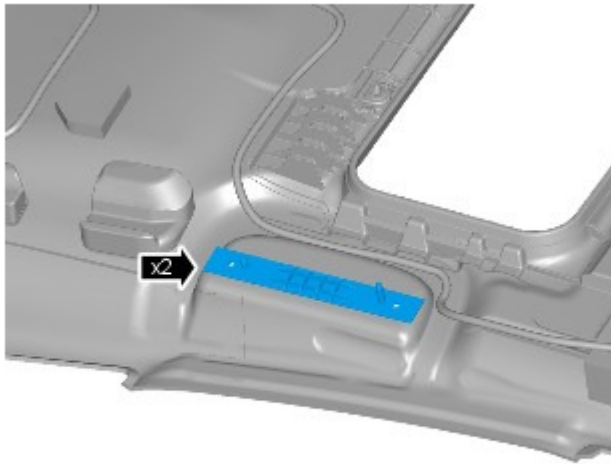

 Make sure that the component is installed to the position noted on removal.

 Right-hand shown, left-hand similar.

 The procedure must be carried out on both sides.

E128068

Long wheelbase

23. NOTES:

 Do not disassemble further if the component is removed for access only.

 Left-hand shown, right-hand similar.

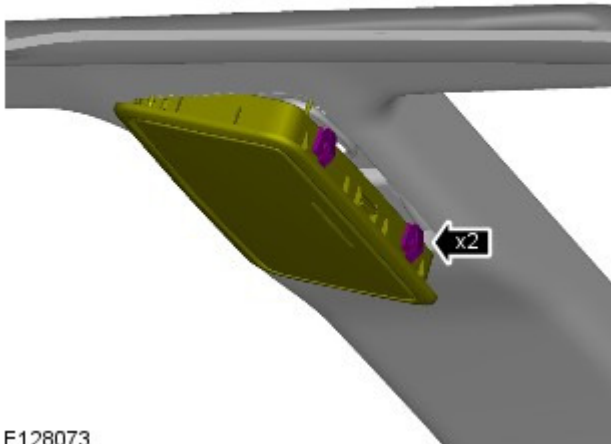

E128073

24.  NOTE: Left-hand shown, right-hand similar.

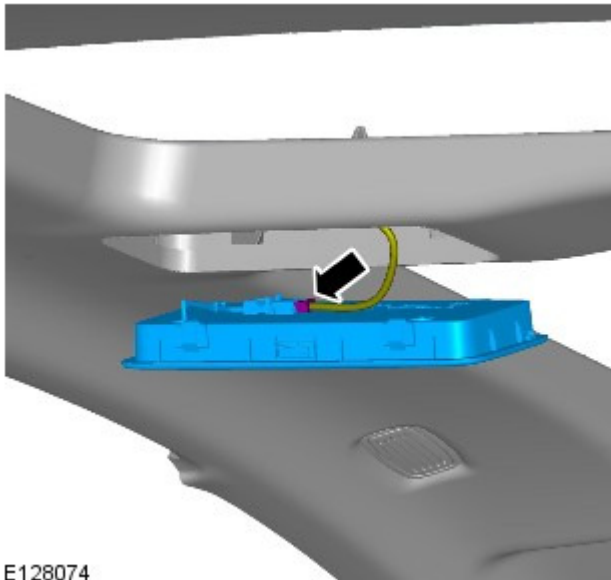

E128074

Installation

1. To install, reverse the removal procedure.