

Interior Trim and Ornamentation - Parcel Shelf

Removal and Installation

Removal

All vehicles

1. Refer to: [C-Pillar Lower Trim Panel](#) (501-05 Interior Trim and Ornamentation, Removal and Installation).

Vehicles with electric rear blind

2.

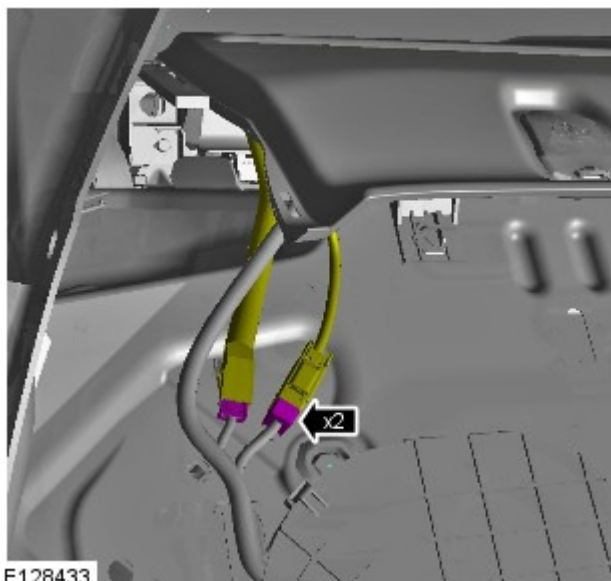

Vehicles without electric rear blind

3.

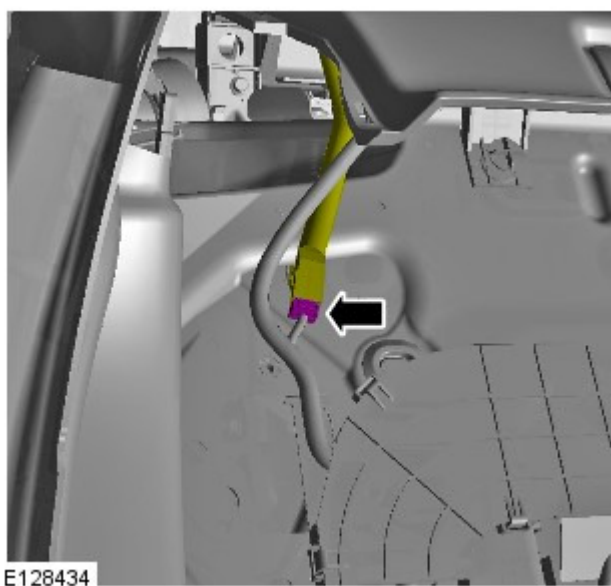

All vehicles

4.

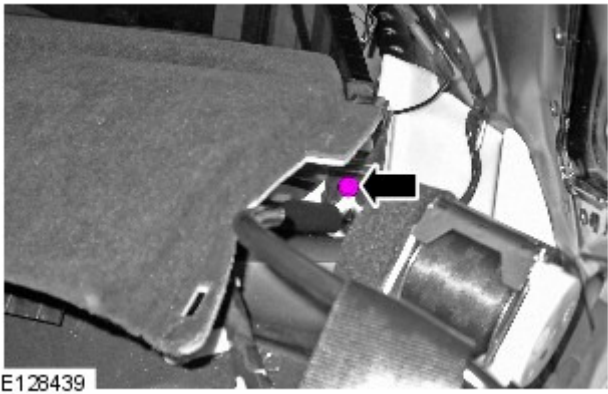
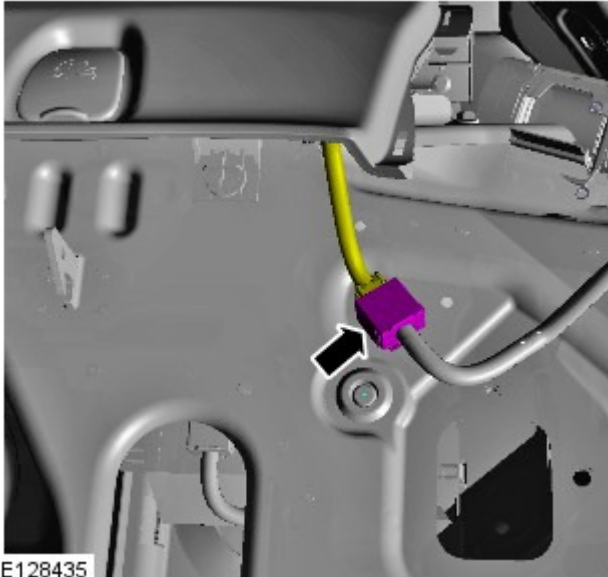

5.  NOTE: Loosen the bolt, but do not fully remove.

6.  NOTE: Loosen the bolt, but do not fully remove.

7.

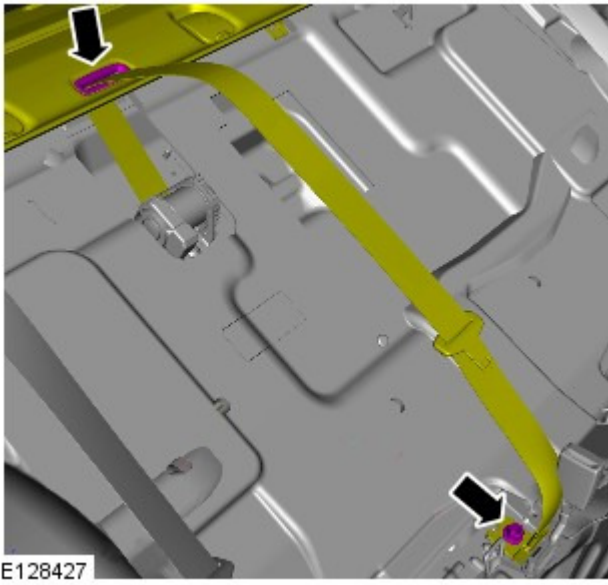
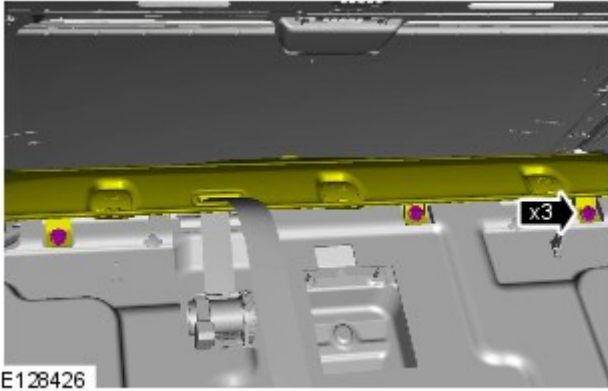

8.

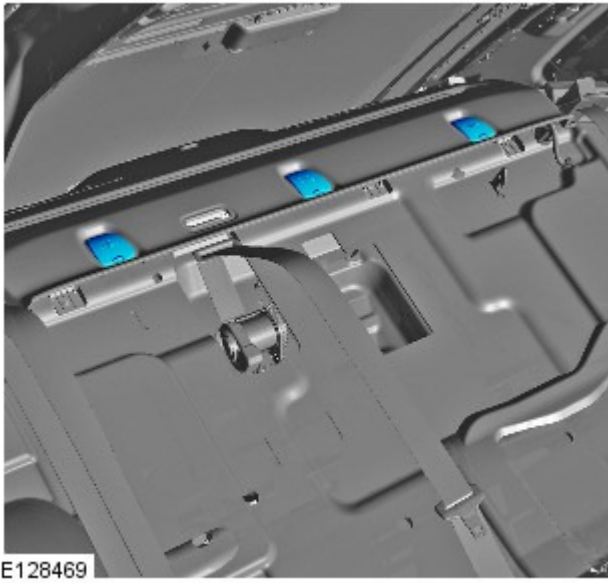

9.

10.

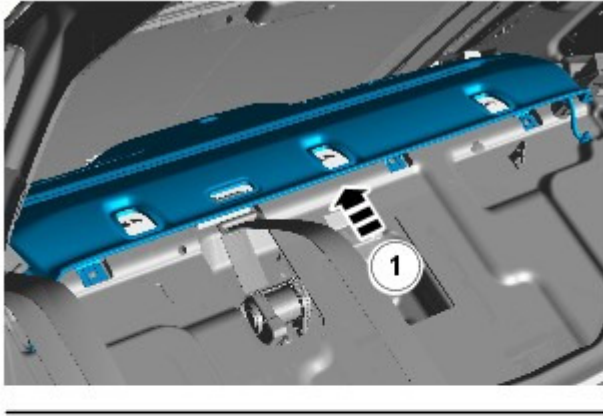

E128428

Installation

All vehicles

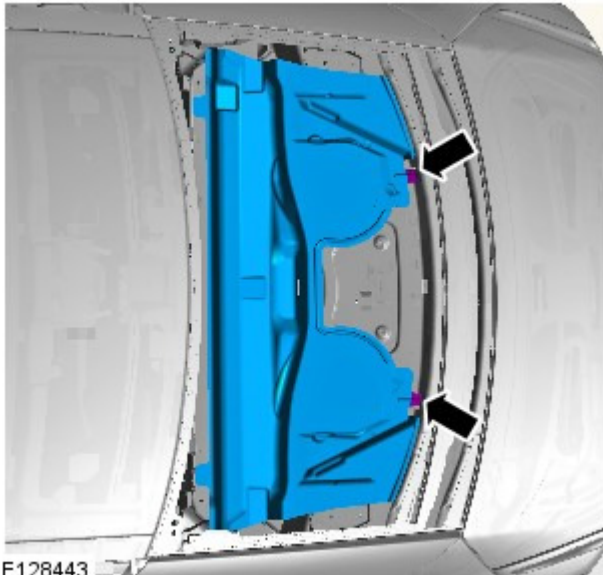

E128443

1.  CAUTION: Make sure that the noise vibration harshness (NVH) material is correctly located.

2.  CAUTION: Make sure that the wiring harness does not catch when installing the parcel shelf.

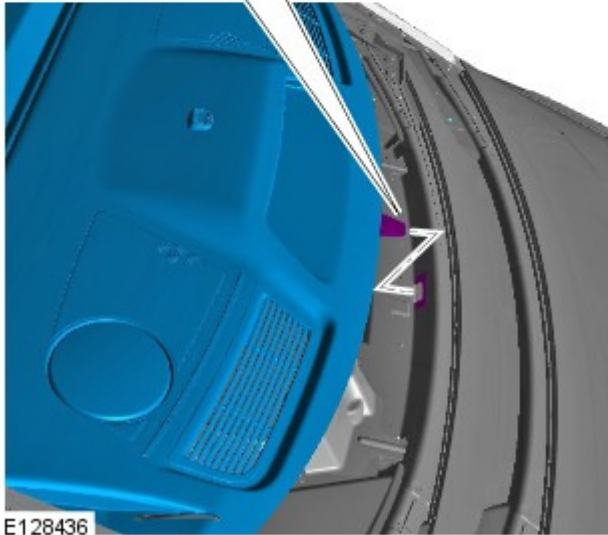
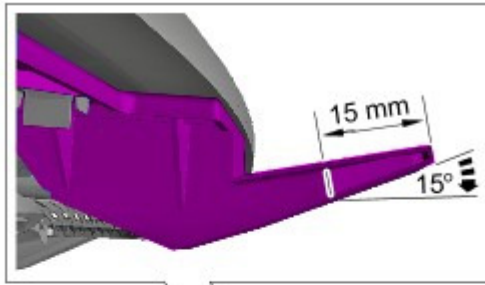

E128436

3. Torque: 40 Nm

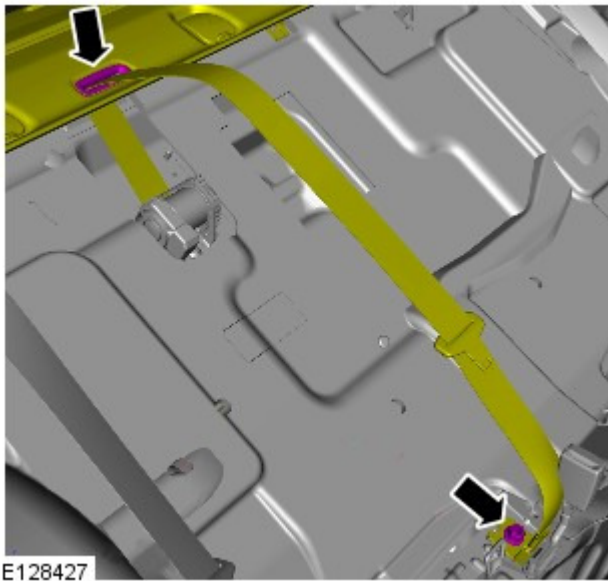

E128427

4.



E128469

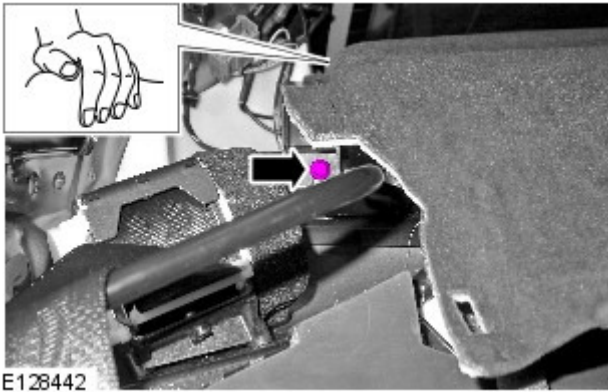

E128442

5.
 - Torque: 6 Nm
 - Apply gentle pressure.

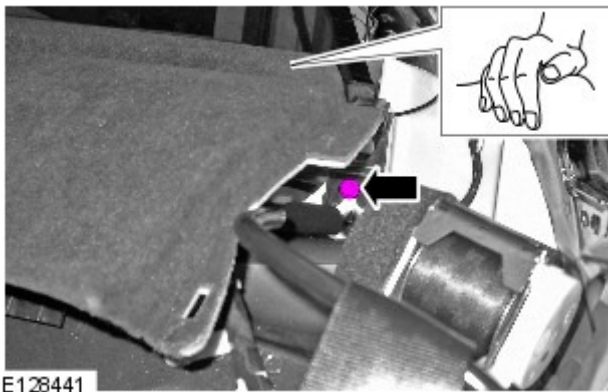

E128441

6.
 - Torque: 6 Nm
 - Apply gentle pressure.

7.

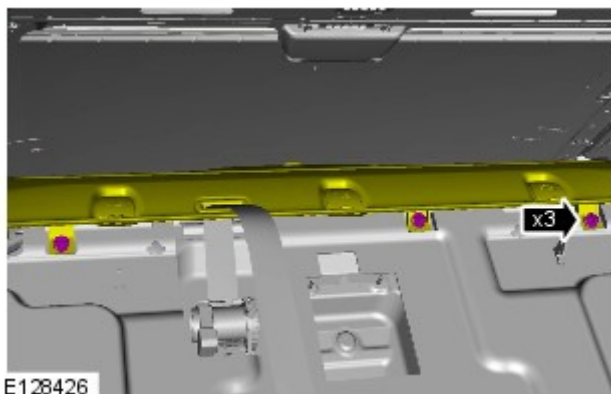

Vehicles with electric rear blind

8.

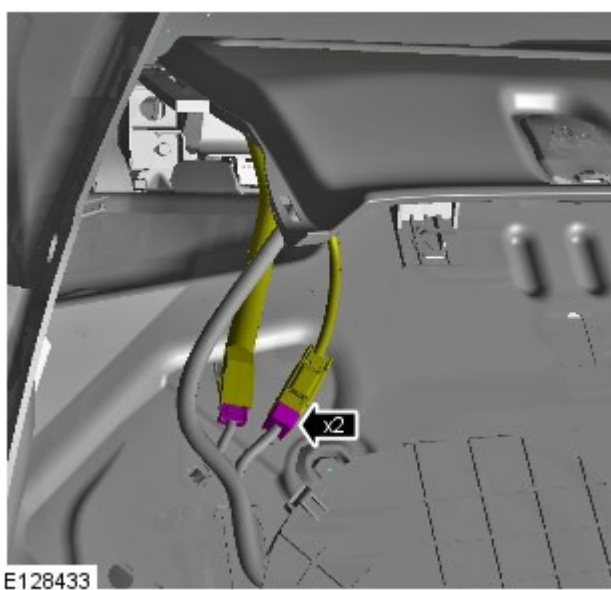

Vehicles without electric rear blind

9.

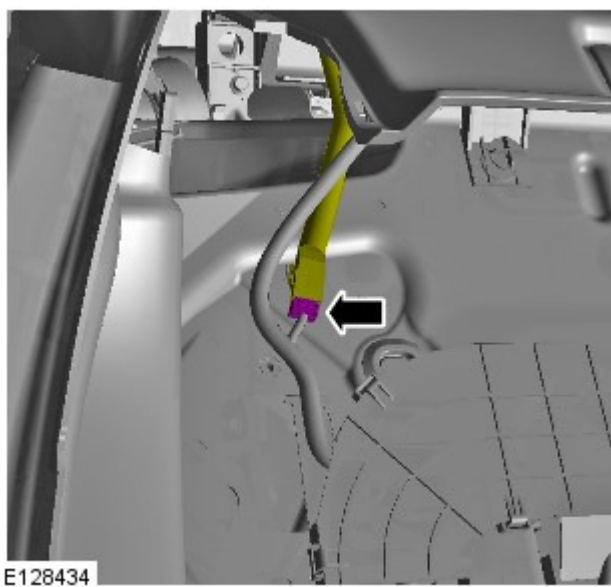

All vehicles

10.

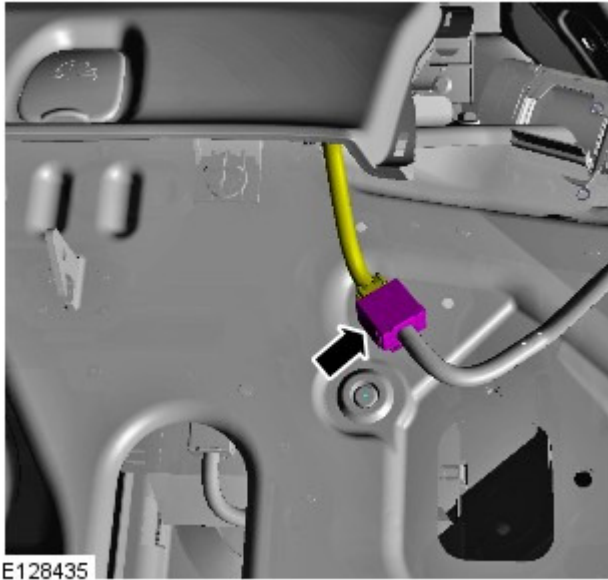

11. Refer to: [C-Pillar Lower Trim Panel](#) (501-05 Interior Trim and Ornamentation, Removal and Installation).