

JAGUAR XJ 2019



THE ART OF PERFORMANCE





BY APPOINTMENT TO
HM THE QUEEN
MANUFACTURERS OF
MOTOR VEHICLES
JAGUAR LAND ROVER LIMITED
COVENTRY



BY APPOINTMENT TO
HRH THE DUKE OF EDINBURGH
MANUFACTURERS OF
MOTOR VEHICLES
JAGUAR LAND ROVER LIMITED
COVENTRY



BY APPOINTMENT TO
HRH THE PRINCE OF WALES
MANUFACTURERS OF
MOTOR VEHICLES
JAGUAR LAND ROVER LIMITED
COVENTRY



JAGUAR

THE ART OF PERFORMANCE

Every day we push performance to its limit. Our performance. Our cars' performance.
We innovate, we engineer, we design. We master rules and then break them.
Only to push further. Past the limits of convention. This is when performance becomes art.

Jaguar. The Art of Performance.



CONTENTS

INTRODUCTION

The Concept of XJ	06
The XJ – The Facts	08

DESIGN

Exterior Principles	10
Exterior – A Powerful Look	13
Exterior View	15
Interior Technology	17
Interior Luxury	18
Interior Comfort	21
Interior Space	23

PERFORMANCE

Engines	24
All-Aluminum Body	26
Advanced Driving Dynamics	28
XJR575 – The Most Powerful and Agile XJ	33
XJR575 – Sporting Style	35

DRIVING TECHNOLOGY

Added Driver Assistance	36
Advanced Drivetrain Technology	38

TECHNOLOGY

Infotainment	41
Connectivity	42
Audio	46

ASSISTANCE AND EFFICIENCY

Driver Assistance	48
Efficient Technologies	50

XJ50 SPECIAL EDITION

53

PERSONALIZATION

The XJ – Your Choice	56
Choose your Engine	58
Choose your Model	60
Choose your Options	62
Choose your Colour	68
Choose your Wheels	70
Choose your Interior	72
Choose your Jaguar Gear – Accessories	84

TECHNICAL SPECIFICATIONS

86

SPECIAL VEHICLE OPERATIONS

90

THE WORLD OF JAGUAR

92

AT YOUR SERVICE

95

VEHICLE SHOWN: 2019 JAGUAR XJ R-SPORT STANDARD WHEELBASE IN SANTORINI BLACK WITH OPTIONAL EQUIPMENT
VEHICLES SHOWN ARE FROM THE JAGUAR GLOBAL RANGE. SPECIFICATIONS, OPTIONS AND AVAILABILITY WILL VARY BETWEEN MARKETS
AND SHOULD BE VERIFIED WITH YOUR LOCAL JAGUAR RETAILER

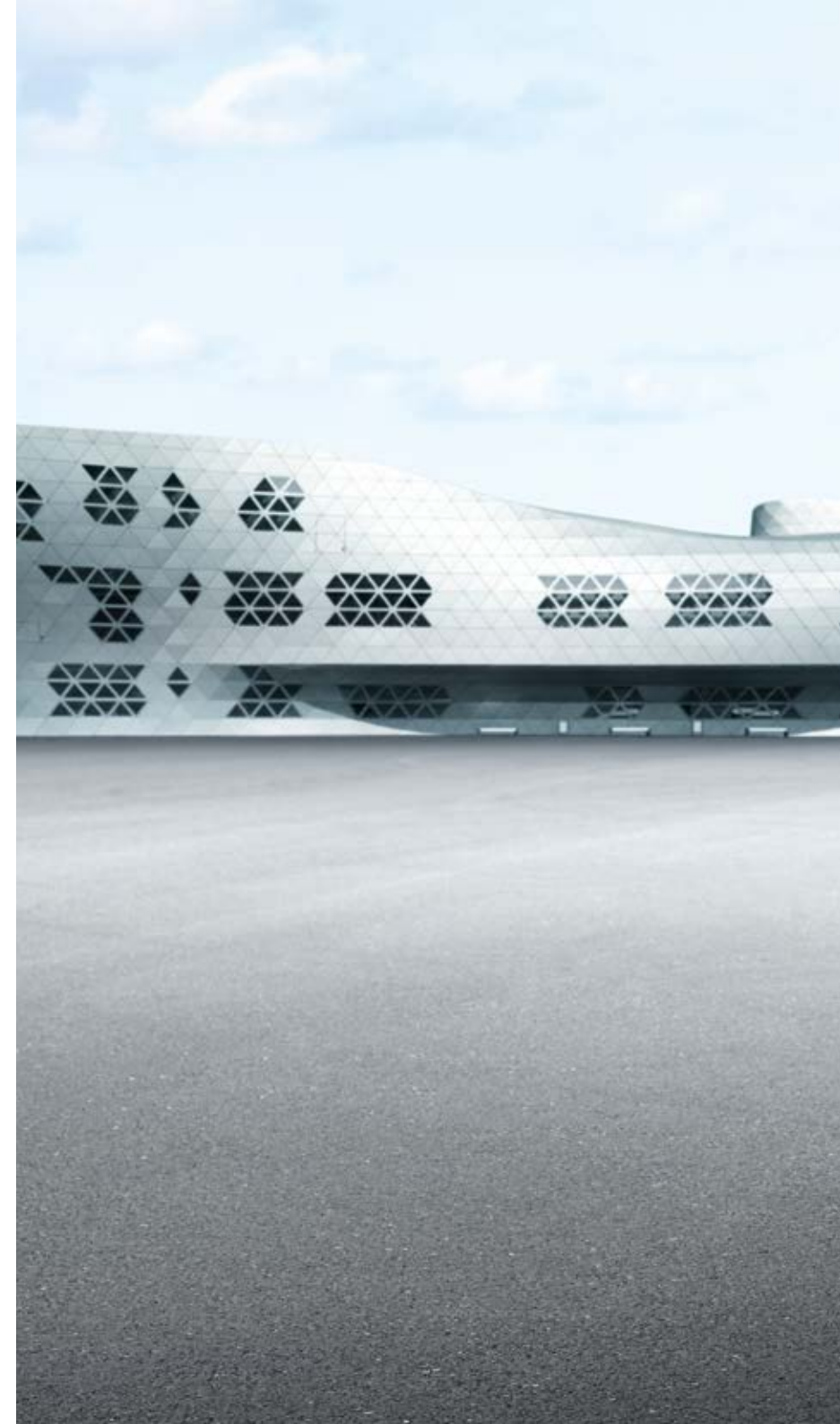

INTRODUCTION

THE CONCEPT OF XJ

The pinnacle sedan of the Jaguar line-up, the XJ is the perfect combination of cutting edge technology, sporting vehicle dynamics, and opulent luxury. In the cabin, there's space to stretch out, relax or work using our latest Jaguar Incontrol® connected technology, Touch Pro*. With the new 10" Touchscreen and the availability of 4G Wi-Fi Internet**, the XJ has everything you need to make your journey more productive, entertaining and relaxed.

Always working with you is an enhanced suite of Advanced Driver Assist Systems¹ including Emergency Braking, Lane Keep Assist and Adaptive Cruise Control with Queue Assist[†]. While energy efficient full-LED headlights, standard on every XJ, produce piercing beams of light with a quality close to daylight for better visibility at night.

For half a century, the XJ has pushed the boundaries to deliver innovation and style. Today we mark this milestone with the special edition XJ50. With its advanced driving technologies and, of course, supreme comfort, the XJ50 truly is one of a kind.

*Do not use Jaguar InControl® features under conditions that will affect your safety or the safety of others. Driving while distracted can result in loss of vehicle control. **The Wi-Fi hotspot is intended for passenger use only. InControl features may require an additional subscription with separate terms and conditions. †These features are not a substitute for driving safely with due care and attention and will not function under all circumstances, speeds, weather and road conditions, etc. Driver should not assume that these features will correct errors of judgment in driving. Please consult the owner's manual or your local Jaguar Retailer for more details.

¹See page 48 for details.

VEHICLE SHOWN: 2019 JAGUAR XJL PORTFOLIO LONG WHEELBASE IN LOIRE BLUE WITH OPTIONAL EQUIPMENT



THE XJ - THE FACTS

The technology developed by Jaguar is focused on enhancing the journey for you and your passengers. Dynamic systems assist performance, handling and comfort. The XJ also features the latest connected technology and an array of luxury interior choices.

CONNECTED CAR

Jaguar InControl® is a package of applications and technologies that keeps the XJ connected to the world. It runs a suite of useful smartphone apps from the 10" Touchscreen*. The InControl services, technologies and applications give you the very best in connectivity and convenience, all supported by a fast 4G Wi-Fi Internet connection through a powerful external antenna**. With Remote you can connect to, and monitor, your Jaguar XJ from anywhere and even pre-heat or cool the cabin before entering.

BREADTH OF PERFORMANCE

Powerful and refined, for a thrilling and rewarding drive. The XJ offers two highly advanced engines – 3.0 litre V6 and 5.0 litre V8. The 5.0 litre V8 engine is available in one power output – 575HP, achieving 0-100km/h in as little as 4.4 seconds†. Featuring an 8-speed automatic transmission with Intelligent Stop/Start technology.

ALL-ALUMINUM CONSTRUCTION

The XJ all-aluminum body architecture is designed to be strong and rigid but also extremely light making the car highly responsive and agile, as well as fuel efficient. Riveted, and without a single welded joint, the 100 percent aluminum monocoque body structure makes the car lighter and without compromise to the integrity of its body.

*Do not use Jaguar InControl® features under conditions that will affect your safety or the safety of others. Driving while distracted can result in loss of vehicle control. **The Wi-Fi hotspot is intended for passenger use only. InControl features may require an additional subscription with separate terms and conditions. †Always follow local speed limits.

†Standard on Portfolio, XJ50 and XJR575. Not available on other models.

VEHICLE SHOWN: 2019 JAGUAR XJ50 LONG WHEELBASE IN LOIRE BLUE WITH OPTIONAL EQUIPMENT

INCONTROL TOUCH PRO™

Putting all the essential in-car controls and a world of entertainment at your fingertips is the next-generation XJ Touch Pro infotainment system, part of Jaguar InControl® technologies. It features a larger 10" tablet-style Touchscreen* with intuitive swipe and pinch-to-zoom navigation.

COLOURS AND MATERIALS

The XJ provides true luxury choice throughout. A wealth of materials and finishes are at your disposal, including beautiful soft grain leather seats defined in a Diamond Quilted contrast stitched pattern¹. Exclusive colour coordination continues throughout the cabin.



'DOUBLE J' HEADLIGHTS

Jaguar's unique 'Double J' Daytime Running Lights give the XJ a distinctive appearance. The full LED headlights supply a 'whiter' light than conventional Xenon beams. Being closer to daylight, objects can be better recognized, helping increase comfort and visibility during night driving.

WHEELS

The XJ has an extensive selection of wheels and finishes including the XJ50 exclusive 5 split-spoke 'Style 5045' alloy wheels with a Gloss Black and Diamond Turned finish.



DESIGN EXTERIOR PRINCIPLES



DESIGN PURITY

POWERFUL STANCE

The XJ stands out: authoritative, elegant, and powerful. The teardrop shape is formed for optimum aerodynamic efficiency, reducing air resistance to a minimum, improving acceleration. The shape is the result of exhaustive computational modeling where aesthetics and aerodynamics work together. The chrome outlined side windows emphasize the pure, elongated form of the XJ. The low, wide stance and long, taut waistline create a commanding presence, while inside the cabin still feels airy and spacious thanks to its panoramic roof and smart design.

VEHICLE SHOWN: 2019 JAGUAR XJL PORTFOLIO IN LOIRE BLUE WITH OPTIONAL EQUIPMENT







EXTERIOR - A POWERFUL LOOK

 **BOLD FRONT GRILLE** | **'DOUBLE J' HEADLIGHTS**

The assertive front styling includes an upright front grille design with mesh detail. The grille is framed by energy efficient full-LED headlights, sporting unique Jaguar 'Double J' Daytime Running Light design. Producing a light with a colour temperature closer to natural daylight, objects can be better recognized helping increase comfort and visibility during night driving. At the rear, finishing touches include elliptical tailpipes and LED tail lights incorporating a distinctive pinstripe graphic that provides a crisp and clear 'ribbon of light'. The LED tail lights are brighter, more efficient and illuminate faster than halogen bulbs contributing to the overall drive for greater efficiency.

VEHICLE SHOWN: 2019 JAGUAR XJ R-SPORT STANDARD WHEELBASE IN SANTORINI BLACK WITH OPTIONAL EQUIPMENT





EXTERIOR VIEW

FULL WIDTH PANORAMIC ROOF

The view from inside XJ is extensive: a panoramic, full width, heat-reflective glass roof sweeps back and over the rear seats. It filters UV rays and floods the interior with natural light making it feel airy, spacious and, thanks to effective tinting, very private. Power operated blinds allow you to completely block the light when required. Specially formulated toughened glass helps to keep the cabin cool.

VEHICLE SHOWN: 2019 JAGUAR XJL PORTFOLIO IN CARPATHIAN GREY WITH OPTIONAL EQUIPMENT



JAGUAR

HOME 14:55

Navigation	Media	Phone
Arlington Avenue Leamington Spa W 45 km 16:05	Bluetooth audio Young Before Your Time Covizor	My iPhone

Navigation, Media, Phone, Bluetooth audio, Young Before Your Time, Covizor, My iPhone

Navigation, Media, Phone, Bluetooth audio, Young Before Your Time, Covizor, My iPhone



INTERIOR TECHNOLOGY

CONNECTED INFOTAINMENT

The high-definition Interactive Driver Display puts everything you need to know about your driving right in front of you. The 12.3" screen displays the speed, fuel and temperature gauges and can be set to display the most relevant information, depending on the situation and set up. This multi-layered virtual display combines a user-friendly graphical interface with advanced functionality to make finding the right settings even easier.

The Interactive Driver Display is fully integrated with the 10" Touchscreen to put all information behind the wheel or on the centre console. For example, when working with Navigation Pro the Interactive Driver Display can be reconfigured to show 3D mapping, making following your route even simpler*.

*Do not use Jaguar InControl® features under conditions that will affect your safety or the safety of others. Driving while distracted can result in loss of vehicle control.

INTERIOR SHOWN: 2019 JAGUAR XJ PORTFOLIO LONG WHEELBASE SHOWING IVORY SOFT GRAIN PERFORATED LEATHER SEATS WITH EBONY CONTRAST STITCH, EBONY UPPER FACIA, EBONY SUEDECLOTH HEADLINING AND GLOSS RICH OAK VENEER WITH OPTIONAL EQUIPMENT

INTERIOR LUXURY

 CRAFTSMANSHIP | EXTENSIVE CHOICE

The quality of craftsmanship throughout the XJ cabin sets it apart. With a wide choice of colours, materials and finishes, the interior reflects the clarity and purity of the XJ exterior. The hand-crafted veneer that runs right around the cabin accentuates the sense of space. The sporting character of Jaguar is present in the controls and architecture surrounding the driver including the leather-wrapped, three-spoke steering wheel that offers key controls at your fingertips.

INTERIOR SHOWN: 2019 JAGUAR XJL PORTFOLIO WITH OPTIONAL PREMIUM REAR SEAT PACKAGE SHOWING IVORY SOFT GRAIN PERFORATED LEATHER SEATS WITH EBONY CONTRAST STITCH, EBONY UPPER FACIA, EBONY SUEDECLOTH HEADLINING AND GLOSS BURR WALNUT VENEER WITH OPTIONAL EQUIPMENT







INTERIOR COMFORT



FRONT PASSENGER SEAT AWAY

HEATING AND COOLING FUNCTIONS

MESSAGE SEATS

The multi-functional seating in the XJ gives you complete control of your comfort. Both front seats feature fine-tuned electric adjustment and can be specified with five different massage programs. Both front and rear seats are heated. All seats feature a cooling function as well. Some XJ models also offer three-position user memory on the driver and front passenger seats. Long Wheelbase models can be further enhanced with a choice of Rear Seat Option Packages, featuring two individual airline-style reclining seats complete with three massage programs and memory. The reclining rear seats can be programmed to return to an upright position when the door is opened and a 'front passenger seat away' function allows rear occupants to move the empty front passenger seat forward to increase legroom and aid access.

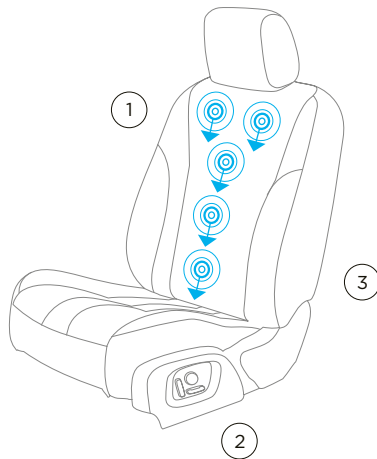

FRONT SEATS

Available with five different massage programs, electric adjustment with three-position memory and heated/cooling function.

1. Five massage programs
2. Three position memory function
3. Cooling function

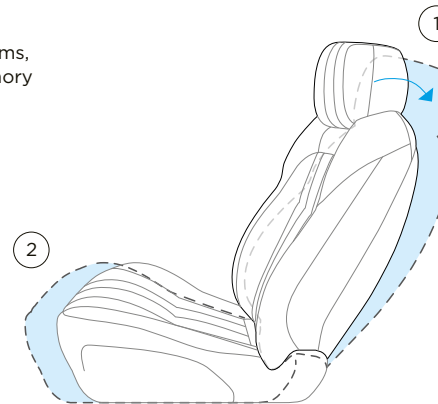

REAR SEATS

Available on Long Wheelbase models with airline-style recline, three different massage programs, electric adjustment with two-position memory.

1. Total recline movement is 11 degrees
2. 103 mm of longitudinal cushion movement and separate 14.5 degrees of upper articulation movement

INTERIOR SHOWN: 2019 JAGUAR XJL PORTFOLIO WITH OPTIONAL PREMIUM REAR SEAT PACKAGE SHOWING IVORY SOFT GRAIN PERFORATED LEATHER SEATS WITH EBONY CONTRAST STITCH, EBONY UPPER FACIA, EBONY SUEDECLOTH HEADLINING AND GLOSS BURR WALNUT VENEER WITH OPTIONAL EQUIPMENT





1. LWB headroom 946mm 2. LWB knee room 189mm

INTERIOR SPACE

> OVER A METRE OF LEGROOM | **LIMOUSINE RIDE**

Long Wheelbase models feature over a metre of legroom for rear seat passengers providing the perfect environment to work, enjoy a host of entertainment options, or simply stretch out and relax. Long Wheelbase models also feature a unique 'limousine' ride with revised air suspension settings for even more refined comfort.

Depending on the model, or options chosen, the rear cabin can be further enhanced with individual 10" HD screens. The centre armrest houses the multimedia remote and front and rear seat controls, as well as providing useful storage. Folding business tables, LED reading lights, drop-in footrests and electric side rear window blinds are also available to add comfort, convenience and privacy.

INTERIOR SHOWN: 2019 JAGUAR XJL PORTFOLIO WITH OPTIONAL PREMIUM REAR SEAT PACKAGE SHOWING IVORY SOFT GRAIN PERFORATED LEATHER SEATS WITH EBONY CONTRAST STITCH, EBONY UPPER FACIA, EBONY SUEDECLOTH HEADLINING AND GLOSS BURR WALNUT VENEER WITH OPTIONAL EQUIPMENT

PERFORMANCE ENGINES



STOP/START TECHNOLOGY

The XJ offers two highly advanced engines - 3.0 litre V6 and 5.0 litre V8. Each features a Roots-type twin vortex supercharger that maintains the engines' compact dimensions.



V6 ENGINE

0-100km/h from 6.4 sec*

Powerful and refined, for a thrilling and rewarding drive. The compact supercharger's sophisticated boost control and secondary throttle valve give you a burst of power when you accelerate, with minimal lag. The water-cooled intercooler reduces air intake temperature for more power. The XJ 3.0 litre 340HP Supercharged engine offers economy and performance, achieving 0-100km/h in 6.4 seconds* due to its 332 lb-ft of torque. The engine uses an 8-speed automatic transmission and also includes Stop/Start technology.

*Always follow local speed limits.

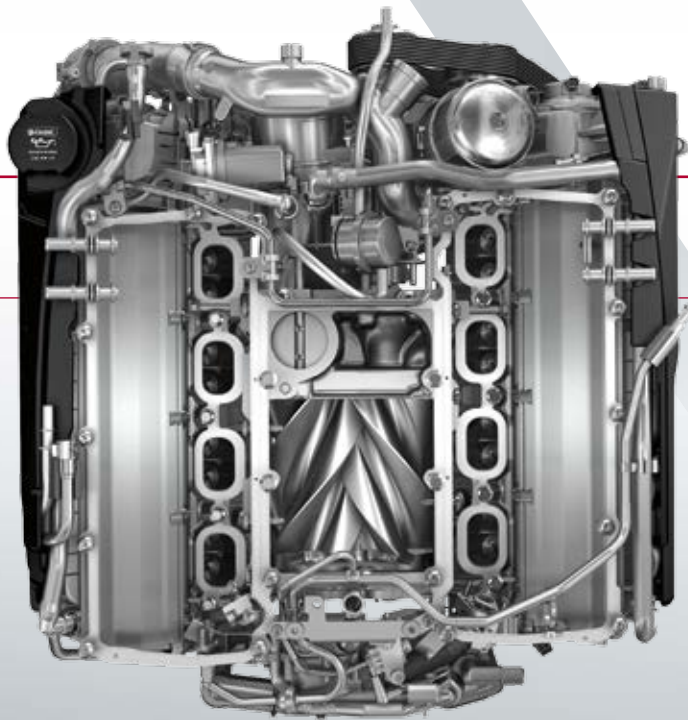

V8 ENGINE

0-100km/h from 4.4 sec*

Lightweight and powerful, this engine features die-cast aluminum blocks to reduce weight. Dual independent variable cam timing optimizes power at any speed. Cleaner, more efficient combustion is achieved by spray-guided direct injection of precisely measured quantities of fuel directly into the centre of the combustion chamber. The 5.0 litre V8 engine is available in one power output - 575HP. The 5.0 litre V8 575HP has been modified to create 517 lb-ft of torque. 0-100km/h acceleration is achieved in 4.4 seconds with a top speed of 280km/h*.

ALL-ALUMINUM BODY



AGILITY ENHANCED

ECONOMY IMPROVED

100% ALUMINUM

The all-aluminum body, the core of its dynamic performance, is stiff, strong and light architecture. Developed using aerospace bonding and riveting techniques, the 100 percent aluminum monocoque body structure of the XJ does not have a single welded joint. With up to 50 percent of the aluminum coming from recycled sources, the XJ leads the way in sustainability.

The power-to-weight ratio improves all aspects of performance without compromising its strength. Acceleration is improved, and because the engine has to work less, it lowers fuel consumption and emissions. Its aluminum construction also enhances ride comfort, handling, agility and feel, connecting the driver seamlessly to the car and the road.

The inherent strength of aluminum and the monocoque construction offer safety benefits too. The lower weight improves braking performance and reduces the kinetic energy involved in almost any impact. Aluminum absorbs significantly more energy than steel when it is deformed and, because there are fewer joints, the XJ strength is increased further still.

VEHICLE SHOWN: 2019 JAGUAR XJL PORTFOLIO IN LOIRE BLUE WITH OPTIONAL EQUIPMENT

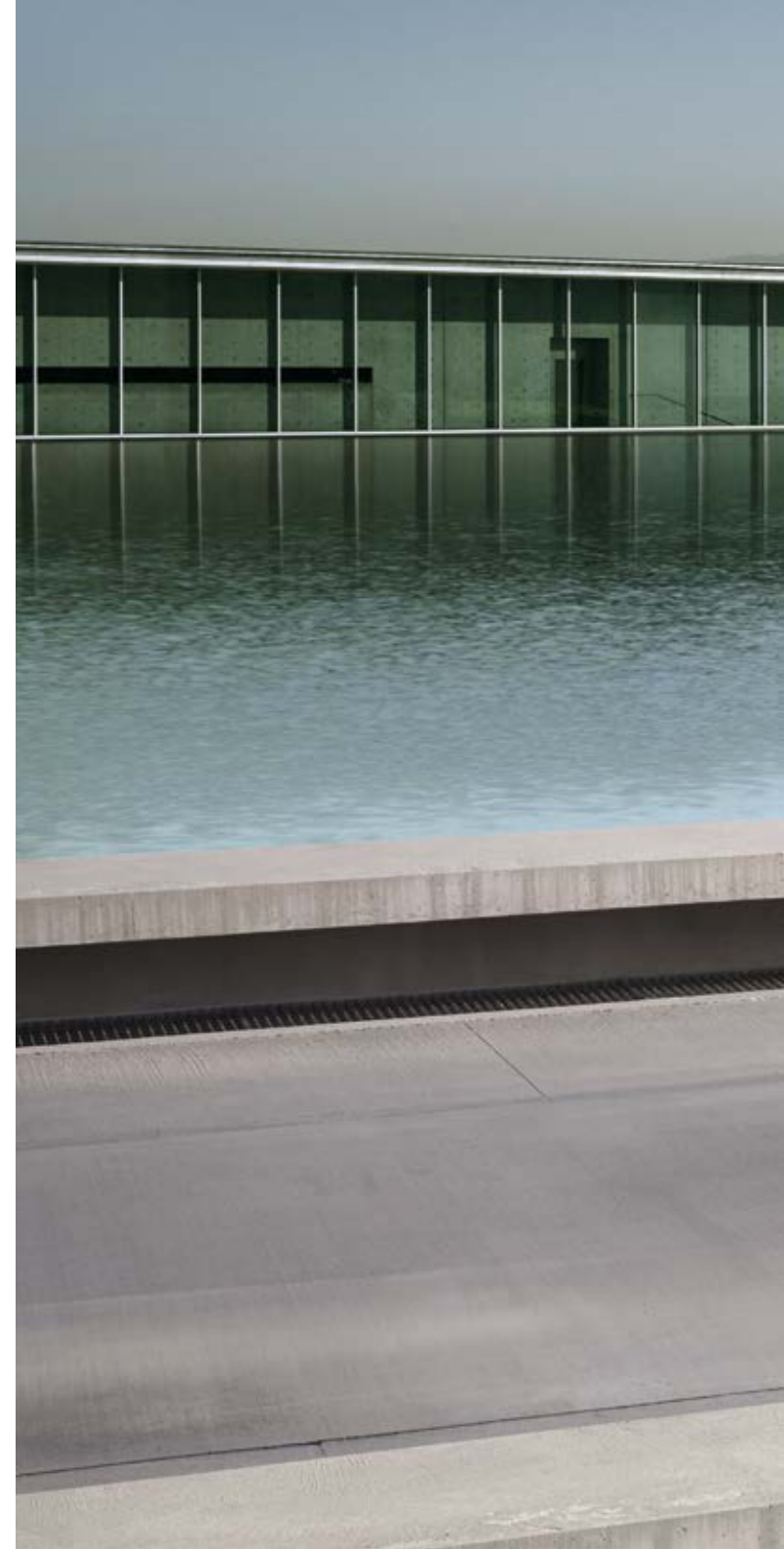



ADVANCED DRIVING DYNAMICS



AIR SUSPENSION SYSTEM

ADAPTIVE DYNAMICS

The XJ delivers the comfort and refinement of a luxury car with the responsiveness and driver involvement of a sports car. Whether you're cornering, navigating uneven surfaces or accelerating, the Adaptive Dynamics system continually monitors the car up to 500 times a second. Working in conjunction with the air suspension it is designed to vary the damping to suit the conditions. These intelligent adjustments are designed to help keep the XJ flat and stable, and to improve control without loss of ride comfort*. In unexpected road and weather conditions, Dynamic Stability Control is designed to react as soon as the system detects the wheels slipping. Trac DSC provides a sportier drive and assists when using snow chains by allowing some slippage or overspin before the system engages*. The XJ also features selectable driving modes for specific performance requirements. In addition to 'Drive' and 'Sport', Dynamic Mode gives more responsive acceleration; Winter Mode is designed to deliver more progressive control in slippery conditions*.

*These features are not a substitute for driving safely with due care and attention and will not function under all circumstances, speeds, weather and road conditions, etc. Driver should not assume that these features will correct errors of judgment in driving. Please consult the owner's manual or your local Jaguar Retailer for more details.

VEHICLE SHOWN: 2019 JAGUAR XJL PORTFOLIO IN CARPATHIAN GREY WITH OPTIONAL EQUIPMENT













XJR575 - THE MOST POWERFUL AND AGILE XJ

 **5.0 LITRE SUPERCHARGED V8** | **ELECTRONIC ACTIVE DIFFERENTIAL**

The breathtaking power and razor-sharp responsiveness of the XJR575 helps deliver new levels of dynamic ability in a luxury sedan. It is the epitome of technology, performance and seductive design – everything Jaguar stands for in the 21st century. This flagship Jaguar has extraordinary performance with a stealthy, purposeful appearance. The 5.0 litre Supercharged V8 engine at its heart generates a formidable 575HP and 517 lb-ft torque, powering the XJR575 to a top speed of 280km/h*.

Capable of accelerating from 0-100km/h in just 4.4 seconds*, the driving dynamics of the XJR575 are assisted by an innovative Electronic Active Differential**. This technology enables fine control of power delivery, designed to enhance traction and limit the occurrence of wheelspin. Working in conjunction with the Dynamic Stability Control and ABS systems, the Electronic Active Differential uses an electric motor, acting on a multi-plate clutch to manage the delivery of torque to the rear wheels**. Full electronic control of the rear differential lock enables the system to apply full locking torque almost instantaneously, allowing the driver to exploit the thrilling performance potential of XJR575.

Subtle exterior design cues optimize the flow of air over and around the car, and signify the sporting intent of this most focused, agile and responsive member of the XJ family. The XJR575 is given even more visual muscularity by a revised rear spoiler, side sills, front hood, splitter and lower air intakes featuring Gloss Black surrounds.

Unique exterior styling includes XJR575 badging and twin hood vents, as well as Red painted brake calipers and 20" 5 split-spoke 'Style 5044' Forged alloy wheels finished in Gloss Black. Also available as a visual enhancement are Satin Corris Grey and Velocity Blue high quality Special Vehicle Operations Premium Palette paint finishes.

*Always follow local speed limits. **These features are not a substitute for driving safely with due care and attention and will not function under all circumstances, speeds, weather and road conditions, etc. Driver should not assume that these features will correct errors of judgment in driving. Please consult the owner's manual or your local Jaguar Retailer for more details.

VEHICLE SHOWN LEFT AND PREVIOUS PAGE: 2019 JAGUAR XJR575 LONG WHEELBASE IN SATIN CORRIS GREY WITH OPTIONAL EQUIPMENT





XJR575 - SPORTING STYLE

SOFT GRAIN LEATHER SPORT SEATS

The XJR575 offers an unrivalled combination of sporting style, contemporary luxury and breathtaking performance. Its sports seats feature adjustable bolsters that provide the driver and passenger with lateral support during hard cornering. They are upholstered in soft grain leather offered in two bold colour combinations, either Ebony with Pimento stitch or Ivory with Ebony stitch. This is complemented with a Carbon Fibre veneer or optional Piano Black veneer. The XJR575 logo appears on the treadplates, dashboard intaglio and is embroidered on the front and rear seats.

INTERIOR SHOWN: 2019 JAGUAR XJR575 LONG WHEELBASE WITH EBONY SOFT GRAIN LEATHER SPORTS SEATS WITH PIMENTO CONTRAST STITCH, EBONY UPPER FACIA, EBONY SUEDECLOTH HEADLINING, CARBON FIBRE VENEER AND EBONY PREMIUM CARPET MATS WITH PIMENTO CONTRAST BINDING WITH OPTIONAL EQUIPMENT

DRIVING TECHNOLOGY ADDED DRIVER ASSISTANCE

ALL SURFACE PROGRESS CONTROL

Standard on every XJ, the Jaguar All Surface Progress Control (ASPC) technology is a low speed cruise control that helps the car to cope with low traction situations. ASPC allows the driver to concentrate on steering the vehicle. Once activated, you use the cruise control buttons to set a 'target' speed of between 3km/h and 30km/h*.

The system then works to achieve and maintain that speed while exerting optimum traction control. ASPC gives XJ drivers added assistance over slippery, loose surfaces, undulating terrain and even while descending a difficult incline**.

*Always follow local speed limits. **These features are not a substitute for driving safely with due care and attention and will not function under all circumstances, speeds, weather and road conditions, etc. Driver should not assume that these features will correct errors of judgment in driving. Please consult the owner's manual or your local Jaguar Retailer for more details.

With any given set of tires, ASPC can accomplish comparable levels of traction. Fitting All Season or Winter tires to XJ can improve capability on slippery surfaces.



GRAVEL



WET GRASS



SNOW/ICE



WET ROAD

ADVANCED DRIVETRAIN TECHNOLOGY



ALL WHEEL DRIVE

OVER 90% TORQUE SPLIT

INTELLIGENT AND ADAPTIVE

The optional Jaguar Instinctive All Wheel Drive® system is continuously variable and intelligent. The rear wheel bias ensures a consistently true Jaguar driving experience. In normal conditions an XJ with the AWD system behaves like a rear wheel drive vehicle but reacts intelligently to road conditions to deliver traction on demand. The AWD system reacts in the blink of an eye, so should the rear wheels start to slip, it is designed to instantly redistribute torque to compensate. Over 90 percent of engine torque can be distributed from the rear wheels to the front wheels to provide optimum traction. It offers a smoother drive with the familiar Jaguar agility and handling*.

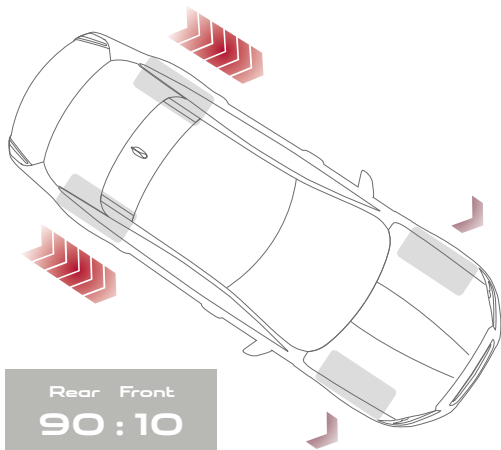

DRY ROAD CONDITIONS

In normal driving conditions, virtually all torque is distributed to the rear wheels providing signature Jaguar rear wheel drive performance.

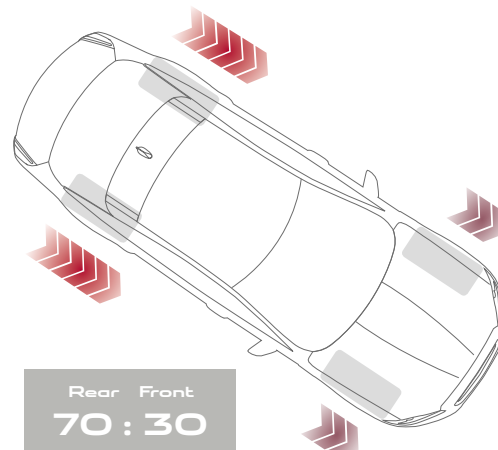

AWD WINTER MODE

At the touch of a button AWD Winter Mode can be selected to distribute 30 percent of the torque to the front wheels and 70 percent of the torque to the rear wheels for improved assistance in difficult conditions*.

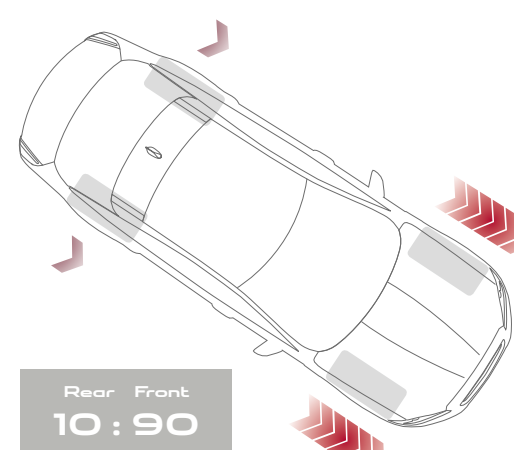

VARIABLE ROAD CONDITIONS

Where road conditions are changeable, over 90 percent of torque can be distributed to the front wheels as required.

*These features are not a substitute for driving safely with due care and attention and will not function under all circumstances, speeds, weather and road conditions, etc. Driver should not assume that these features will correct errors of judgment in driving. Please consult the owner's manual or your local Jaguar Retailer for more details.

VEHICLE SHOWN: 2019 JAGUAR XJL PORTFOLIO IN LOIRE BLUE WITH OPTIONAL EQUIPMENT





Carrer d'Aragó

Safe

Carrer de Numància

20 m

Avinyó

Auto: 5.0km

5341 km

ALBUMS

17:06

FA 4G

Young before your time

Corvidae

Electric Storm



28°C

28°

16°

★ Barcelona



AUTO

A/C

AUTO

TECHNOLOGY INFOTAINMENT

Delivering a wealth of information and entertainment, every XJ is equipped with our Jaguar InControl® infotainment system, Touch Pro. It features intuitive and advanced integrated technologies to ensure everyone can make the most of their trip*.

10" TOUCH PRO

The standard 10" Touchscreen at the heart of the centre console supports swipe and pinch gestures and delivers our richest ever audio-visual entertainment. To enhance the in-car experience, Touch Pro offers customizable homescreens and fast response times as well as voice control. Multi-tasking is also made easy thanks to the Interactive Side Panel*.

*Do not use Jaguar InControl® features under conditions that will affect your safety or the safety of others. Driving while distracted can result in loss of vehicle control.

INTERIOR SHOWN: 2019 JAGUAR XJ PORTFOLIO LONG WHEELBASE SHOWING EBONY SOFT GRAIN PERFORATED LEATHER SEATS WITH OPTIONAL EQUIPMENT

CONNECTIVITY

Jaguar InControl® is our suite of standard and optional features that connects you to your vehicle and links you seamlessly with the outside world. There are a range of packages and options available to choose from. With a selection of apps, even when you're away from your car, some of the InControl features stay with you, making sure the Jaguar experience is more enjoyable than ever*.

STANDARD FEATURES

NAVIGATION PRO

Standard on all models, Navigation Pro allows you to save your favourite places, use pinch and zoom gestures for simple map exploration and display a choice of either 2D or 3D crystal clear map graphics*.

CONNECT PRO PACKAGE

Connect Pro consists of InControl Apps, Remote, Wi-Fi Hotspot and Pro Services. It's designed to enhance your in-car and out-of-car experience, ensuring you and your passengers enjoy the journey while remaining connected to the world*.

INCONTROL APPS

Features a range of Jaguar approved apps that can be connected to the XJ from your smartphone. It ensures convenient use of apps optimized to enhance aspects of your in-car experience. You can also download third-party apps offering a vast range of services*. Applications include:

- Spotify¹ – Access a library of more than 30 million songs with this seamlessly integrated app. Featuring all the same intuitive functionality as the Spotify smartphone app, you can search songs, stations and recommendations, create playlists and access your music in offline mode. Simply log in using your existing Spotify Free or Spotify Premium account.
- Tile² – Helps you find lost or misplaced items in seconds. Attach a tiny Bluetooth tracker Tile to your keys, wallet or bag. The easy-to-use Tile app can then help you find these items should they be misplaced. The app is accessible any time through your vehicle's Touchscreen, allowing you to make sure you have everything you need with you, before you set off on your journey*.

*Do not use Jaguar InControl® features under conditions that will affect your safety or the safety of others. Driving while distracted can result in loss of vehicle control.

¹Please check App Store and Google Play for availability.

²Bluetooth tracker tiles must be purchased separately. 2016 Tile Inc. and the Tile design are trademarks of Tile, Inc.

³When power fold mirrors are specified.



REMOTE

Remote provides information on your vehicle and enables you to interact with it remotely. Compatible with most smartphones, Android Wear™ or the Apple Watch®, this service includes:

- Remote Lock/Unlock – Lock or unlock your doors remotely. Simply press the 'lock' button on the Vehicle Security screen of the Remote smartphone app to single lock the doors and fold in the side mirrors³. Press the 'unlock' button to open your vehicle, unfold the side mirrors, turn on the dipped headlights and cause the hazard lights to flash twice to help you locate your vehicle.
- Remote Climate – Prepare your XJ in advance by pre-heating or pre-cooling the cabin, so that you and your passengers are comfortable from the moment you step inside.
- Beep/Flash – This feature turns on your Jaguar's hazard lights, dipped headlights and sounds an audible alert to help you locate your vehicle.

- Journeys – This opt-in feature can automatically record your trip history including your route and mileage statistics. This information can be exported by email to use for expense reporting and can be imported to a spreadsheet.
- Vehicle Status Check – Check current fuel level and range, and status of door and window position and locks. See the last parked location of the vehicle and find your way back to it with on-foot directions.

Jaguar Optimized Assistance – You can make a direct call to the Jaguar Assistance team by pressing the button on the overhead console or from the Assistance screen within the InControl Remote smartphone app.

SOS Emergency Call – Emergency services will be automatically notified if the airbags are deployed in an accident. For peace of mind, this service is provided for the first ten years from date of registration.

InControl features, options and their availability may vary – check with your Jaguar Retailer for local market availability and full terms. Information and images displayed in relation to the InControl technology, including screens or sequences, are subject to software updates, version control and other system/visual changes depending on options selected. Mobile network connectivity cannot be guaranteed in all locations. InControl Apps and Remote App will need to be downloaded from the Apple/Play Store. All in-car features should be used by drivers only when safe for them to do so. Drivers must ensure they are in full control of the vehicle at all times.

STANDARD FEATURES

PRO SERVICES*

- **Real Time Traffic Information** – Uses live traffic data feeds to give you the most accurate picture of what the traffic is like on the way to your destination*.
- **Online Search** – Wherever you are, you can search the surrounding area for places of interest. The system can access expert destination information, travel tips and inspiration as well as online travel reviews of the local area*.
- **Planning Routes and Door-to-Door Routing** – Before setting off, use the Route Planner app or online to search, save locations or set your destination. The app uses the Cloud to send your destination automatically to your vehicle's navigation screen. Once you've parked, the Route Planner app will guide you to your destination – a true door-to-door experience which includes public transportation options*.
- **Share ETA** – You can share your estimated time of arrival so your selected contact(s) will know exactly when you will arrive, as calculated by the navigation guidance system. If you're running late, Share ETA can then send automatic updates via text messages or email, without any further action from you*.
- **Satellite View** – When you want to get the context of your surroundings from overhead, simply switch to satellite view*.
- **Commute Mode** – Allows the system to learn your commutes and automatically advises you of the expected travel time based on live and historical traffic movements without you having to input a destination. The system learns the routes you take for a given destination and then advises which of those is the quickest. The feature can be turned on and off dependent on driver preference.

- **Parking Service** – As you approach your destination, you can see where parking is available. Simply tap on the parking and the navigation system updates to direct you to it.
- **Online Routing** – While you're on your way to a destination the system monitors live traffic conditions and takes into account typical traffic patterns for that time of day, keeping you on the optimum route.
- **Safety Cameras** – Alerts you to the location of accident black spots monitored by safety cameras.
- **Fuel Prices** – When you're going to fill up, the Fuel Price service not only finds gas stations along your route, it also enables you to compare fuel prices so you can keep your costs down.

WI-FI HOTSPOT**

Wi-Fi Hotspot gives you the option to create a strong 4G hotspot using the car's antenna when you fit a SIM card. Connect up to eight devices to read emails, browse the web and download content.

*Do not use Jaguar InControl® features under conditions that will affect your safety or the safety of others. Driving while distracted can result in loss of vehicle control. **The Wi-Fi Hotspot is intended for passenger use only. InControl features may require an additional subscription with separate terms and conditions.

iPhone® is a registered trademark of Apple Inc., registered in the US and other countries. Please ensure iPhone compatibility is reviewed with your local Jaguar Retailer. Remote contains subscription services that can be extended after the initial term advised by your Jaguar Retailer. InControl features, options and their availability may vary – check with your Jaguar Retailer for local market availability and full terms. Information and images displayed in relation to the InControl technology, including screens or sequences, are subject to software updates, version control and other system/visual changes depending on options selected. Mobile network connectivity cannot be guaranteed in all locations. InControl Apps and Remote App will need to be downloaded from the Apple/Play Store. All in-car features should be used by drivers only when safe for them to do so. Drivers must ensure they are in full control of the vehicle at all times.

ALBUMS

14:56

Young before your time
Corvidae

4G

Electric Storm



28°C 28°
16°

< ★ New York >



AUDIO

A vehicle's cabin is the ideal place within which to experience your personal choice of music and Jaguar XJ has the option of two different audio systems to bring your music to life:



SIRIUSXM® SATELLITE RADIO AND HD RADIO™

Standard on all XJ models, SiriusXM® Satellite Radio* and HD Radio technology offers improved sound quality, and a wide choice of stations and entertainment.

MERIDIAN™ SURROUND SOUND SYSTEM¹

All the fullness and clarity of a live performance delivered through an arrangement of 18 front, side and rear speakers plus two subwoofers – seamlessly brought together using Trifield™ technology. Exclusive to Meridian, Trifield perfectly blends the centre and surround channels with left and right channels ensuring an optimum, consistent sound experience for each passenger.

MERIDIAN REFERENCE SOUND SYSTEM²

The ultra-premium Meridian Reference 1300W Sound System uses 24 speakers and 2 subwoofers. Employing Psychoacoustics, it produces sounds that are so true to life they are perceived by the brain as the real thing.

*A 3-month trial subscription to the SiriusXM Select + package is included with the vehicle, which gives you access to 130 channels of premium programming. Plus you can stream SiriusXM on your computer, smartphone or tablet – it's included in your trial. If you decide to continue service after your trial, the subscription plan you choose will automatically renew thereafter and you will be charged according to your chosen payment method at then-current rates. Fees and taxes apply. To cancel you must call SiriusXM at 1-888-539-7474. See the SiriusXM Customer Agreement for complete terms at siriusxm.ca. All fees and programming are subject to change.

¹Standard Feature. ²Not available on XJR575, optional on all other models.

MERIDIAN™

Formed in 1977 in Cambridgeshire, England, Jaguar’s audio partner Meridian has pioneered many firsts including active speakers and the world’s first digital surround sound processor. Meridian’s audio technology input has helped ensure that the Jaguar XJ is one of the most superb spaces. Meridian Cabin Correction technology was utilized to analyze cabin shape, acoustics and resonance characteristics in order to help remove unwanted sounds. The advanced algorithm ensures that the rhythm, punch and timing of any piece of music are heard precisely how the artist intended, providing a consistently exceptional quality audio experience for all passengers in the vehicle.

	UNIQUE MERIDIAN TECHNOLOGY	SPEAKERS AND SUBWOOFERS	WATTS
MERIDIAN™ SURROUND SOUND		18+2	825
MERIDIAN™ REFERENCE SOUND		24+2	1,300



DIGITAL SIGNAL PROCESSING

Brings all elements of the audio system together as one, for performance that would otherwise require significantly larger speakers.



MERIDIAN CABIN CORRECTION

The advanced algorithm of Meridian’s Cabin Correction tailors the sound experience to the precise acoustics of the XJ interior.



MERIDIAN DIGITAL DITHER SHAPING

To maintain the quality of musical recordings, they are converted into a common digital format. Meridian Digital Dither Shaping ensures that digital signal conversions are made smoothly and seamlessly, preserving the finest details of the audio performance. The result is authentic musical conversion, evoking the emotions of the original recording.



TRIFIELD

Exclusive to Meridian, Trifield blends the centre and surround channels seamlessly with left and right channels, delivering a consistent, concert-like experience for all occupants.



CONVERSATION ASSIST

Conversation Assist, included as standard with the Meridian Reference 1,300W Sound System, allows the driver or front seat passenger to talk with ease to passengers in the rear of the car, and vice versa. Microphones above each seat reinforce the occupants’ voices via the audio system’s speakers, making it much easier for everyone to be heard.

Meridian is a trademark of Meridian Audio Ltd.
Trifield and the "three fields" device is a trademark of Trifield Productions Ltd.
Features and their availability may differ by vehicle specification and market.

ASSISTANCE AND EFFICIENCY

DRIVER ASSISTANCE

The XJ is equipped with an array of standard and optional Driver Assist Systems dependent on the model chosen. All are designed to make driving easier.

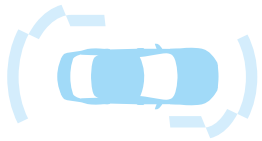

360° PARKING AID¹

360° Parking Aid uses ultrasonic sensors to the front, rear and sides of the vehicle to alert you to the proximity of objects when parking or exiting from a spot*.



ADAPTIVE FRONT LIGHTING

Adaptive Front Lighting adapts to steering inputs to cast a deeper beam into corners, while its Auto High Beam Assist can detect oncoming vehicles and automatically selects high or dipped beam as appropriate*.



AUTONOMOUS EMERGENCY BRAKING²

Should a potential collision with another vehicle be detected, the XJ gives an audible forward collision warning. Visual warnings follow. If the driver takes no action, the system applies the brakes to help reduce the severity of the possible impact**. This system also includes pedestrian sensing*.



TRAFFIC SIGN RECOGNITION AND ADAPTIVE SPEED LIMITER

Traffic Sign Recognition technology can detect current speed limit signs to display them on the Interactive Driver Display. This smart system is also aware of local and conditional speed limits. When activated, our Adaptive Speed Limiter uses Traffic Sign Recognition information to adjust your car's speed accordingly*.

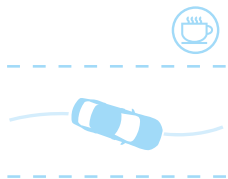

DRIVER CONDITION MONITOR²

Driver Condition Monitor detects if you're starting to feel drowsy or fatigued - giving you an early warning when you need to take a break*.



PARK ASSIST^{1 2}

Park Assist makes parking easier. The system works for both parallel and perpendicular parking and is designed to automatically steer the XJ into space while the driver operates the pedals*. The system also assists in pulling out of a parallel space.

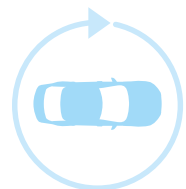

360° SURROUND CAMERA¹

Provides a 360° exterior view via the Touchscreen, helping with various manoeuvres from parking by a curb, to getting in and out of tight spaces*.



ADAPTIVE CRUISE CONTROL WITH QUEUE ASSIST¹

Adaptive Cruise Control with Queue Assist is designed to keep your vehicle a set distance from the one in front should it slow or stop when you're cruising on the highway or travelling in slow-moving traffic. Should the vehicle in front stop completely, the system can provide assistance to reduce the stopping distance. Once the traffic moves, simply touch the accelerator and Adaptive Cruise Control will resume following the car in front. The system can be activated from 16km/h up to highway speeds*.

*These features are not a substitute for driving safely with due care and attention and will not function under all circumstances, speeds, weather and road conditions, etc. Driver should not assume that these features will correct errors of judgment in driving. Please consult the owner's manual or your local Jaguar Retailer for more details. Park Assist will only steer out of parallel spaces not perpendicular. **Please note that if any action is taken, even minimal steering, the AEB system will assume the driver resumed control of the vehicle and the system will automatically disengage.

¹Optional feature. ²Available on Rear Wheel Drive (RWD) models only.

For more details on feature availability refer to pages 62-67 or configure your vehicle at jaguar.ca

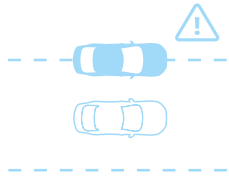

LANE DEPARTURE WARNING²

Lane Departure Warning can help make long trips more enjoyable. It senses when your car is unintentionally drifting out of your lane, and notifies you with a visual alert and a gentle vibration of the steering wheel*.

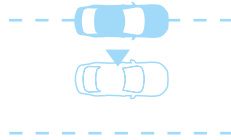

LANE KEEP ASSIST²

Working in conjunction with Lane Departure Warning, Lane Keep Assist can sense when your car is unintentionally drifting out of your lane, and is designed to gently steer you back*.



BLIND SPOT MONITOR

Blind Spot Monitor is designed to warn you of vehicles in, or quickly approaching your blind spot. When a vehicle is detected, a small warning light will illuminate in the corresponding side mirror. If you indicate in the direction of the obstacle, the warning light will flash to highlight potential danger*.

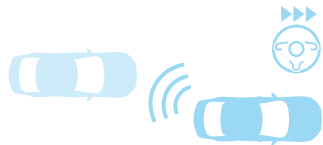

BLIND SPOT ASSIST²

If your vehicle detects another car in your blind spot when you begin to change lanes, this system is designed to provide precisely calculated steering torque - guiding your car away from the approaching vehicle*.



REVERSE TRAFFIC DETECTION

Reverse Traffic Detection is particularly useful when reversing out of a parking spot, the system is designed to warn you of vehicles, pedestrians or other hazards, approaching from either side of your vehicle. It will alert you with both audio and visual warnings even when the view is obstructed*.

EFFICIENT TECHNOLOGIES

 **STOP/START* TECHNOLOGY** | **CLEAN TECHNOLOGIES**

We are determined to do more with less. That is why the XJ uses a range of technologies to help reduce fuel consumption and CO₂ emissions, all while staying true to the dynamic nature of Jaguar.



STOP/START TECHNOLOGY

The XJ engines come with Stop/Start technology. It shuts down the engine when you come to a complete halt and restarts the engine immediately when required, helping to save fuel, especially during city driving.

*These features are not a substitute for driving safely with due care and attention and will not function under all circumstances, speeds, weather and road conditions, etc. Driver should not assume that these features will correct errors of judgment in driving. Please consult the owner's manual or your local Jaguar Retailer for more details.



ELECTRIC POWER ASSISTED STEERING (EPAS)

The next generation Electric Power Assisted Steering (EPAS) offers outstanding feedback, control and immediate power assistance*. Electrically driven, it's only active on demand which helps to save fuel. Only available on rear wheel drive vehicles.



AERODYNAMICS

The highly efficient shape of the XJ is the result of hundreds of thousands of hours of Computational Fluid Dynamics testing. Jaguar created one of the world's most advanced automotive virtual testing labs, honing the XJ shape through virtual wind tunnels to slice through wind resistance.



ALUMINUM ARCHITECTURE

The All-Aluminum architecture of the XJ makes it a lighter vehicle, meaning less fuel is needed to move it and consequently creating lower emissions.





XJ50 - CELEBRATING THE PAST, LOOKING TO THE FUTURE

For 50 years, the XJ has been synonymous with innovation, style and attention to detail. The special edition XJ50 celebrates this triumph of British design and craftsmanship. With an array of advanced driving technologies, XJ50 delivers the refinement of a luxury car with the responsiveness and driver involvement of a sports car. Subtle chrome XJ50 badging on the side vents and trunk lid distinguish this flagship Jaguar from its counterparts.

VEHICLE SHOWN: 2019 JAGUAR XJ50 LONG WHEELBASE IN LOIRE BLUE WITH OPTIONAL EQUIPMENT



JAGUAR

FLAWLESS CRAFTSMANSHIP SINCE 1968

The XJ50 is available in four specially selected exterior colours - Fuji White, Santorini Black, Rosello Red and Loire Blue. Complementing the elegant and sporty exterior are the new and exclusive to the XJ50 5 split-spoke 'Style 5045' alloy wheels with a Gloss Black and Diamond Turned finish. On the inside, unique design features and meticulous attention to detail set the XJ50 apart. Illuminated XJ50 branded treadplates draw you into a cabin that honours style and elegance. The dashboard intaglio and front armrest also feature the XJ50 logo. Delightful to touch, soft grain leather with Diamond sew pattern and twin-needle contrast stitching covers the seats, instrument panel and doors. Headrests embossed with the Jaguar leaper and a hand-crafted Gloss Shadow Walnut veneer add to the luxurious ambience.

VEHICLE SHOWN: 2019 JAGUAR XJ50 LONG WHEELBASE IN LOIRE BLUE WITH OPTIONAL EQUIPMENT



PERSONALIZATION THE XJ - YOUR CHOICE

 Configure your vehicle at jaguar.ca



CHOOSE YOUR ENGINE

Page 58

Select a powerful XJ engine to suit your driving style.

CHOOSE YOUR MODEL & OPTIONS

Page 60

Compare the wealth of standard features and options on the XJ models.

CHOOSE YOUR COLOUR

Page 68

Express your individuality with one of the stunning XJ exterior colours.

CHOOSE YOUR WHEELS

Page 70

Add the personal finishing touch to your new XJ, and complement its stunning style, with a set of beautifully designed alloy wheels.

CHOOSE YOUR INTERIOR

Page 72

There's a wide selection of premium materials, leathers, veneers and finishes for every personal taste.

CHOOSE YOUR JAGUAR GEAR

Page 84

Really make it yours by adding style, practicality and versatility with official XJ Gear Accessories from your local Jaguar Retailer.

1 CHOOSE YOUR ENGINE

 Configure your vehicle at jaguar.ca

V6 ENGINE

3.0 LITRE V6 SUPERCHARGED GAS AWD

MAXIMUM POWER 340HP

MAXIMUM TORQUE 332 lb-ft

ACCELERATION 0-100km/h 6.4 seconds*

TOP SPEED 195km/h

XJ R-SPORT, XJ & XJL PORTFOLIO, XJ50 LWB



0-100 KM/H

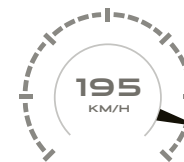

TOP SPEED KM/H

*Always follow local speed limits.

 **V8 ENGINE**

5.0 LITRE V8
SUPERCHARGED GAS RWD

MAXIMUM POWER 575HP

MAXIMUM TORQUE 517 lb-ft

ACCELERATION 0-100km/h in 4.4 seconds*

TOP SPEED 280km/h

XJR575 LWB



0-100 KM/H



TOP SPEED KM/H

2 CHOOSE YOUR MODEL

 Configure your vehicle at jaguar.ca

LUXURY



XJ & XJL PORTFOLIO

KEY FEATURES

All-Wheel Drive
19" alloy wheels
Full LED headlights with Adaptive Lighting and Automatic High Beam Assist*
Panoramic Glass Roof - Tilt/Slide Front Section with Electric Blind
18-way power front seats with 4-way lumbar adjust
Front seats with five massage programs
Soft grain leather active-ventilated heated and cooled front and rear seats

10" Touchscreen
Touch Pro™ with connected Navigation**
12.3" Interactive Driver Display
Meridian™ Surround Sound System
Blind Spot Monitor and Reverse Traffic Detection*
Four-zone Climate Control
Front and Rear Parking Aid*
All Surface Progress Control*
Twin oval exhausts



XJ50

KEY FEATURES (IN ADDITION TO 'XJ & XJL PORTFOLIO')

Unique 20" 5 split-spoke 'Style 5045' alloy wheels with Gloss Black Diamond Turned finish
Chrome XJ50 side power vents
XJ50 rear badging
Illuminated XJ50 branded treadplates
Exclusive XJ50 intaglio
XJ50 embossed centre armrest
Gloss Shadow Walnut veneer

Unique XJ50 front and rear bumpers with Black grille mesh
Aluminium gearshift paddles
Bright metal foot pedals
Illuminated air vents
360° Surround Camera System

*These features are not a substitute for driving safely with due care and attention and will not function under all circumstances, speeds, weather and road conditions, etc. Driver should not assume that these features will correct errors of judgment in driving. Please consult the owner's manual or your local Jaguar Retailer for more details.

**Do not use Jaguar InControl® features under conditions that will affect your safety or the safety of others. Driving while distracted can result in loss of vehicle control.

> SPORT



XJ R-SPORT

KEY FEATURES

All Wheel Drive
19" alloy wheels
'R-Sport' exterior with Black mesh grill, side sills and rear spoiler
Full LED headlights with Adaptive Lighting and Automatic High Beam Assist*
Panoramic Glass Roof - Tilt/Slide Front Section with Electric Blind
14-way power front seats with 4-way lumbar adjust
Soft grain leather active-ventilated heated and cooled front and rear seats

10" Touchscreen
Touch Pro™ with connected Navigation**
12.3" Interactive Driver Display
Meridian™ Surround Sound System
Blind Spot Monitor and Reverse Traffic Detection*
Front and Rear Parking Aids*
All Surface Progress Control*
Twin oval exhausts



XJR575

KEY FEATURES (IN ADDITION TO XJL PORTFOLIO)

Rear Wheel Drive
20" alloy wheels with Gloss Black finish
XJR575 treadplates
Gloss Black grille with Gloss Black surround
Gloss Black side window surround
Gloss Black side power vents
Red painted brake calipers with Jaguar Script
XJR575 hood vents
Body-coloured rear valance with Gloss Black insert
Unique Sports Exhaust with quad pipes
Aluminium gearshift paddles
Illuminated air vents
Sport Seats with "575" badging
Carbon Fibre engine cover
Carbon Fibre trim finisher
360° Parking Aid*
Park Assist*
Red brake calipers
Autonomous Emergency Braking
18-way power front sport seats with 575 embossing

2 CHOOSE YOUR OPTIONS

 Configure your vehicle at jaguar.ca

KEY STANDARD & OPTIONAL FEATURES	XJ R-SPORT	XJ & XJL PORTFOLIO	XJ50 LWB	XJR575 LWB
TRANSMISSION, STEERING & DYNAMIC FEATURES				
All Wheel Drive	●	●	●	—
Rear Wheel Drive	—	—	—	●
8-speed ZF electronic automatic transmission with Jaguar Sequential Shift™ with Drive and Sport Modes*	●	●	●	●
Steering wheel mounted shift paddles	●	●	●	●
JaguarDrive Control™ - with Normal, Winter & Dynamic Modes*	●	●	●	●
JaguarDrive Selector™ rotary gear selector	●	●	●	●
STEERING				
Power-assisted, speed sensitive, variable ratio, rack and pinion steering	●	●	●	●
Electric Power Assisted Steering (EPAS)*	●	●	●	●
Hydraulic Power Assisted Steering (AWD models only)	●	●	●	—
SUSPENSION				
Adaptive Dynamics*	●	●	●	●
Active Differential Control ¹	—	—	●	●
Suspension - front coils, rear air (self-levelling) - Standard	●	●	●	—
Suspension - front coils, rear air (self-levelling) - 'R' tuned	—	—	—	●
All Surface Progress Control (ASPC)*	●	●	●	●
BRAKES & STABILITY CONTROL				
Anti-Lock Braking System (ABS)	●	●	●	●
Emergency Brake Assist (EBA)*	●	●	●	●
Dynamic Stability Control (DSC) with Trac DSC mode*	●	●	●	●
Electric Parking Brake (EPB) drive away release	●	●	●	●
Red brake calipers with 'JAGUAR' script	—	—	—	●
EXHAUST				
Standard Exhaust	●	●	●	—
Sport Exhaust	—	—	—	●

● Standard ○ Optional — Not available

¹V8 engine only.

P2 Illumination Package P3 Premium Rear Seat Package. See page 67 for package details.

SAFETY & SECURITY

SAFETY & SECURITY	XJ R-SPORT	XJ & XJL PORTFOLIO	XJ50 LWB	XJR575 LWB
SAFETY				
Active head restraints with front seat whiplash protection	●	●	●	●
Airbags: Dual-stage front airbags and side airbags for front occupants**	●	●	●	●
Airbags: Side curtain airbags for front and rear**	●	●	●	●
Belt minder system (front and rear)	●	●	●	●
Safety belt pretensioners for front seating positions	●	●	●	●
Lower Anchors and Tethers for Children (LATCH)	●	●	●	●
Child seat tethered-anchorage	●	●	●	●
Three-point seatbelts at all 5 seating positions	●	●	●	●
Tire Pressure Monitoring System (TPMS)	●	●	●	●
Trunk entrapment release	●	●	●	●
SECURITY				
Security system - alarm and engine immobilizer	●	●	●	●
Remote control locking with driveaway locking	●	●	●	●

*These features are not a substitute for driving safely with due care and attention and will not function under all circumstances, speeds, weather and road conditions, etc. Driver should not assume that these features will correct errors of judgment in driving. Please consult the owner's manual or your local Jaguar Retailer for more details. ** Please remember that the safety belts in a vehicle constitute the primary protection system for driver and passengers in collisions. Airbags are not designed to deploy in all collisions. The airbag Supplemental Restraint System (SRS) is a supplement to the safety belts and is designed to work as a system with the safety belts. Although airbags provide additional protection, airbags without safety belts do not provide optimal protection in a crash. Always wear your safety belts. Children younger than 13 years old should always be properly restrained in a back seat, away from airbags. Never place an infant seat in the front seat.

DRIVERS AIDS

	XJ R-SPORT	XJ & XJL PORTFOLIO	XJ50 LWB	XJR575 LWB
Cruise Control with Automatic Speed Limiter (ASL)*	●	●	●	●
Adaptive Cruise Control (ACC) with Forward Alert and Intelligent Emergency Brake, Forward Alert and Queue Assist*	○	○	○	○
Blind Spot Assist and Reverse Traffic Detection (RWD models only)*	—	—	—	●
Blind Spot Monitor and Reverse Traffic Detection (AWD models only)*	●	●	●	—
Traffic Sign Recognition and Adaptive Speed Limiter*	●	●	●	●
Front and Rear Parking Aids*	●	●	●	●
360° Parking Aid	○	○	○	●
Rear View Camera*	●	●	—	●
360° Surround Camera*	○	○	●	○
Park Assist – Parallel, Perpendicular and Exit* (RWD models only)	—	—	—	●
Lane Departure Warning and Lane Keep Assist* (RWD models only)	—	—	—	●
Driver Condition Monitor* (RWD models only)	—	—	—	●

CONVENIENCE FEATURES

	XJ R-SPORT	XJ & XJL PORTFOLIO	XJ50 LWB	XJR575 LWB
Approach Illumination (automatic via remote)	●	●	●	●
Door puddle lights (front and rear)	●	●	●	●
Rear business tables (Long Wheelbase models only)	—	P3	P3	—
Front ashtray and lighter	NCO	NCO	NCO	NCO
Garage-door/entry-gate opener	●	●	●	●
Illuminated rear vanity mirrors (Long Wheelbase models only)	—	●	●	●
Jaguar Smart Key System™ with Keyless Entry and start	●	●	●	●
Rain-sensing, variable intermittent dual windshield wipers	●	●	●	●
Rear LED reading lights	P2	●	●	●
Soft door close	●	●	●	●
Sunvisors – Driver and front passenger with illuminated vanity mirrors	●	●	●	●

2 CHOOSE YOUR OPTIONS

 Configure your vehicle at jaguar.ca

EXTERIOR FEATURES		XJ R-SPORT	XJ & XJL PORTFOLIO	XJ50 LWB	XJR575 LWB
BODY EXTERIOR APPEARANCE					
Front grille	Chrome mesh with Chrome surround	—	●	—	—
	Black mesh with Chrome surround	●	—	●	—
	Black mesh with Gloss Black surround	—	—	—	●
Front bumper	Sculpted with Gloss Black finish	—	—	—	●
Blades - front lower grilles - Chrome		●	●	—	—
3-piece lower front splitter	Body coloured outer, back centre section	●	—	●	●
Window surround finishers	Gloss Black	—	—	—	●
	Chrome	●	●	●	—
Hood vents		—	—	—	●
Extended side sills		●	—	—	●
Rear trunklid spoiler		●	—	—	●
Tailpipes	Twin oval with Chrome finisher	●	●	●	—
	Quad with Chrome finisher	—	—	—	●
	Gloss Black	●	—	—	—
Rear valance	Gloss Black with Chrome blade	—	●	—	—
	Body coloured with Black panel insert	—	—	—	●
	Body coloured with Chrome Blade	—	—	●	—

EXTERIOR FEATURES		XJ R-SPORT	XJ & XJL PORTFOLIO	XJ50 LWB	XJR575 LWB
EXTERIOR BADGING					
Front grille - 'R'		—	—	—	●
Side power vents	Chrome with no script	—	●	—	—
	Chrome side with Black mesh - 'R-Sport' script Gloss Black with Black mesh	●	—	—	—
	Chrome with 'XJ50' script	—	—	●	—
Centre trunk lid - Jaguar leaper and Jaguar script	Gloss Black side with Black mesh	—	—	—	●
		●	●	●	●
	'AWD' w/AWD models only	●	●	●	—
Trunk right side	Powertrain - '3.0'	●	●	●	—
	'575R'	—	—	—	●
	'XJ50'	—	—	●	—
	Nameplate 'XJ' or 'XJL' as appropriate	●	●	—	●
Nameplate debadging - Removes 'XJ' and displacement badge	○	○	—	—	
GLASS					
Rear window - heated with timer		●	●	●	●
Solar attenuating glass		●	●	●	●
Acoustically laminated glass (windshield and front door glass)		●	●	●	●
Panoramic Glass Roof - Tilt/Slide Front Section with Electric Blind		●	●	●	●
Heated front windshield with timer		○	○	○	○
LIGHTS					
Full LED headlights with LED signature		●	●	●	●
Adaptive Front Lighting and Auto High Beam Assist		●	●	●	●
Light Emitting Diode (LED) tail lights		●	●	●	●

● Standard ○ Optional — Not available

P1 Comfort Package P2 Illumination Package P3 Premium Rear Seat Package See page 67 for package details.

INTERIOR FEATURES

	XJ R-SPORT	XJ & XJL PORTFOLIO	XJ50 LWB	XJR575 LWB
Jaguar premium analogue dash clock	●	●	●	●
Intaglio – Gloss Black with 'JAGUAR' script	●	●	–	–
Intaglio – Gloss Black with '575' script	–	–	–	●
Intaglio – Gloss Black with 'XJ50' script	–	–	●	–
White and Phosphor Blue halo illumination and interior lighting	●	●	●	●
JaguarSense™ overhead light operation and glove box opening	●	●	●	●
Illuminated air vents front and rear	P2	P2	●	●
Bright metal foot pedals	–	–	●	●
Carbon Fibre engine cover	–	–	–	●
CLIMATE CONTROL				
Dual-zone automatic Climate Control with air filtration, humidity sensing and dual zone temperature control for driver and front passenger	●	–	–	–
Four-zone automatic Climate Control with air filtration, humidity sensing and four zone temperature control for driver, front passenger and independent control for left and right rear passengers	P1	●	●	●
Air Quality Sensor with auto recirculation	●	●	●	●
MIRRORS & WINDOWS				
Auto-dimming interior rear view mirror	●	●	●	●
Exterior mirrors – electric adjustment, heated, auto-dimming, power-folding with courtesy puddle lights and memory function	●	●	●	●
Front and rear electric windows with one-touch open/close and anti-trap	●	●	●	●
WINDOW SUNBLINDS				
Electrically operated rear window sunblind	P1	●	●	●
Electric rear side window sunblinds (Long wheelbase models only)	–	●	●	●
FOOTWELLS				
Premium front and rear floor mats – edged in interior contrast colour	●	●	●	●
Stainless steel sill tread plates – Jaguar script	●	●	–	–
Stainless steel sill tread plates – XJR575 script	–	–	–	●
Stainless steel sill tread plates – Jaguar script, illuminated	P2	P2	–	–
Stainless steel sill tread plates – XJ50 script, illuminated	–	–	●	–
Courtesy footwell lights – front and rear	●	●	●	●

STEERING WHEEL & CONTROLS

	XJ R-SPORT	XJ & XJL PORTFOLIO	XJ50 LWB	XJR575 LWB
Steering column with electric adjustment for height reach with entry and exit tilt	●	●	●	●
Heated leather steering wheel: 3-spoke soft grain leather heated with Jaguar Sequential Shift™ paddles and remote controls for audio system, cruise control, Bluetooth* telephone connectivity	●	●	–	–
Heated leather steering wheel: 3-spoke soft grain leather heated with Aluminum Jaguar Sequential Shift™ paddles and remote controls for audio system, cruise control, Bluetooth* telephone connectivity	–	–	●	–
Heated leather steering wheel: 3-spoke soft grain leather heated with 'R' logo to the bottom spoke with Aluminum Jaguar Sequential Shift™ paddles and remote controls for audio system, cruise control, Bluetooth* telephone connectivity	–	–	–	●
Leather and wood steering wheel: 3-spoke wood and leather heated steering wheel with Jaguar Sequential Shift™ paddles and remote controls for audio system, cruise control, Bluetooth* telephone connectivity	○	○	–	–
Three-flash lane change indicators	●	●	●	●
SEATING				
14-way power front seats (forward/rear, cushion height, back seat recline and cushion tilt – plus manual headrest)	●	–	–	–
18-way power front seats (forward/rear, cushion height, back seat recline, cushion tilt, powered headrest and 2 ways adjustable bolsters)	P1	●	●	–
18-way power front sport seats – Quilted soft grain leather with embossed '575' script	–	–	–	●
4-way lumbar adjust – Driver and Passenger	●	●	●	●
Front Seat Massage – includes 5 massage modes and 5 levels of intensity	P1	●	●	–
Heated and cooled active ventilated front seats	●	●	●	●
Rear seat, two individual seats with back movement and rear seat back upper articulation including Massage with 3 modes (Long Wheelbase models only)	–	P3	P3	–
Headrest – Embossed leaper	●	●	●	–
Seat back rest front and rear – Embossed '575' script	–	–	–	●
Winged headrests – front and rear (Removes embossed leaper). Long Wheelbase models only	–	P3	P3	–
Front passenger seat away (fore/aft) side seat switch for driver control (Long Wheelbase models only)	–	P3	P3	–
Full control of front passenger seat from rear passenger seat controls (passenger side only) Long Wheelbase models only	–	P3	P3	–
Remote control of all seat positions from Touchscreen (Long Wheelbase models only)	–	P3	P3	–
Rear seat footrests (drop in) Long Wheelbase models only	–	P3	P3	–
Memory function with 3 settings for driver seat, exterior mirrors and steering column	●	–	–	–
Memory function with 3 settings for driver and passenger seats, exterior mirrors and steering column	P1	●	●	●
Rear seat memory including showroom positioning for seat default positioning (Long Wheelbase models only)	–	P3	P3	–

2 CHOOSE YOUR OPTIONS

 Configure your vehicle at jaguar.ca

INTERIOR FEATURES CONTINUED

	XJ R-SPORT	XJ & XJL PORTFOLIO	XJ50 LWB	XJR575 LWB
INTERIOR TRIM				
Soft grain perforated leather seats front and rear with contrast stitch and piping and leaper embossed in headrests	●	—	—	—
Quilted soft grain perforated leather seats front and rear with contrast stitch and leaper embossed in headrests	—	●	●	—
Quilted soft grain perforated leather seats front and rear with contrast stitch and embossed '575' seat back (No leaper in headrest)	—	—	—	●
Soft feel stitched and tailored upper fascia, door top roll and armrest and centre console lid with twin needle stitching	●	—	—	—
Soft grain leather stitched and tailored upper fascia, door top roll, door pannier, door armrest and centre console lid with twin needle stitching	—	●	●	—
Soft grain leather stitched and tailored upper fascia, IP binnacle, door top roll, door pannier, door armrest and centre console lid with twin needle stitching	—	—	—	●
Morzine headlining	●	—	—	—
Jaguar suedecloth premium headlining	—	●	●	●
STORAGE				
Front centre console with illuminated storage compartment, auxiliary power socket and armrest	●	●	●	●
Twin front cupholders (32oz) with sliding cover	●	●	●	●
Rear centre armrest with twin cupholders (20oz)	●	●	●	●
Rear centre armrest with rear seat control switch panel and RSE remote storage (Long Wheelbase models only)	—	P3	P3	—
Rear coat hooks	●	●	●	●
TRUNK				
Power trunk lid with adjustable opening height	●	●	●	●
Trunk latch finishing plate	●	●	●	●
VENEER TRIM				
Gloss Burr Walnut	●	●	—	—
Gloss Figured Ebony	○	○	—	—
Gloss Shadow Walnut	—	—	●	—
Piano Black	○	○	—	○
Carbon Fibre	○	○	—	●

INFORMATION, COMMUNICATION & ENTERTAINMENT

	XJ R-SPORT	XJ & XJL PORTFOLIO	XJ50 LWB	XJR575 LWB
MULTIMEDIA				
Virtual Instruments - 12.3" Interactive Driver Display	●	●	●	●
Touch Pro™ - 10" Touchscreen - controls audio, Navigation, Bluetooth®, climate control. Solid State Drive-based Navigation*	●	●	●	●
InControl Apps™ enables use of optimized 3rd party smartphone apps installed on a phone through the vehicle's Touchscreen*	●	●	●	●
Meridian™ 825W 7.1 Channel Digital Surround Sound System plus Meridian™ Trifield mode, 20 speakers including 2 subwoofers, separate DSP, Audyssey MultEQ and Meridian™ Cabin Correction	●	●	●	●
Meridian™ 1,300W Reference System 7.1 Surround Sound System	○	○	○	—
HD Radio™	●	●	●	●
SiriusXM® Satellite Radio (3 mo. Complimentary subscription included)**	●	●	●	●
Auxiliary electrical outlets in rear (x2)	●	●	●	●
Rear Seat Entertainment with dual 10" LCD screens that folds into the rear of the front seats. Includes Rear Multimedia Interface, Touchscreen remote control and 2 wireless headphones (Long Wheelbase models only)	—	P3	P3	—
NAVIGATION				
Touch Pro™ Navigation*	●	●	●	●
Bluetooth® v2.0 wireless technology for cell phone and audio streaming†	●	●	●	●
TELEMATICS				
Protect™ - SOS emergency call, Jaguar Assistance Call and stolen vehicle locator. Service complimentary for 5 years	●	●	●	●
Remote™ - Smartphone application for vehicle status (fuel level, security status, last parked, direction to vehicle), vehicle lock/unlock, A/C remote setting through engine start. Feature complimentary for 5 years	●	●	●	●
Wi-Fi - 4G hotspot - includes 4GB or 3 months (whichever comes first) complimentary data subscription††	●	●	●	●

*Do not use Jaguar InControl® features under conditions that will affect your safety or the safety of others. Driving while distracted can result in loss of vehicle control. **A 3-month trial subscription to the SiriusXM Select+ package is included with equipped vehicles, which gives you access to 130 channels of premium programming. Plus you can stream SiriusXM on your computer, smartphone or tablet - it's included in your trial. If you decide to continue service after your trial, the subscription plan you choose will automatically renew thereafter and you will be charged according to your chosen payment method at then-current rates. Fees and taxes apply. To cancel you must call SiriusXM at 1-888-539-7474. See the SiriusXM Customer Agreement for complete terms at siriusxm.ca/terms-and-conditions. All fees and programming are subject to change. †Driving while distracted can result in loss of vehicle control. Do not operate, adjust or view the navigation or multimedia systems under conditions that will affect your safety or the safety of others. Only use mobile phones, and other devices, even with voice commands, when it is safe to do so ††The Wi-Fi Hotspot is intended for passenger use only. Jaguar InControl® features may require an additional subscription with separate terms and conditions.

OPTIONS PACKAGES

		XJ R-SPORT	XJ & XJL PORTFOLIO	XJ50 LWB	XJR575 LWB	
	CODE					DESCRIPTION
Comfort Package (P1)	017CI	○	—	—	—	18-way adjustable front seats, front seat massage with 5 modes, each with 5 intensity settings, passenger memory seats, four-zone air conditioning, electric rear sunblind
Illumination Package (P2)	075GB	○	○	—	—	Illuminated stainless steel sill treadplates - Jaguar script, illuminated air vents front and rear, illuminated trunk latch finishing plate, LED rear reading lights (SWB models)
Premium Rear Seat Package (P3)	017MM	—	○ ¹	○	—	Two individual rear seats with back movement and upper articulation including massage with 3 intensity setting, folding rear centre armrest with rear seat switch panels, standard electric side window sunblinds (standard on all models), winged headrests (removes embossed leaper), rear seat memory, rear business tables, remote control of all seats positions from Touchscreen, Rear Seat Entertainment - Dual 10" LCD screens, Touchscreen remote control and wireless digital headphones (x2)

STAND ALONE OPTIONS

Adaptive Cruise Control with Forward Alert, Emergency Brake Assist and Queue Assist†	065AG	○	○	○	○	—
Meridian™ 1,300W Reference Sound System with Conversation Assist	025LV	○	○	○	—	Refer to page 46
Wood and leather heated steering wheel	032DR	○	○	—	—	—
Heated front windshield with timer	040AK	○	○	○	○	—
Front ashtray and lighter	094AA	NCO	NCO	NCO	NCO	—
Nameplate debadging	057LA	NCO	NCO	—	—	Removes "XJ/XJL" and displacement badge
Ebony suedecloth headliner	032BU	—	NCO	NCO	●	—
360° Surround Camera [‡]	086GJ	○	○	●	○	—

● Standard ○ Optional — Not available NCO No Cost Option

†These features are not a substitute for driving safely with due care and attention and will not function under all circumstances, speeds, weather and road conditions, etc. Driver should not assume that these features will correct errors of judgment in driving. Please consult the owner's manual or your local Jaguar Retailer for more details.

[‡]Not available on XJ Portfolio.

P1 Comfort Package P2 Illumination Package P3 Premium Rear Seat Package

3 CHOOSE YOUR COLOUR

 [Configure your vehicle at jaguar.ca](https://www.jaguar.ca)

SOLID

Fuji White

Narvik Black

METALLIC

Yulong White

Indus Silver

Corris Grey

Loire Blue

Rosello Red

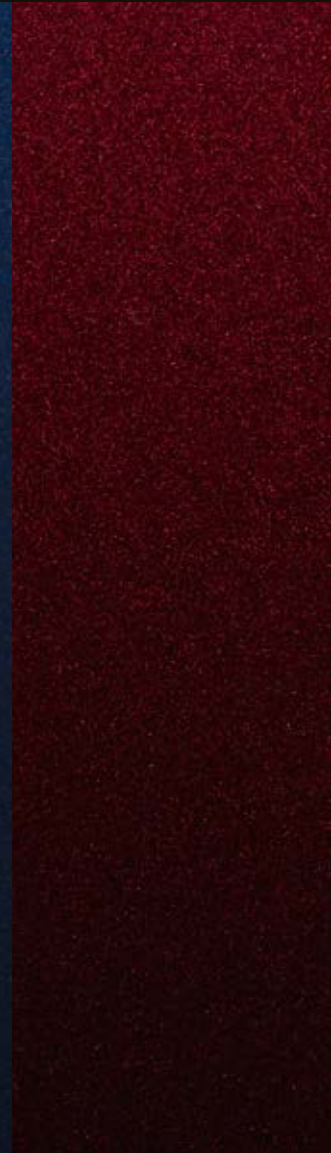
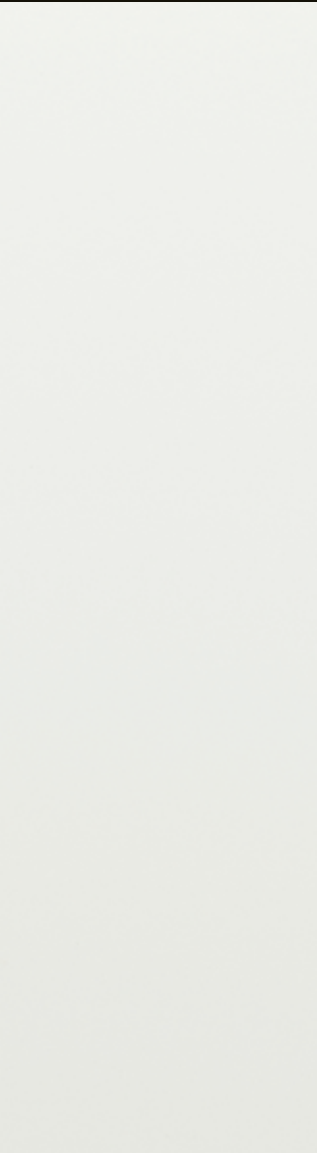

Firenze Red



British Racing Green



Santorini Black



PREMIUM METALLIC

Carpathian Grey



Farallon Black



SVO PREMIUM PALETTE

Velocity Blue



Satin Corris Grey



4 CHOOSE YOUR WHEELS

 Configure your vehicle at jaguar.ca



19" 10 SPOKE
'STYLE 1028'

ALLOY WHEEL FINISH	Sparkle Silver
ALLOY WHEEL / SIZE	9.0J x 19" / 10.0J x 19"
TIRE SIZE	245/45ZR19 / 275/40ZR19
CODE	031GN
XJ R-Sport	●
XJ & XJL Portfolio	—
XJ50 LWB	—
XJR575 LWB	—



19" 5 SPLIT-SPOKE
'STYLE 5043'

ALLOY WHEEL FINISH	Sparkle Silver
ALLOY WHEEL / SIZE	9.0J x 19" / 10.0J x 19"
TIRE SIZE	245/45ZR19 / 275/40ZR19
CODE	031HC
XJ R-Sport	○
XJ & XJL Portfolio	●
XJ50 LWB	—
XJR575 LWB	—



19" 7 SPLIT-SPOKE
'STYLE 7016'

ALLOY WHEEL FINISH	Sparkle Silver
ALLOY WHEEL / SIZE	9.0J x 19" / 10.0J x 19"
TIRE SIZE	245/45ZR19 / 275/40ZR19
CODE	031GT
XJ R-Sport	○
XJ & XJL Portfolio	○
XJ50 LWB	○
XJR575 LWB	—



20" 8 SPLIT-SPOKE
'STYLE 8001'

ALLOY WHEEL FINISH	Silver
ALLOY WHEEL / SIZE	9.0J x 20" / 10.0J x 20"
TIRE SIZE	245/40ZR20 / 275/35ZR20
CODE	031GI
XJ R-Sport	○
XJ & XJL Portfolio	○
XJ50 LWB	—
XJR575 LWB	—

● Standard ○ Option — Not Applicable

¹Not available on SWB XJ50. ²Only available on SWB Portfolio.

Standard and optional features may differ depending on market availability. Please consult your local Jaguar Retailer for details.



20" 8 SPLIT-SPOKE
'STYLE 8001'



20" 10 SPLIT-SPOKE
'STYLE 1029'¹²



20" 5 SPLIT-SPOKE
'STYLE 5045'

ALLOY WHEEL FINISH	Polished	High Gloss Silver	Gloss Black Diamond Turned
ALLOY WHEEL / SIZE	9.0J x 20" / 10.0J x 20"	9.0J x 20" / 10.0J x 20"	9.0J x 20" / 10.0J x 20"
TIRE SIZE	245/40ZR20 / 275/35ZR20	245/40ZR20 / 275/35ZR20	245/40ZR20 / 275/35ZR20
CODE	031GL	031GO	031QZ
XJ R-Sport	○	—	—
XJ & XJL Portfolio	○	○ ²	—
XJ50 LWB	—	—	●
XJR575 LWB	—	—	—



20" 5 SPLIT-SPOKE
'STYLE 5045'



20" 5 SPLIT-SPOKE
'STYLE 5044'



20" 5 SPLIT-SPOKE
'STYLE 5044'

ALLOY WHEEL FINISH	Diamond Turned	Technical Grey	Gloss Black
ALLOY WHEEL / SIZE	9.0J x 20" / 10.0J x 20"	9.0J x 20" / 10.0J x 20"	9.0J x 20" / 10.0J x 20"
TIRE SIZE	245/40ZR20 / 275/35ZR20	265/35R20 / 295/30R20	265/35R20 / 295/30R20
CODE	031GS	031GW	031GV
XJ R-Sport	○	—	—
XJ & XJL Portfolio	—	—	—
XJ50 LWB	—	—	—
XJR575 LWB	—	○	●

5 CHOOSE YOUR INTERIOR

 Configure your vehicle at jaguar.ca

XJ R-SPORT							
SEAT SOFT GRAIN PERFORATED LEATHER WITH STITCH/PIPING	VENEER*	MORZINE HEADLINING	UPPER FACIA SOFT FEEL	LOWER FACIA	CARPET	INTERIOR TRIM CODES	
Ivory/Mineral/Mineral	Gloss Burr Walnut	Ivory	Mineral	Ivory	Mineral	SCT	
Cashew/Truffle/Truffle	Gloss Burr Walnut	Ivory	Truffle	Cashew	Truffle	SAZ	
London Tan/Ebony/Ebony	Gloss Burr Walnut	Ivory	Ebony	Ebony	Ebony	SAD	
Ebony/Ivory/Ivory	Gloss Burr Walnut	Ivory	Ebony	Ebony	Ebony	TXQ	

XJ & XJL PORTFOLIO							
SEAT SOFT GRAIN QUILTED AND PERFORATED LEATHER WITH STITCH	VENEER*	PREMIUM SUEDECLOTH HEADLINING	UPPER FACIA SOFT GRAIN LEATHER	LOWER FACIA	CARPET	INTERIOR TRIM CODES	
Ebony/Ivory	Gloss Burr Walnut	Ivory or Ebony	Ebony	Ebony	Ebony	TXS	
London Tan/Ebony	Gloss Burr Walnut	Ivory or Ebony	Ebony	London Tan	Ebony	SAF	
Cashew/Truffle	Gloss Burr Walnut	Ivory	Truffle	Cashew	Truffle	SBB	
Ivory/Mineral	Gloss Burr Walnut	Ivory	Mineral	Ivory	Mineral	SCU	
Ivory/Ebony	Gloss Burr Walnut	Ivory or Ebony	Ebony	Ivory	Ebony	TXH	

*Optional veneers are available.
Please consult your local Jaguar Retailer for details.

XJ50 LWB							
SEAT SOFT GRAIN PERFORATED LEATHER WITH STITCH	VENEER*	PREMIUM SUEDECLOTH HEADLINING	UPPER FACIA SOFT GRAIN LEATHER	LOWER FACIA	CARPET	INTERIOR TRIM CODES	
Ivory/Ebony	Gloss Shadow Walnut	Ivory or Ebony	Ebony	Ivory	Ebony	SHM	
Ebony/Ivory	Gloss Shadow Walnut	Ivory or Ebony	Ebony	Ebony	Ebony	SHL	

XJR575 LWB							
SEAT SOFT GRAIN PERFORATED LEATHER WITH STITCH	VENEER*	PREMIUM SUEDECLOTH HEADLINING	UPPER FACIA SOFT GRAIN LEATHER	LOWER FACIA	CARPET	INTERIOR TRIM CODES	
Ebony/Pimento	Carbon Fibre	Ebony	Ebony	Ebony	Ebony	TXT	
Ivory/Ebony	Carbon Fibre	Ebony	Ebony	Ivory	Ebony	TXE	

5 CHOOSE YOUR INTERIOR





















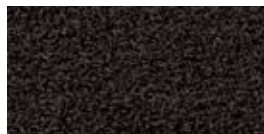

⚙️ Configure your vehicle at jaguar.ca

Interior shown: Cashew soft grain perforated leather seats with Truffle upper facia, Ivory Morzine headlining, Gloss Figured Ebony veneer and Truffle carpet.



XJ R-SPORT

INTERIOR COLOUR COMBINATIONS

1	2	3	4	5	6
SEAT WITH CONTRAST STITCH AND PIPING	VENEER	MORZINE HEADLINING	UPPER FACIA	LOWER FACIA	CARPET
 Ivory with Mineral stitch	 Gloss Burr Walnut	 Ivory	 Mineral	 Ivory	 Mineral
 Cashew with Truffle stitch	 Gloss Burr Walnut	 Ivory	 Truffle	 Cashew	 Truffle
 London Tan with Ebony stitch	 Gloss Burr Walnut	 Ivory	 Ebony	 Ebony	 Ebony
 Ebony with Ivory stitch	 Gloss Burr Walnut	 Ivory	 Ebony	 Ebony	 Ebony

VENEER OPTIONS

Carbon Fibre, Piano Black or Gloss Figured Ebony

5 CHOOSE YOUR INTERIOR

⚙️ Configure your vehicle at jaguar.ca











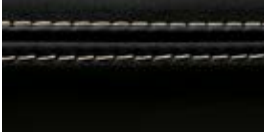



















Interior shown: Ivory quilted soft grain perforated leather seats with Ebony contrast stitch, Ebony upper fascia, Ivory Suedecloth headlining, Gloss Burr Walnut veneer and Ebony carpet.

Image shown includes Rear Seat Entertainment.

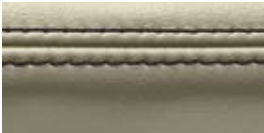

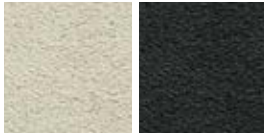
XJ & XJL PORTFOLIO

INTERIOR COLOUR COMBINATIONS

1	2	3	4	5	6
SEAT WITH CONTRAST STITCH	VENEER	SUEDECLOTH HEADLINING	UPPER FACIA	LOWER FACIA	CARPET
 Ebony with Ivory stitch	 Gloss Burr Walnut	 Ivory or Ebony	 Ebony	 Ebony	 Ebony
 London Tan with Ebony stitch	 Gloss Burr Walnut	 Ivory or Ebony	 Ebony	 London Tan	 Ebony
 Cashew with Truffle stitch	 Gloss Burr Walnut	 Ivory	 Truffle	 Cashew	 Truffle
 Ivory with Mineral stitch	 Gloss Burr Walnut	 Ivory	 Mineral	 Ivory	 Mineral
 Ivory with Ebony stitch	 Gloss Burr Walnut	 Ivory or Ebony	 Ebony	 Ivory	 Ebony

VENEER OPTIONS

Carbon Fibre, Piano Black or Gloss Figured Ebony

5 CHOOSE YOUR INTERIOR

Configure your vehicle at jaguar.ca













Interior shown: Ivory soft grain perforated quilted leather seats with Ebony contrast stitch, Ebony upper fascia, Ivory suedecloth headlining, Gloss Shadow Walnut veneer and Ebony carpet.

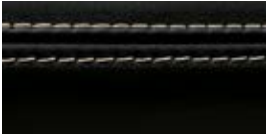

XJ50 LWB

INTERIOR COLOUR COMBINATIONS

STANDARD - SOFT GRAIN LEATHER SEAT

1	2	3	4	5	6
<p>LEATHER SEAT WITH CONTRAST STITCH</p>  <p>Ivory with Ebony stitch</p>	<p>VENEER</p>  <p>Gloss Shadow Walnut</p>	<p>SUEDECLOTH HEADLINING</p>  <p>Ivory or Ebony</p>	<p>UPPER FACIA</p>  <p>Ebony</p>	<p>LOWER FACIA</p>  <p>Ivory</p>	<p>CARPET</p>  <p>Ebony</p>
 <p>Ebony with Ivory stitch</p>	 <p>Gloss Shadow Walnut</p>	 <p>Ivory or Ebony</p>	 <p>Ebony</p>	 <p>Ebony</p>	 <p>Ebony</p>

5 CHOOSE YOUR INTERIOR

⚙️ Configure your vehicle at jaguar.ca

Interior shown: Ebony soft grain perforated quilted leather sports seats with Pimento contrast stitch, Ebony upper fascia, Ebony suedecloth headlining, Carbon Fibre veneer and Ebony carpet.



XJR575 LWB

INTERIOR COLOUR COMBINATIONS

1

LEATHER SEAT WITH
CONTRAST STITCH

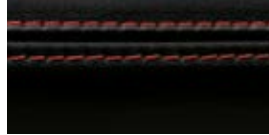

Ebony with Pimento stitch

2

VENEER



Carbon Fibre

3

SUEDECLOTH HEADLINING



Ebony

4

UPPER FACIA



Ebony

5

LOWER FACIA



Ebony

6

CARPET



Ebony



Ivory with Ebony stitch



Carbon Fibre



Ebony



Ebony



Ivory



Ebony

VENEER OPTION

Piano Black

5 CHOOSE YOUR INTERIOR

 Configure your vehicle at jaguar.ca

Piano Black

Carbon Fibre

Gloss Figured Ebony

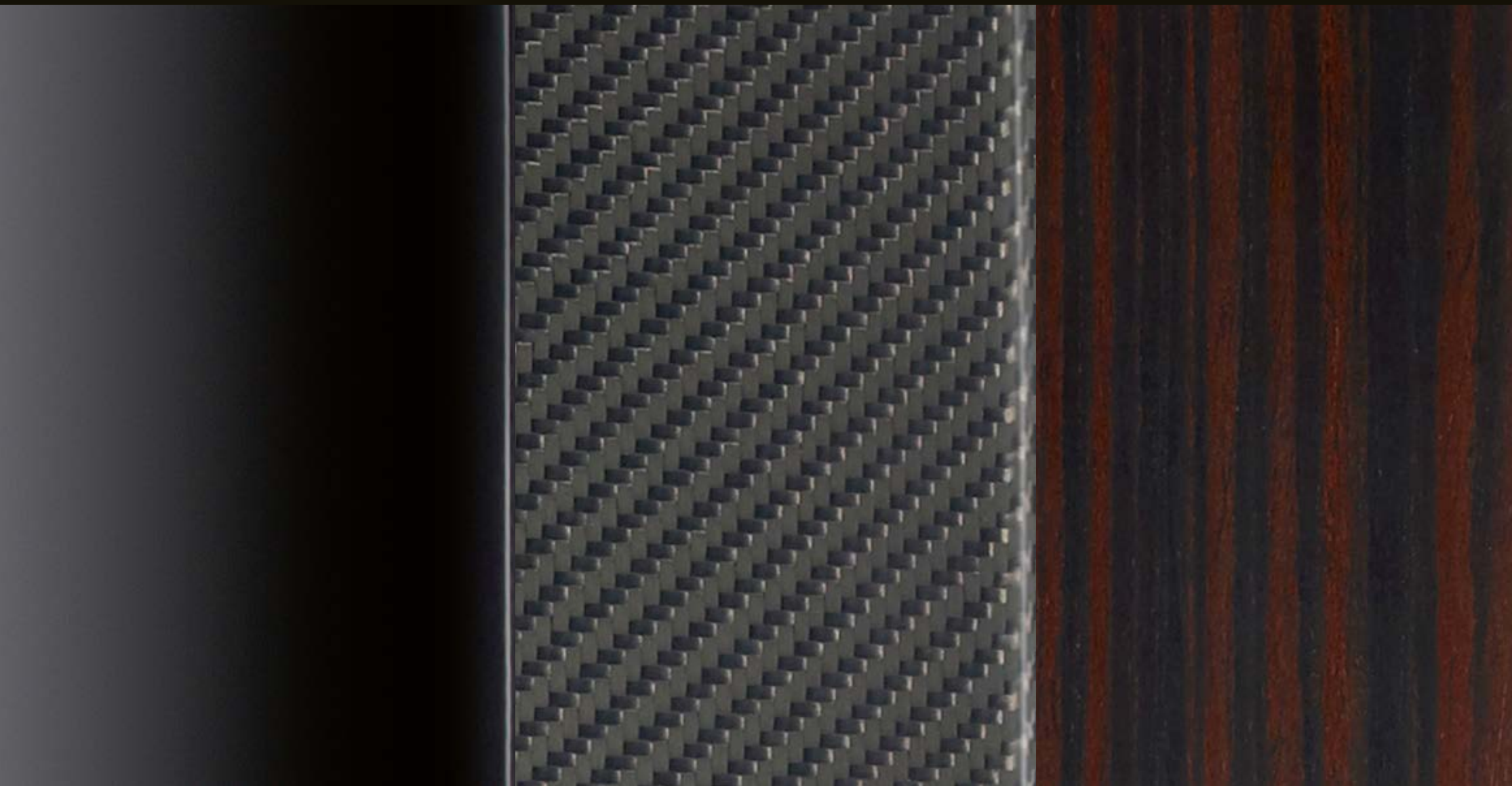

Gloss Burr Walnut



Gloss Shadow Walnut



6 CHOOSE YOUR JAGUAR GEAR - ACCESSORIES

To find out more about the full range of Retailer fit Jaguar Gear - Accessories, please refer to your Retailer or go to jaguar.ca



Chrome Mirror Cover
C2D5489 - Left
C2D5488 - Right

Chrome mirror covers accentuate the stylish design of the exterior mirrors. Left and right side options available.

*Not compatible with rear seat entertainment.



Splash Guards
C2D8498 - Front
C2D8499 - Rear

Jaguar branded front splash guards complement the lines of your vehicle, reduce spray and help to provide protection from dirt and stone chippings.



Click and Hang*
J9C2167

The Click and Hang is part of the Click and Go range. This removable coat hanger allows shirts or jackets to be kept crease-free while transporting. Also includes an integral hook for use outside the vehicle.



Aluminum Gearshift Paddles
T2R6547MMU

Replacement steering wheel gearshift paddles, offered in a Premium aluminum material, provide a high quality finish to a key contact point in the vehicle. Manufactured from billet machined aluminum, the paddles are hand brushed for a Premium finish and anodized to ensure they will not deteriorate with wear.



Illuminated Treadplate

Elegantly styled aluminum sill treadplates illuminate when the driver or passenger doors are opened. Highlighted by soft Phosphor Blue lighting. Please consult your authorized Jaguar Retailer for ordering information.



Click and Play*
J9C2164

The Click and Play iPad 2 - 4 holder is part of the Click and Go range. This removable tablet holder attachment can easily be positioned at multiple angles for in-cabin comfort and rear entertainment.



Premium Cargo Space Mat
C2D7450

Luxurious soft luggage mat in Ebony Black with the Jaguar logo. Deep premium 2,050g/m² pile with Nubuck edging and Dove contrast stitch.

TECHNICAL SPECIFICATIONS

 Configure your vehicle at jaguar.ca

ENGINES		JAGUAR 3.0 LITRE V6 340 SUPERCHARGED GAS
Drive		AWD
Capacity	cc	2,995
Maximum power	HP	340
@rev/min		6,500
Maximum torque	lb-ft	332
@rev/min		3,500-5,000
Transmission		8-speed automatic
Tank capacity - SWB	litres	80
Tank capacity - LWB	litres	80
PERFORMANCE		
0/100km/h	seconds	6.4
Top speed	km/h	195
ENGINE AVAILABILITY		
XJ R-Sport		●
XJ & XJL Portfolio		●
XJ50 LWB		●
XJR575 LWB		—

● Standard — Not available

**JAGUAR
5.0 LITRE V8
575 SUPERCHARGED
GAS**

ENGINES

Drive		RWD
Capacity	cc	5,000
Maximum power	HP	575
@rev/min		6,250-6,500
Maximum torque	lb-ft	517
@rev/min		3,500-4,500
Transmission		8-speed automatic
Tank capacity - SWB	litres	80
Tank capacity - LWB	litres	80

PERFORMANCE

0/100km/h	seconds	4.4
Top speed	km/h	280

ENGINE AVAILABILITY

XJ R-Sport	—
XJ & XJL Portfolio	—
XJ50 LWB	—
XJR575 LWB	●

TECHNICAL SPECIFICATIONS

⚙️ Configure your vehicle at jaguar.ca



VEHICLE SHOWN: 2019 JAGUAR XJ PORTFOLIO LONG WHEELBASE WITH OPTIONAL EQUIPMENT

STANDARD WHEELBASE		JAGUAR 3.0 LITRE V6 340 SUPERCHARGED GAS	JAGUAR 5.0 LITRE V8 575 SUPERCHARGED GAS
Drive		AWD	-
Overall length	mm	5,130	-
Overall width (inc./with folded mirrors)	mm	2,105/1,950	-
Overall height (inc. antenna)	mm	1,460	-
Wheelbase	mm	3,032	-
Front/Rear track	mm	1,626/1,604	-
Turning circle (wall-to-wall)	m	12.6	-
Trunk volume with space saver spare wheel	litres	520	-
Front/Rear legroom	mm	1,055/988	-
Headroom with sunroof (front)	mm	1,004	-
Headroom (rear)	mm	945	-
Front/Rear shoulder room	mm	1,464/1,437	-
Weight*	kg	1,865	-
Gross vehicle weight*	kg	2,400	-
LONG WHEELBASE			
Drive		AWD	RWD
Overall length	mm	5,255	5,255
Overall width (inc./with folded mirrors)	mm	2,105/1,950	2,105/1,950
Overall height (inc. antenna)	mm	1,460	1,460
Wheelbase	mm	3,157	3,157
Front/Rear track	mm	1,626/1,604	1,626/1,604
Turning circle (wall-to-wall)	m	13.1	12.5
Trunk volume with space saver spare wheel	litres	520	478
Front/Rear legroom	mm	1,055/1,109	1,055/1,109
Headroom with sunroof (front)	mm	1,004	1,004
Headroom (rear)	mm	946	946
Front/Rear shoulder room	mm	1,464/1,437	1,464/1,437
Weight*	kg	1,875	1,885
Gross vehicle weight*	kg	2,450	2,450

*Weights reflect vehicles to standard specifications. Optional extras increase weight.
Dimensions were measured with vehicle at unladen weight.
Trunk volume measured by VDA standard test method using 200 x 100 x 50mm blocks.

SPECIAL VEHICLE OPERATIONS



Special Vehicle Operations (SVO) designs and engineers products that amplify Jaguar and Land Rover core brand values; focusing on luxury, performance and capability.

Our team of specialists is completely focused on enhancing and personalizing our relationship with our most discerning and enthusiastic customers – delivering experiences that our customers will love for life.

SVO is responsible for the creation of a suite of halo products that showcase the pinnacle of Jaguar design and engineering capabilities, enabling our customers to indulge their passion for spectacular new vehicles.

THE NEW SVO TECHNICAL CENTRE

In the heart of the British Midlands is SVO's brand new Technical Centre. This state-of-the-art facility represents a \$25 million dollar investment by Jaguar Land Rover, and features four zones designed to support the creation of truly breath-taking vehicles. In addition to the Commissioning and Presentation suites, our manufacturing centre is responsible for the assembly and hand-finishing of SVO halo and Collector's Edition vehicles, and a world-class paint facility ensures an exquisite finish for every vehicle we create.

BESPOKE BY SVO

Bespoke by SVO was born out of an innate understanding of what our most discerning clients value more than anything else – to own something completely unique to them. Something only they can have, reflecting who they are and what they hold most dear. With that in mind, SVO developed innovative Commissioning and Presentation suites enabling creation of the most refined and luxurious vehicles in the world. This special new facility is housed within the new SVO Technical Centre in Warwickshire, England.





THE WORLD OF JAGUAR

Choose the XJ and you're joining the exciting World of Jaguar.

JAGUAR EXPERIENCE

There's no better way to get to know Jaguar than by taking a drive. The Jaguar Experience offers a range of unique opportunities to really find out what it feels like to get the most out of a Jaguar. Our track experiences allow you to push yourself and cars from the incredible Jaguar range to the limit.

Find out more by visiting jaguar.ca

BEHIND THE SCENES

Our factory tours give you the unique opportunity to experience the whole process of how our vehicles are brought to life - from the moulding of sheet metal to those intricate final touches. At our state-of-the-art production facilities, you'll get to see how skilled technicians and sophisticated machines work seamlessly together to perfect some of Jaguar's most breathtaking vehicles.

Find out more at jaguar.ca

ICE DRIVE EXPERIENCES

Take your driving to the next level with the Jaguar Land Rover Ice Drive Experience. We offer an adventure in Arjeplog, Sweden, that will test and develop your performance driving skills in extreme conditions. It's a rare chance for owners and enthusiasts to tackle some of the harshest and most challenging tracks on earth, under the skilled guidance of our experts. Our driving instructors are of the highest-calibre and will be with you every step of the way - ready to impart years of driving wisdom. You will dance on ice, glide around some of the most awe-inspiring corners imaginable and realize the true exhilarating potential of Jaguar and Land Rover.

If you'd like to be part of the next adventure, find out more by visiting jaguar.ca

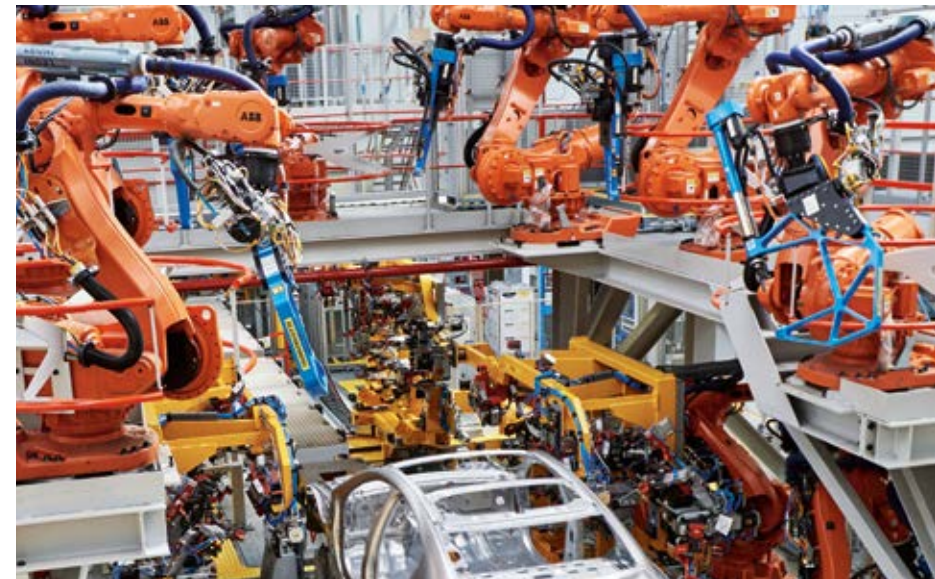



FORMULA E

Jaguar's reputation for performance, technology and design was forged by the world's most challenging circuits and championships. From Le Mans to Formula 1, and now Formula E, the grid is our test-bed. Formula E provides the perfect proving ground for electric vehicle technology in a high performance environment. The racing series accelerates the development of Jaguar's electric powertrains. With every race, Formula E helps Jaguar engineers create better electric vehicles.

Find out more by visiting jaguar.ca/en/jaguar-racing

JAGUAR COLLECTION

The latest range from the Jaguar Collection has been crafted with the same design execution and attention to detail that goes into all of our vehicles. This is evident in our clothing range, premium leather items and luxury travel goods. To celebrate Jaguar's heritage, we also have a collection that honours past achievements and features race inspired gift items and apparel.

Visit your Retailer to browse the Jaguar Collection.

THE JAGUAR MAGAZINE

This is our own vibrant, cosmopolitan and contemporary magazine. Produced by a team of enthusiastic designers and feature writers, it goes behind the scenes at Jaguar as well as providing insight into the world of luxury, design, style and travel.

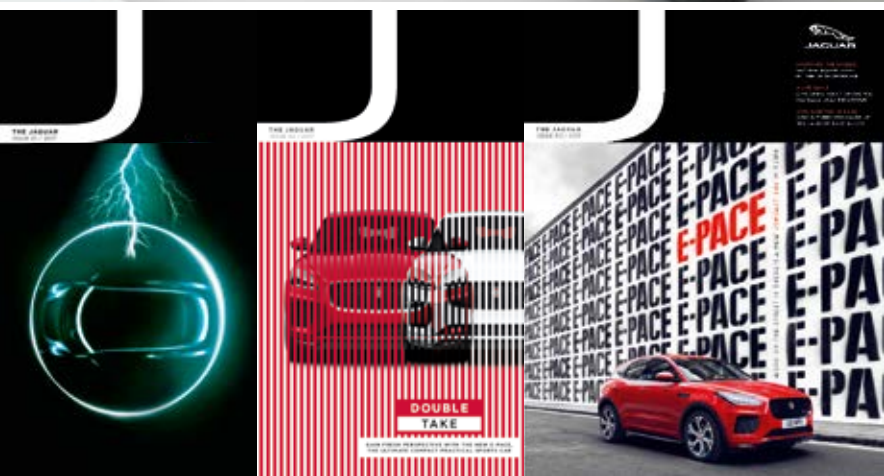



AT YOUR SERVICE

As well as providing a range of exclusive services and lifestyle products, the World of Jaguar makes owning and driving carefree and easy.

NEW LIMITED VEHICLE WARRANTY

The New Vehicle Limited Warranty (The "Warranty") lets you enjoy your driving with peace of mind. The Warranty is fully transferable to subsequent owners and remains in effect throughout the Warranty coverage period.

GENUINE PARTS

Jaguar Genuine Parts are designed, tested and manufactured to our uncompromising standards for quality, fit and durability. Each part is engineered specifically for your XJ to contribute to optimum performance and to help maximize its lifespan.

SERVICING

Relax in the knowledge that long-term performance is assured with the Complimentary First Scheduled Maintenance Coverage. It covers the first factory recommended scheduled servicing as detailed in the "Passport to Service". A Service Interval Indicator will appear to remind you to take advantage of your first scheduled complimentary maintenance.

JAGUAR ASSISTANCE

Jaguar Optimized Assistance provides assistance in motoring emergencies, from immobilization due to breakdown or accident to minor problems such as punctures. You can rely on our roadside assistance, whatever the situation, anywhere in North America during the vehicle's warranty period.

JAGUAR CANADA FINANCIAL SERVICES

New or used, for personal or business use, we have a finance option that puts you in complete control. Please speak to your local authorized Jaguar Retailer to find out more.

IMPORTANT NOTICE

Jaguar Land Rover Canada ULC is constantly seeking ways to improve the specification, design and production of its vehicles and alterations take place continually. While every effort is made to produce up-to-date literature, this brochure should not be regarded as an infallible guide to current specifications, nor does it constitute an offer for the sale of any particular vehicle. Distributors and Retailers are not agents of Jaguar Land Rover Canada ULC by any express or implied undertaking or representation. Comparisons are based on manufacturer's own data and testing prior to publication.

COLOURS

The colours reproduced here are subject to the limitations of the printing process and may therefore vary slightly from the actual vehicle. The company reserves the right to alter or withdraw any colour finish without notice. Some of these colours may not be obtainable in your country. Please check availability of colours and current specifications with your Jaguar Retailer. Distributors and retailers are not agents of Jaguar Land Rover Canada ULC and have absolutely no authority to bind Jaguar Land Rover Canada ULC to any express or implied undertaking or representation.

ENVIRONMENTAL INNOVATION AT JAGUAR

Jaguar is committed to reducing dependency on fossil fuels, using fewer natural resources and creating less waste as part of our approach to responsible and sustainable business development.

Search 'Jaguar Environmental Innovation' for more details.

Meridian is the trademark of Meridian Audio Ltd.

AdBlue® is the registered trademark of the Verband der Automobilindustrie e. V. (VDA)

The Bluetooth® word mark and logos are owned by the Bluetooth SIG, Inc. and any use of such marks by Jaguar Land Rover Limited is under license.

iPod, iPod touch and iPad are trademarks of Apple Inc, registered in the US and other countries.

The navigation system must always be used in conditions that will not affect the driver's ability to drive safely or affect the safety of other road users.

Celeron, Centrino, Intel, the Intel logo, Intel Atom, Intel Core, Intel Inside, the Intel Inside logo, Intel vPro, Intel Xeon Phi, Itanium, Pentium, and Xeon are trademarks of Intel Corporation in the U.S and/or other countries.

Trifield and the "three fields" device is a trademark of Trifield Productions Ltd.

VEHICLE SHOWN: 2019 JAGUAR XJ PORTFOLIO LONG WHEELBASE IN CARPATHIAN GREY WITH OPTIONAL EQUIPMENT

VEHICLE SHOWN FRONT AND BACK COVER: 2019 JAGUAR XJ50 LONG WHEELBASE IN LOIRE BLUE WITH OPTIONAL EQUIPMENT

Jaguar Land Rover Canada ULC
75 Courtneypark Drive W, Unit 3.
Mississauga, Ontario, L5W OE3

jaguar.ca

© 2018 Jaguar Land Rover Canada ULC

1X3511910000BCAEN01P

