

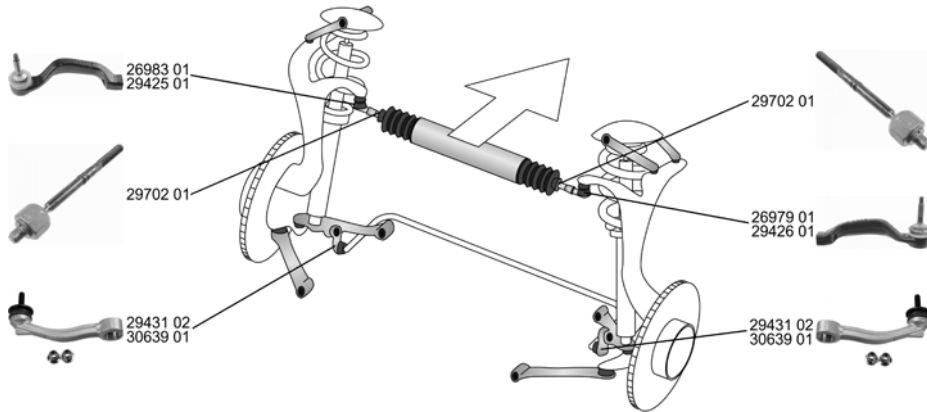

























JAGUAR

S-TYPE (CCX)

01.99 -



































	Spurstangenkopf / Tie Rod End	(28)		26979 01	XR8 1770	
	ALL TYPES		->Chass. M45254			
	Spurstangenkopf / Tie Rod End	(28)		26983 01	XR8 1771	
	ALL TYPES		->Chass. M45254			
	Spurstangenkopf / Tie Rod End	(28)		29425 01	C2C 35783	
	radseitig / Wheel Side Innengewinde [mm] / Inner Thread [mm]: M14x1,5 Gewindemaß / Thread Size: M12x1,75	(233) (75) (63)				
	ALL TYPES		Chass. M45255->			
	Spurstangenkopf / Tie Rod End	(28)		29426 01	C2C 20176	
	radseitig / Wheel Side Innengewinde [mm] / Inner Thread [mm]: M14x1,5 Gewindemaß / Thread Size: M12x1,75	(233) (75) (63)				
	ALL TYPES		Chass. M45255->			
	Axialgelenk, Spurstange / Tie Rod Axle Joint	(5)		29702 01	C2C 29620 C2C 38669	
	radseitig / Wheel Side Gewindemaß / Thread Size: M16x1,5 Gewindemaß / Thread Size: M14x1,5	(233) (63) (63)				
	3.0 V6	01.99 -		04.2002->		
	2.5 V6	04.02 -				
	4.2 V8	04.02 -				
	R 4.2 V8 2.7 D	04.02 - 06.04 -				
	Faltenbalg, Lenkung / Bellow, steering	(7)		34340 01	XR8 14991	
	Innendurchmesser 1 [mm] / Inner Diameter 1 [mm]: 13 Innendurchmesser 2 [mm] / Inner Diameter 2 [mm]: 56	(72) (73)				
	ALL TYPES		->Chass. L86901			
	Faltenbalg, Lenkung / Bellow, steering	(7)		34341 01	XR8 30015	
	Innendurchmesser 1 [mm] / Inner Diameter 1 [mm]: 13 Innendurchmesser 2 [mm] / Inner Diameter 2 [mm]: 63	(72) (73)				
	ALL TYPES		Chass. L86902->			
	Faltenbalg, Lenkung / Bellow, steering	(7)		35015 01	XR8 7398	
	Durchmesser 1 [mm] / Diameter 1 [mm]: 13 Durchmesser 2 [mm] / Diameter 2 [mm]: 75	(50) (52)				
	ALL TYPES		->Chass. L86901			



Ref.

JAGUAR

S-TYPE (CCX) 01.99 -

































	Lenker, Radaufhängung / Track Control Arm Querlenker / Control Arm	(15) (96)		30631 01 XR8 56013	
	ALL TYPES		->Chass. (V) M45254		
	Lenker, Radaufhängung / Track Control Arm Querlenker / Control Arm	(15) (96)		30632 01 XR8 56012	
	ALL TYPES		->Chass. (V) M45254		
	Lenker, Radaufhängung / Track Control Arm Querlenker / Control Arm	(15) (96)		30635 01 XR8 51825	
	ALL TYPES		->Chass. (V) M45254		
	Lenker, Radaufhängung / Track Control Arm Querlenker / Control Arm	(15) (96)		30636 01 XR8 51824	
	ALL TYPES		->Chass. (V) M45254		
	Lenker, Radaufhängung / Track Control Arm Querlenker / Control Arm	(15) (96)		33746 01 XR8 57653	
	ALL TYPES		Chass. M45255->		
	Lenker, Radaufhängung / Track Control Arm Querlenker / Control Arm	(15) (96)		33747 01 XR8 57652	
	ALL TYPES		Chass. M45255->		
	Lagerung, Lenker / Control Arm-Trailing Arm Bush für Querlenker / For control arm	(11) (180)		29783 01 C2C 36029	
	ALL TYPES				
	Lagerung, Lenker / Control Arm-Trailing Arm Bush für Querlenker / For control arm	(11) (180)		29784 01 C2C 4437	
	ALL TYPES		Chass. M45255->		
	Lagerung, Lenker / Control Arm-Trailing Arm Bush für Querlenker / For control arm	(11) (180)		29785 01 C2C 4438	
	ALL TYPES		Chass. (V) M45255->		
	Stange/Strebe, Stabilisator / Link Stabiliser ohne Zubehör / Without accessories Koppelstange / Coupling Rod	(31) (231) (79)		29431 02 C2C 39468	
	ALL TYPES		Chass. M45255->		
	Stange/Strebe, Stabilisator / Link Stabiliser Pendelstange / Suspension Rod	(31) (95)		30639 01 XR8 55185	
	ALL TYPES		->Chass. (V) M45254		



JAGUAR

S-TYPE (CCX)

01.99 -









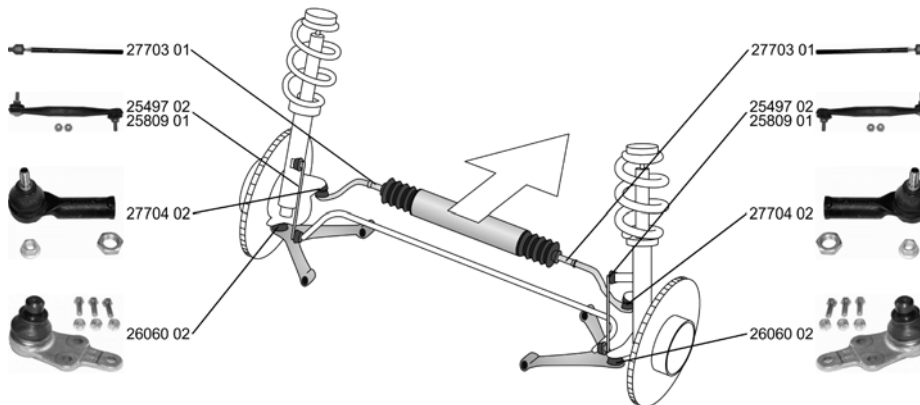











	<p>Lagerung, Radlagergehäuse Bearing, wheel bearing housing Querlenker / Control Arm Bohrung-Ø [mm] / Bore Ø [mm]: 14 ALL TYPES</p>	<p>(12) (96) (44)</p>	<p> </p> <p>Chass. M45255-></p>	<p>33533 01 C2C 36866</p> 
	<p>Spurstange / Rod Assembly ALL TYPES</p>	<p>(27)</p>	<p></p> <p>->Chass. M45254</p>	<p>33589 01 XR8 25750</p> 
	<p>Spurstange / Rod Assembly ALL TYPES</p>	<p>(27)</p>	<p></p> <p>Chass. M45255-></p>	<p>33590 01 C2C 36985</p> 
	<p>Lenker, Radaufhängung / Track Control Arm Querlenker / Control Arm ALL TYPES</p>	<p>(15) (96)</p>	<p> </p>	<p>30633 01 C2P 13877</p> 
	<p>Lenker, Radaufhängung / Track Control Arm Querlenker / Control Arm ALL TYPES</p>	<p>(15) (96)</p>	<p> </p>	<p>30634 01 C2P 13876</p> 
	<p>Lenker, Radaufhängung / Track Control Arm Querlenker / Control Arm ALL TYPES</p>	<p>(15) (96)</p>	<p> </p> <p>->Chass. (V) M45254</p>	<p>30637 01 XR8 8760</p> 
	<p>Lenker, Radaufhängung / Track Control Arm Querlenker / Control Arm ALL TYPES</p>	<p>(15) (96)</p>	<p> </p> <p>->Chass. (V) M45254</p>	<p>30638 01 XR8 8759</p> 
	<p>Stange/Strebe, Stabilisator / Link Stabiliser Pendelstange / Suspension Rod ALL TYPES</p>	<p>(31) (95)</p>	<p></p>	<p>29427 01 C2C 18572</p> 
	<p>Stange/Strebe, Stabilisator / Link Stabiliser Pendelstange / Suspension Rod ALL TYPES</p>	<p>(31) (95)</p>	<p></p>	<p>29428 01 C2C 18571</p> 



JAGUAR

X-TYPE (CF1) 06.01 -







	<p>Spurstangenkopf / Tie Rod End Konusmaß [mm] / Cone Size [mm]: 15 Gewindemaß 1 / Thread Measurement 1: M16x1,5 Gewindemaß 2 / Thread Measurement 2: M10x1,5 mit Zubehör / With accessories</p>	<p>(28)  (77) (64) (65) (209)</p>	<p>27704 02 C2S 47357</p> 
	<p>Axialgelenk, Spurstange / Tie Rod Axle Joint Gewindemaß / Thread Size: M16x1,5</p>	<p>(5)  (63)</p> <p>für Lenkgetriebe-ID / For steering gear ID:ZF (172) 7831 974 179 für Lenkgetriebe-ID / For steering gear ID:ZF (172) 7831 974 180 für Lenkgetriebe-ID / For steering gear ID:ZF (172) 7831 993 105 für Lenkgetriebe-ID / For steering gear ID:ZF (172) 7831 993 106</p>	<p>27703 01 2X43 3200 BE</p> 
	<p>Faltenbalg, Lenkung / Bellow, steering Innendurchmesser 1 [mm] / Inner Diameter 1 [mm]: 16 Innendurchmesser 2 [mm] / Inner Diameter 2 [mm]: 49</p>	<p>(7)  (72) (73)</p>	<p>34938 01 C2S 12019</p> 
	<p>Trag-/Führungsgelenk / Ball Joint mit Zubehör / With accessories</p>	<p>(32)  (209)</p>	<p>26060 02 1X43 3395 AB</p> 
	<p>Stange/Strebe, Stabilisator / Link Stabiliser Pendelstange / Suspension Rod mit Zubehör / With accessories</p>	<p>(31)  (95) (209)</p>	<p>25497 02 C2S 39552</p> 
	<p>Stange/Strebe, Stabilisator / Link Stabiliser Pendelstange / Suspension Rod</p>	<p>(31)  (95)</p>	<p>25809 01 C2S 3248</p> 
	<p>Lagerung, Lenker / Control Arm-Trailing Arm Bush Aussendurchmesser [mm] / Outer Diameter [mm]: 36,5 Innendurchmesser [mm] / Inner Diameter [mm]: 35 für Querlenker / For control arm</p>	<p>(11)  (39) (74) (180)</p>	<p>33780 01 1X43 5B713 AA</p> 











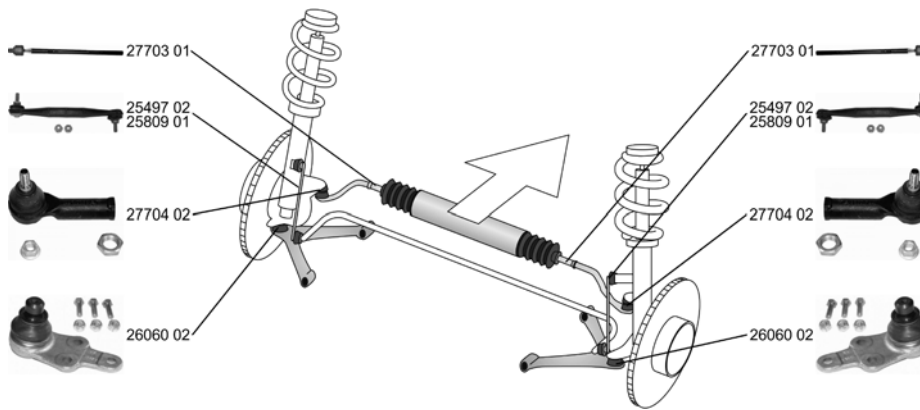

JAGUAR

X-TYPE (CF1) 06.01 -

	Stange/Strebe, Stabilisator / Link Stabiliser Länge innen [mm] / Inner Length [mm]: 58 Koppelstange / Coupling Rod	(31) (85) (79)	↔	29573 01 C2S 45009 
	ALL TYPES			
	Lagerung, Radlagergehäuse Bearing, wheel bearing housing für Querlenker / For control arm	(12) (180)	↕ ↔ ↻	33779 01 1X43 5K743 A 
	ALL TYPES			

X-TYPE Estate 11.03 -











	Spurstangenkopf / Tie Rod End Konusmaß [mm] / Cone Size [mm]: 15 Gewindemaß 1 / Thread Measurement 1: M16x1,5 Gewindemaß 2 / Thread Measurement 2: M10x1,5 mit Zubehör / With accessories	(28) (77) (64) (65) (209)	↕ ↻	27704 02 C2S 47357 
	ALL TYPES			
	Axialgelenk, Spurstange / Tie Rod Axle Joint Gewindemaß / Thread Size: M16x1,5	(5) (63)	↕ ↻	27703 01 2X43 3200 BE 
	ALL TYPES	für Lenkgetriebe-ID / For steering gear ID:ZF 7831 974 179 (172) für Lenkgetriebe-ID / For steering gear ID:ZF 7831 974 180 (172) für Lenkgetriebe-ID / For steering gear ID:ZF 7831 993 105 (172) für Lenkgetriebe-ID / For steering gear ID:ZF 7831 993 106 (172)		
	Faltenbalg, Lenkung / Bellow, steering Innendurchmesser 1 [mm] / Inner Diameter 1 [mm]: 16 Innendurchmesser 2 [mm] / Inner Diameter 2 [mm]: 49	(7) (72) (73)	↔	34938 01 C2S 12019 
	ALL TYPES			
	Trag-/Führungsgelenk / Ball Joint mit Zubehör / With accessories	(32) (209)	↔	26060 02 1X43 3395 AB 
	ALL TYPES			
	Stange/Strebe, Stabilisator / Link Stabiliser Pendelstange / Suspension Rod mit Zubehör / With accessories	(31) (95) (209)	↔	25497 02 C2S 39552 
	2.0 V6 2.5 3.0 2.0 D 2.2 D, 114 kW 2.2 D, 107 kW	11.03 - 02.04 - 02.04 - 02.04 - 10.05 10.05 - 01.07 -		



Ref.





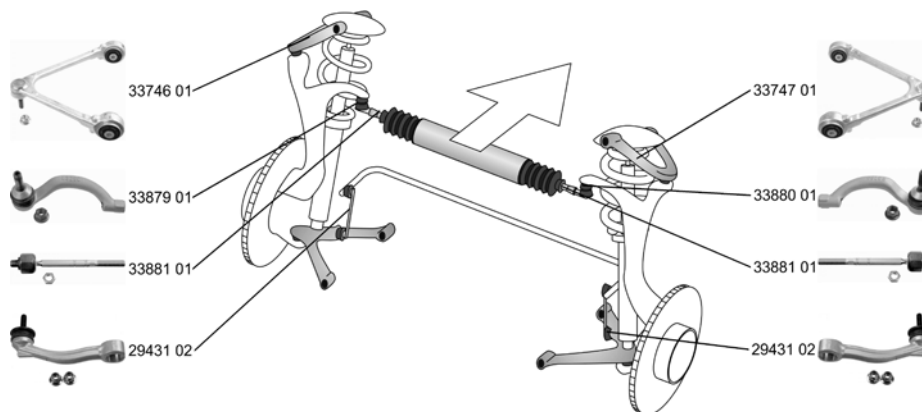

JAGUAR

X-TYPE Estate 11.03 -

	Stange/Strebe, Stabilisator / Link Stabiliser Pendelstange / Suspension Rod	(31) (95)	↔	25809 01 C2S 3248	
	2.2 D, 107 kW	01.07 -	->Chass. D14965		
	Lagerung, Lenker / Control Arm-Trailing Arm Bush Aussendurchmesser [mm] / Outer Diameter [mm]: 36,5 Innendurchmesser [mm] / Inner Diameter [mm]: 35 für Querlenker / For control arm	(11) (39) (74) (180)	↕ ↻ ↺	33780 01 1X43 5B713 AA	
	ALL TYPES				
	Stange/Strebe, Stabilisator / Link Stabiliser Länge innen [mm] / Inner Length [mm]: 58 Koppelstange / Coupling Rod	(31) (85) (79)	↔	29573 01 C2S 45009	
	ALL TYPES				
	Lagerung, Radlagergehäuse Bearing, wheel bearing housing für Querlenker / For control arm	(12) (180)	↕ ↻ ↺	33779 01 1X43 5K743 A	
	ALL TYPES				

XF 03.08 -























	Spurstangenkopf / Tie Rod End Innengewinde [mm] / Inner Thread [mm]: M14x1,5 Aussengewinde [mm] / Outer Thread [mm]: M14x2	(28) (75) (41)	↻ ↺	33879 01 C2Z 5518	
	3.0	03.08 -			
	4.2	03.08 -			
	4.2 Kompressor	03.08 -			
	2.7 D	03.08 -			
	Spurstangenkopf / Tie Rod End Innengewinde [mm] / Inner Thread [mm]: M14x1,5 Aussengewinde [mm] / Outer Thread [mm]: M14x1,5	(28) (75) (41)	↻ ↺	33880 01 C2Z 5517	
	3.0	03.08 -			
	4.2	03.08 -			
	4.2 Kompressor	03.08 -			
	2.7 D	03.08 -			
	Axialgelenk, Spurstange / Tie Rod Axle Joint Gewindemaß 1 / Thread Measurement 1: M16x1,5 Gewindemaß 2 / Thread Measurement 2: M14x1,5	(5) (64) (65)	↔	33881 01 C2Z 2214 C2Z 2215	
	3.0	03.08 -			
	4.2	03.08 -			
	4.2 Kompressor	03.08 -			
	2.7 D	03.08 -			



JAGUAR

XF **03.08 -**









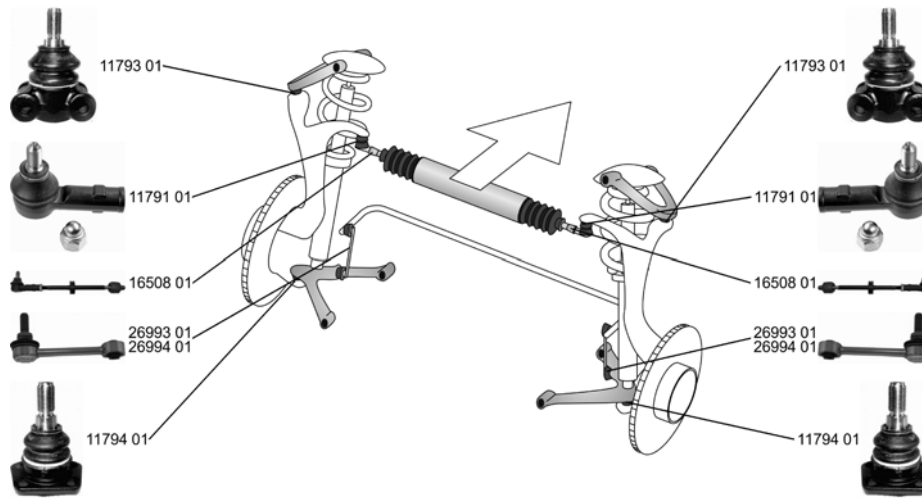



	Faltenbalg, Lenkung / Bellow, steering Innendurchmesser 1 [mm] / Inner Diameter 1 [mm]: 13 Innendurchmesser 2 [mm] / Inner Diameter 2 [mm]: 63 ALL TYPES ausser/except for : 3.0 D, 155 kW 03.09 -	(7) (72) (73)		34341 01 XR8 30015 
	Lenker, Radaufhängung / Track Control Arm Querlenker / Control Arm	(15) (96)		33746 01 XR8 57653 
	3.0 03.08 - 4.2 03.08 - 4.2 Kompressor 03.08 - 2.7 D 03.08 -			
	Lenker, Radaufhängung / Track Control Arm Querlenker / Control Arm	(15) (96)		33747 01 XR8 57652 
	3.0 03.08 - 4.2 03.08 - 4.2 Kompressor 03.08 - 2.7 D 03.08 -			
	Stange/Strebe, Stabilisator / Link Stabiliser ohne Zubehör / Without accessories Koppelstange / Coupling Rod	(31) (231) (79)		29431 02 C2C 39468 
	3.0 03.08 - 4.2 03.08 - 4.2 Kompressor 03.08 - 2.7 D 03.08 -			
	Lagerung, Radlagergehäuse Bearing, wheel bearing housing Querlenker / Control Arm Bohrung-Ø [mm] / Bore Ø [mm]: 14 ALL TYPES ausser/except for : 3.0 D, 155 kW 03.09 -	(12) (96) (44)		35353 01 C2C 36866 
	Stange/Strebe, Stabilisator / Link Stabiliser Pendelstange / Suspension Rod	(31) (95)		29427 01 C2C 18572 
	3.0 03.08 - 4.2 03.08 - 4.2 Kompressor 03.08 - 2.7 D 03.08 -			
	Stange/Strebe, Stabilisator / Link Stabiliser Pendelstange / Suspension Rod	(31) (95)		29428 01 C2C 18571 
	3.0 03.08 - 4.2 03.08 - 4.2 Kompressor 03.08 - 2.7 D 03.08 -			



JAGUAR

XJ (X300) 11.94 - 07.97



	<p>Spurstange / Rod Assembly für / for: ZF ALL TYPES</p>	<p>(27) (116)</p>	<p>↔</p>	<p>16508 01 JLM 409</p> 
	<p>Spurstangenkopf / Tie Rod End mit Rechtsgewinde / with right-hand thread Gewindemaß / Thread Size: M14x1,5 ALL TYPES</p>	<p>(28) (206) (63)</p>	<p>↔ ♂</p>	<p>11791 01 JLM 9660</p> 
	<p>Trag-/Führungsgelenk / Ball Joint ALL TYPES</p>	<p>(32)</p>	<p>↕ ↔</p>	<p>11793 01 CAC 9938</p> 
	<p>Trag-/Führungsgelenk / Ball Joint ALL TYPES</p>	<p>(32)</p>	<p>↕ ↔</p>	<p>11794 01 JLM 11860</p> 
	<p>Stange/Strebe, Stabilisator / Link Stabiliser Koppelstange / Coupling Rod ALL TYPES</p>	<p>(31) (79)</p>	<p>↔ ->Chass. 853935</p>	<p>26993 01 MJA 2105AG</p> 
	<p>Stange/Strebe, Stabilisator / Link Stabiliser Koppelstange / Coupling Rod ALL TYPES</p>	<p>(31) (79)</p>	<p>↔ Chass. 853936-></p>	<p>26994 01 MNC 2105AA</p> 









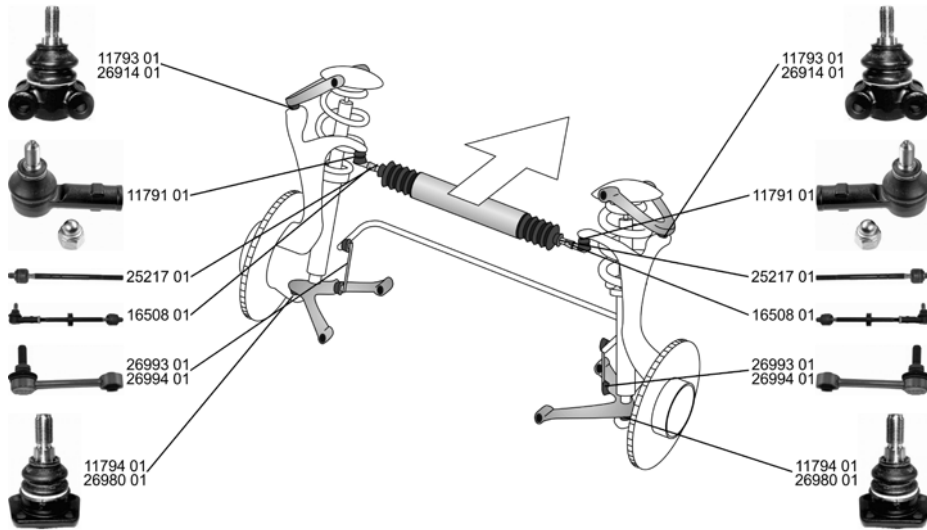

















JAGUAR

XJ (NAW, NBW)

07.97 - 05.03







	Spurstange / Rod Assembly für / for: ZF ALL TYPES	(27) (116)		16508 01 JLM 409 
	Spurstangenkopf / Tie Rod End mit Rechtsgewinde / with right-hand thread Gewindemaß / Thread Size: M14x1,5 ALL TYPES	(28) (206) (63)		11791 01 JLM 9660 
	Axialgelenk, Spurstange / Tie Rod Axle Joint mit Rechtsgewinde / with right-hand thread Gewindemaß / Thread Size: M14x1,5 ALL TYPES	(5) (206) (63)		25217 01 JLM 409 
	Faltenbalg, Lenkung / Bellow, steering Innendurchmesser 1 [mm] / Inner Diameter 1 [mm]: 13 Innendurchmesser 2 [mm] / Inner Diameter 2 [mm]: 57 ALL TYPES	(7) (72) (73)		34939 01 JLM 20683 
	Trag-/Führungsgelenk / Ball Joint ALL TYPES	(32)		11793 01 CAC 9938 
	Trag-/Führungsgelenk / Ball Joint ALL TYPES	(32)		11794 01 JLM 11860 
	Trag-/Führungsgelenk / Ball Joint Konusmaß [mm] / Cone Size [mm]: 16 ohne Befestigungsmaterial / Without fastening material ALL TYPES	(32) (77) (225)	 Chass. 812317 - Chass. F59525	26914 01 JLM 21380 
	Trag-/Führungsgelenk / Ball Joint ALL TYPES	(32)	 Chass. 812317 - Chass. F59525	26980 01 MNC 1350AA 



Ref.









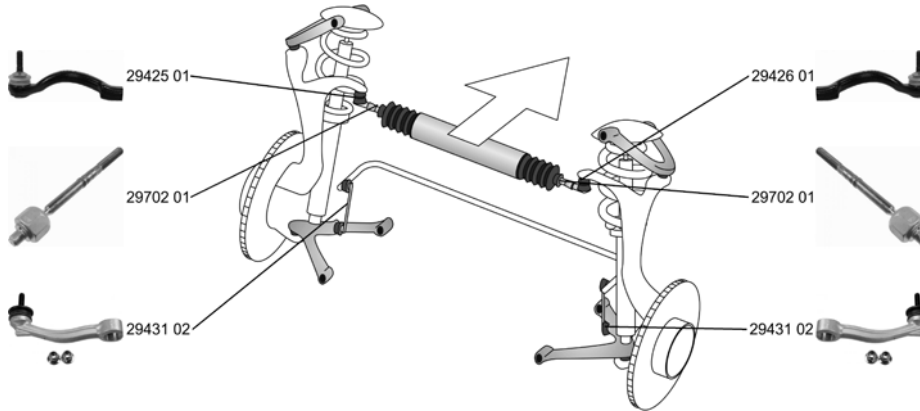



JAGUAR

XJ (NAW, NBW) 07.97 - 05.03

	Stange/Strebe, Stabilisator / Link Stabiliser Koppelstange / Coupling Rod	(31) (79)	↔	26993 01	MJA 2105AG
	ALL TYPES				
					->Chass. 853935
	Stange/Strebe, Stabilisator / Link Stabiliser Koppelstange / Coupling Rod	(31) (79)	↔	26994 01	MNC 2105AA
	ALL TYPES				
					Chass. 853936->

XJ (X350, X358) 05.03 -















	Spurstangenkopf / Tie Rod End radseitig / Wheel Side Innengewinde [mm] / Inner Thread [mm]: M14x1,5 Gewindemaß / Thread Size: M12x1,75	(28) (233) (75) (63)	↖ ↗	29425 01	C2C 35783
	ALL TYPES				
	Spurstangenkopf / Tie Rod End radseitig / Wheel Side Innengewinde [mm] / Inner Thread [mm]: M14x1,5 Gewindemaß / Thread Size: M12x1,75	(28) (233) (75) (63)	↖ ↗	29426 01	C2C 20176
	ALL TYPES				
	Axialgelenk, Spurstange / Tie Rod Axle Joint radseitig / Wheel Side Gewindemaß / Thread Size: M16x1,5 Gewindemaß / Thread Size: M14x1,5	(5) (233) (63) (63)	↔ △	29702 01	C2C 29620 C2C 38669
	ALL TYPES				
	Lagerung, Lenker / Control Arm-Trailing Arm Bush für Querlenker / For control arm	(11) (180)	▽ ↔ ↕ ↗	29783 01	C2C 36029
	ALL TYPES				
					Chass. G00442->
	Lagerung, Lenker / Control Arm-Trailing Arm Bush für Querlenker / For control arm	(11) (180)	▽ ↔ ⊕ ↗	29784 01	C2C 4437
	ALL TYPES				
					Chass. G00442->
	Lagerung, Lenker / Control Arm-Trailing Arm Bush für Querlenker / For control arm	(11) (180)	▽ ↔ ⊕ ↗	29785 01	C2C 4438
	ALL TYPES				
					Chass. G00442->





JAGUAR

XJ (X350, X358) 05.03 -

	Stange/Strebe, Stabilisator / Link Stabiliser ohne Zubehör / Without accessories Koppelstange / Coupling Rod	(31) (231) (79)	↔		29431 02 C2C 39468
	ALL TYPES				
	Achskörperlager / Hub Carrier Bush	(1)	↕		29781 01 C2C 2941
	ALL TYPES		Chass. G00442->		
	Achskörperlager / Hub Carrier Bush	(1)	↕		29782 01 C2C 2942
	ALL TYPES		Chass. G00442->		
	Spurstange / Rod Assembly	(27)	↔		33590 01 C2C 36985
	ALL TYPES		Chass. G00442->		
	Stange/Strebe, Stabilisator / Link Stabiliser Pendelstange / Suspension Rod	(31) (95)	↻		29427 01 C2C 18572
	ALL TYPES		Chass. G00442->		
	Stange/Strebe, Stabilisator / Link Stabiliser Pendelstange / Suspension Rod	(31) (95)	↻		29428 01 C2C 18571
	ALL TYPES		Chass. G00442->		

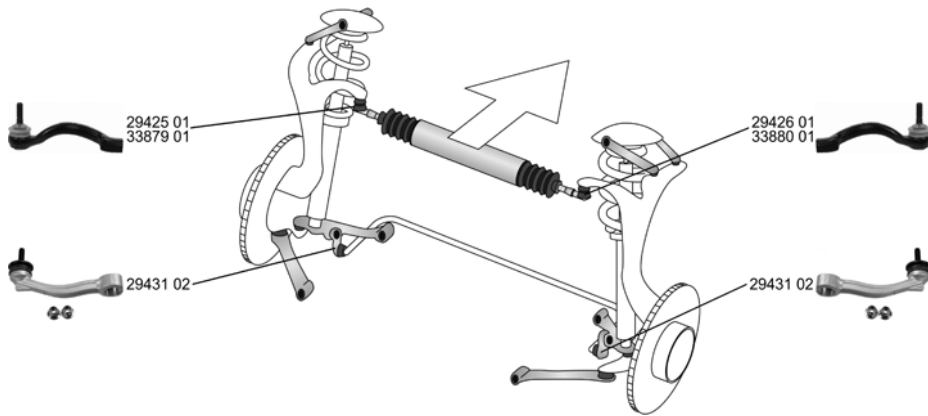
XK Coupe 03.06 -





























	Spurstangenkopf / Tie Rod End radseitig / Wheel Side Innengewinde [mm] / Inner Thread [mm]: M14x1,5 Gewindemaß / Thread Size: M12x1,75	(28) (233) (75) (63)	↻		29425 01 C2C 35783
	3.5 XK 4.2 XK8 4.2 XKR, 291 kW 4.2 XKR, 306 kW 5.0 V8	07.07 - 03.06 - 03.06 - 03.06 - 01.09 -			



JAGUAR







XK Coupe 03.06 -

 Spurstangenkopf / Tie Rod End radseitig / Wheel Side Innengewinde [mm] / Inner Thread [mm]: M14x1,5 Gewindemaß / Thread Size: M12x1,75	(28) (233) (75) (63)		29426 01 C2C 20176 
	3.5 XK 07.07 - 4.2 XK8 03.06 - 4.2 XKR, 291 kW 03.06 - 4.2 XKR, 306 kW 03.06 - 5.0 V8 01.09 -	->Chass. B32752	
 Spurstangenkopf / Tie Rod End Innengewinde [mm] / Inner Thread [mm]: M14x1,5 Aussengewinde [mm] / Outer Thread [mm]: M14x2	(28) (75) (41)		33879 01 C2Z 5518 
	3.5 XK 07.07 - 4.2 XK8 03.06 - 4.2 XKR, 291 kW 03.06 - 4.2 XKR, 306 kW 03.06 - 5.0 V8 01.09 -	Chass. B32753->	
 Spurstangenkopf / Tie Rod End Innengewinde [mm] / Inner Thread [mm]: M14x1,5 Aussengewinde [mm] / Outer Thread [mm]: M14x1,5	(28) (75) (41)		33880 01 C2Z 5517 
	3.5 XK 07.07 - 4.2 XK8 03.06 - 4.2 XKR, 291 kW 03.06 - 4.2 XKR, 306 kW 03.06 - 5.0 V8 01.09 -	Chass. B32753->	
 Lagerung, Lenker / Control Arm-Trailing Arm Bush für Querlenker / For control arm	(11) (180)		29785 01 C2C 4438 
	3.5 XK 07.07 - 4.2 XK8 03.06 - 4.2 XKR, 291 kW 03.06 - 4.2 XKR, 306 kW 03.06 - 5.0 V8 01.09 -		
 Stange/Strebe, Stabilisator / Link Stabiliser ohne Zubehör / Without accessories Koppelstange / Coupling Rod	(31) (231) (79)		29431 02 C2C 39468 
	3.5 XK 07.07 - 4.2 XK8 03.06 - 4.2 XKR, 291 kW 03.06 - 4.2 XKR, 306 kW 03.06 - 5.0 V8 01.09 -		
 Lagerung, Radlagergehäuse Bearing, wheel bearing housing Querlenker / Control Arm Bohrung-Ø [mm] / Bore Ø [mm]: 14	(12) (96) (44)		35353 01 C2C 36866 
	ALL TYPES ausser/except for : 5.0 XKR, 390 kW 09.10 - 5.0 XKR-S 01.11 -	Chass. B08196 - Chass. B37833	
 Spurstange / Rod Assembly	(27)		33590 01 C2C 36985 
	3.5 XK 07.07 - 4.2 XK8 03.06 - 4.2 XKR, 291 kW 03.06 - 4.2 XKR, 306 kW 03.06 - 5.0 V8 01.09 -	Chass. B00379->	
 Lenker, Radaufhängung / Track Control Arm Querlenker / Control Arm	(15) (96)		30633 01 C2P 13877 
	3.5 XK 07.07 - 4.2 XK8 03.06 - 4.2 XKR, 291 kW 03.06 - 4.2 XKR, 306 kW 03.06 - 5.0 V8 01.09 -		
 Lenker, Radaufhängung / Track Control Arm Querlenker / Control Arm	(15) (96)		30634 01 C2P 13876 
	3.5 XK 07.07 - 4.2 XK8 03.06 - 4.2 XKR, 291 kW 03.06 - 4.2 XKR, 306 kW 03.06 - 5.0 V8 01.09 -		











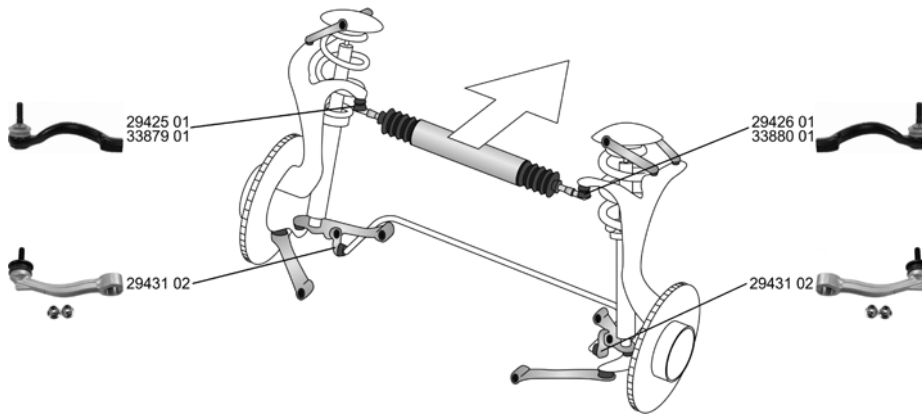







JAGUAR

XK Coupe 03.06 -

	Stange/Strebe, Stabilisator / Link Stabiliser Pendelstange / Suspension Rod	(31) (95)			29427 01 C2C 18572
	3.5 XK 4.2 XK8 4.2 XKR, 291 kW 4.2 XKR, 306 kW 5.0 V8	07.07 - 03.06 - 03.06 - 03.06 - 01.09 -			
	Stange/Strebe, Stabilisator / Link Stabiliser Pendelstange / Suspension Rod	(31) (95)			29428 01 C2C 18571
	3.5 XK 4.2 XK8 4.2 XKR, 291 kW 4.2 XKR, 306 kW 5.0 V8	07.07 - 03.06 - 03.06 - 03.06 - 01.09 -			

XK Cabriolet 03.06 -

















	Spurstangenkopf / Tie Rod End radseitig / Wheel Side Innengewinde [mm] / Inner Thread [mm]: M14x1,5 Gewindemaß / Thread Size: M12x1,75	(28) (233) (75) (63)			29425 01 C2C 35783
	3.6 4.2 XK8 4.2 XKR 5.0 V8	10.07 - 03.06 - 03.06 - 01.09 -			
	Spurstangenkopf / Tie Rod End radseitig / Wheel Side Innengewinde [mm] / Inner Thread [mm]: M14x1,5 Gewindemaß / Thread Size: M12x1,75	(28) (233) (75) (63)			29426 01 C2C 20176
	3.6 4.2 XK8 4.2 XKR 5.0 V8	10.07 - 03.06 - 03.06 - 01.09 -			
	Spurstangenkopf / Tie Rod End Innengewinde [mm] / Inner Thread [mm]: M14x1,5 Aussengewinde [mm] / Outer Thread [mm]: M14x2	(28) (75) (41)			33879 01 C2Z 5518
	3.6 4.2 XK8 4.2 XKR 5.0 V8	10.07 - 03.06 - 03.06 - 01.09 -			
	Spurstangenkopf / Tie Rod End Innengewinde [mm] / Inner Thread [mm]: M14x1,5 Aussengewinde [mm] / Outer Thread [mm]: M14x1,5	(28) (75) (41)			33880 01 C2Z 5517
	3.6 4.2 XK8 4.2 XKR 5.0 V8	10.07 - 03.06 - 03.06 - 01.09 -			
	Lagerung, Lenker / Control Arm-Trailing Arm Bush für Querlenker / For control arm	(11) (180)			29785 01 C2C 4438
	3.6 4.2 XK8 4.2 XKR 5.0 V8	10.07 - 03.06 - 03.06 - 01.09 -			



JAGUAR

XK Cabriolet 03.06 -

	Stange/Strebe, Stabilisator / Link Stabiliser ohne Zubehör / Without accessories Koppelstange / Coupling Rod	(31) (231) (79)	↔	29431 02 C2C 39468 
	3.6	10.07 -		
	4.2 XK8	03.06 -		
	4.2 XKR	03.06 -		
5.0 V8	01.09 -			
	Lagerung, Radlagergehäuse Bearing, wheel bearing housing Querlenker / Control Arm Bohrung-Ø [mm] / Bore Ø [mm]: 14	(12) (96) (44)	↔ ⊕	35353 01 C2C 36866 
	ALL TYPES		Chass. B08196 - Chass. B37833	
	Spurstange / Rod Assembly	(27)	↔	33590 01 C2C 36985 
	3.6	10.07 -	Chass. B00379->	
	4.2 XK8	03.06 -		
	4.2 XKR	03.06 -		
5.0 V8	01.09 -			
	Lenker, Radaufhängung / Track Control Arm Querlenker / Control Arm	(15) (96)	↗ ↻	30633 01 C2P 13877 
	3.6	10.07 -		
	4.2 XK8	03.06 -		
	4.2 XKR	03.06 -		
5.0 V8	01.09 -			
	Lenker, Radaufhängung / Track Control Arm Querlenker / Control Arm	(15) (96)	↗ ↻	30634 01 C2P 13876 
	3.6	10.07 -		
	4.2 XK8	03.06 -		
	4.2 XKR	03.06 -		
5.0 V8	01.09 -			
	Stange/Strebe, Stabilisator / Link Stabiliser Pendelstange / Suspension Rod	(31) (95)	↻	29427 01 C2C 18572 
	3.6	10.07 -		
	4.2 XK8	03.06 -		
	4.2 XKR	03.06 -		
5.0 V8	01.09 -			
	Stange/Strebe, Stabilisator / Link Stabiliser Pendelstange / Suspension Rod	(31) (95)	↻	29428 01 C2C 18571 
	3.6	10.07 -		
	4.2 XK8	03.06 -		
	4.2 XKR	03.06 -		
5.0 V8	01.09 -			









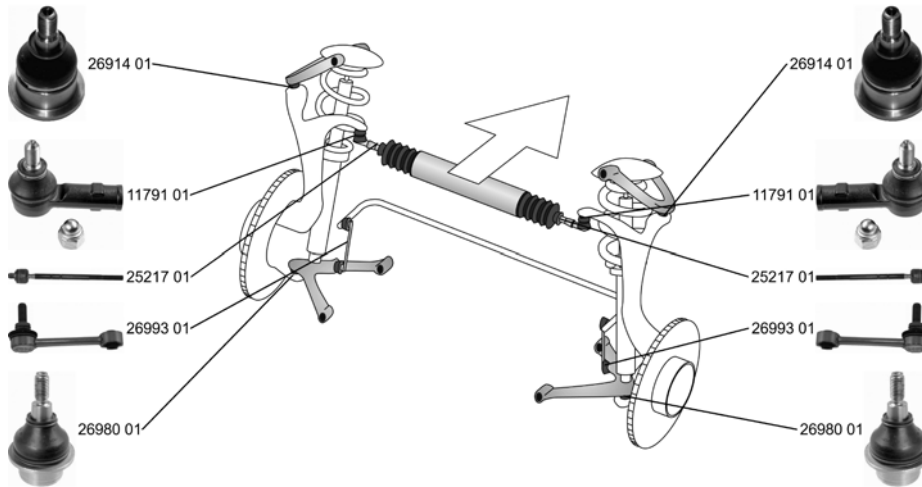







JAGUAR

XK 8 Coupe (QEV)

03.96 -





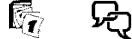





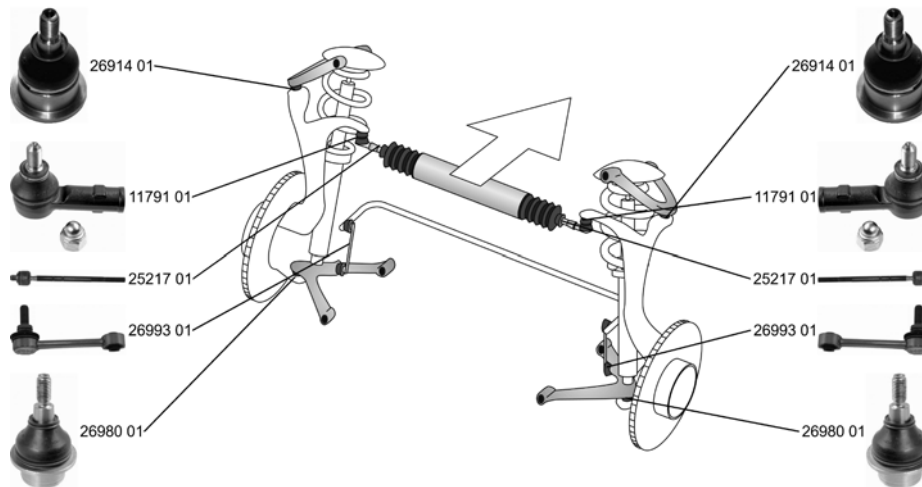









	Spurstangenkopf / Tie Rod End mit Rechtsgewinde / with right-hand thread Gewindemaß / Thread Size: M14x1,5	(28) (206) (63)		11791 01 JLM 9660 
	4.0, 209 kW	03.96 -		
	4.0, 267 kW	02.98 -		
	4.2	08.02 -		
	R 4,2	08.02 -		
	Axialgelenk, Spurstange / Tie Rod Axle Joint mit Rechtsgewinde / with right-hand thread Gewindemaß / Thread Size: M14x1,5	(5) (206) (63)		25217 01 JLM 409 
	4.0, 209 kW	03.96 -		
	4.0, 267 kW	02.98 -		
	4.2	08.02 -		
	R 4,2	08.02 -		
	Faltenbalg, Lenkung / Bellow, steering Innendurchmesser 1 [mm] / Inner Diameter 1 [mm]: 13 Innendurchmesser 2 [mm] / Inner Diameter 2 [mm]: 57	(7) (72) (73)		34939 01 JLM 20683 
	ALL TYPES		Chass. A00083->	
	Trag-/Führungsgelenk / Ball Joint Konusmaß [mm] / Cone Size [mm]: 16 ohne Befestigungsmaterial / Without fastening material	(32) (77) (225)		26914 01 JLM 21380 
	4.0, 209 kW	03.96 -		
	4.0, 267 kW	02.98 -		
	4.2	08.02 -		
	R 4,2	08.02 -		
	Trag-/Führungsgelenk / Ball Joint	(32)		26980 01 MNC 1350AA 
	ALL TYPES			
	Stange/Strebe, Stabilisator / Link Stabiliser Koppelstange / Coupling Rod	(31) (79)		26993 01 MJA 2105AG 
	4.0, 209 kW	03.96 -		
	4.0, 267 kW	02.98 -		
	4.2	08.02 -		
	R 4,2	08.02 -		



JAGUAR

XK 8 Convertible (QDV) 03.96 -



	<p>Spurstangenkopf / Tie Rod End mit Rechtsgewinde / with right-hand thread Gewindemaß / Thread Size: M14x1,5</p> <p>4.0, 209 kW 03.96 - 4.0, 267 kW 02.98 - 4.2 08.02 - R 4,2 08.02 -</p>	<p>(28) (206) (63)</p>	<p></p>	<p>11791 01 JLM 9660</p> 
	<p>Axialgelenk, Spurstange / Tie Rod Axle Joint mit Rechtsgewinde / with right-hand thread Gewindemaß / Thread Size: M14x1,5</p> <p>4.0, 209 kW 03.96 - 4.0, 267 kW 02.98 - 4.2 08.02 - R 4,2 08.02 -</p>	<p>(5) (206) (63)</p>	<p></p>	<p>25217 01 JLM 409</p> 
	<p>Faltenbalg, Lenkung / Bellow, steering Innendurchmesser 1 [mm] / Inner Diameter 1 [mm]: 13 Innendurchmesser 2 [mm] / Inner Diameter 2 [mm]: 57 ALL TYPES</p>	<p>(7) (72) (73)</p>	<p></p> <p>Chass. A00083-></p>	<p>34939 01 JLM 20683</p> 
	<p>Trag-/Führungsgelenk / Ball Joint Konusmaß [mm] / Cone Size [mm]: 16 ohne Befestigungsmaterial / Without fastening material</p> <p>4.0, 209 kW 03.96 - 4.0, 267 kW 02.98 - 4.2 08.02 - R 4,2 08.02 -</p>	<p>(32) (77) (225)</p>	<p></p>	<p>26914 01 JLM 21380</p> 
	<p>Trag-/Führungsgelenk / Ball Joint ALL TYPES</p>	<p>(32)</p>	<p></p>	<p>26980 01 MNC 1350AA</p> 
	<p>Stange/Strebe, Stabilisator / Link Stabiliser Koppelstange / Coupling Rod</p> <p>4.0, 209 kW 03.96 - 4.0, 267 kW 02.98 - 4.2 08.02 - R 4,2 08.02 -</p>	<p>(31) (79)</p>	<p></p>	<p>26993 01 MJA 2105AG</p> 