

Front Door Trim Panel 76.34.01

Removal

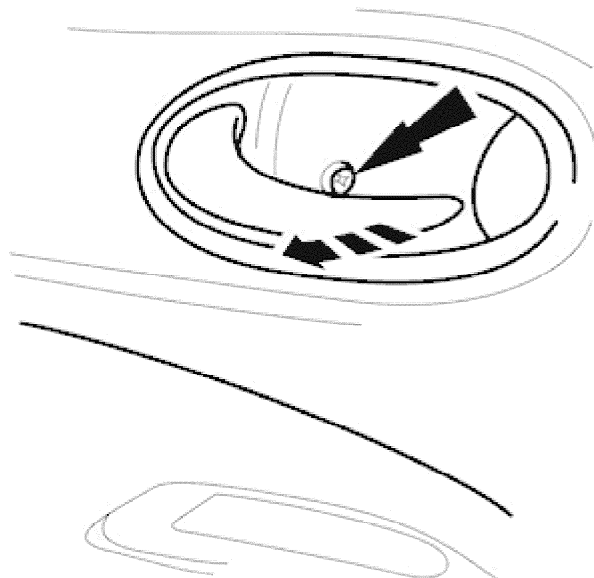

E36335

1. Remove interior door handle escutcheon.
 - Remove cover from door handle escutcheon securing screw and slacken and remove screw.
 - Pull door handle inwards and exercising care to avoid damaging tweeter, remove escutcheon from casing.
2. Remove door casing veneer panel. Refer to <<76.47.11>>.

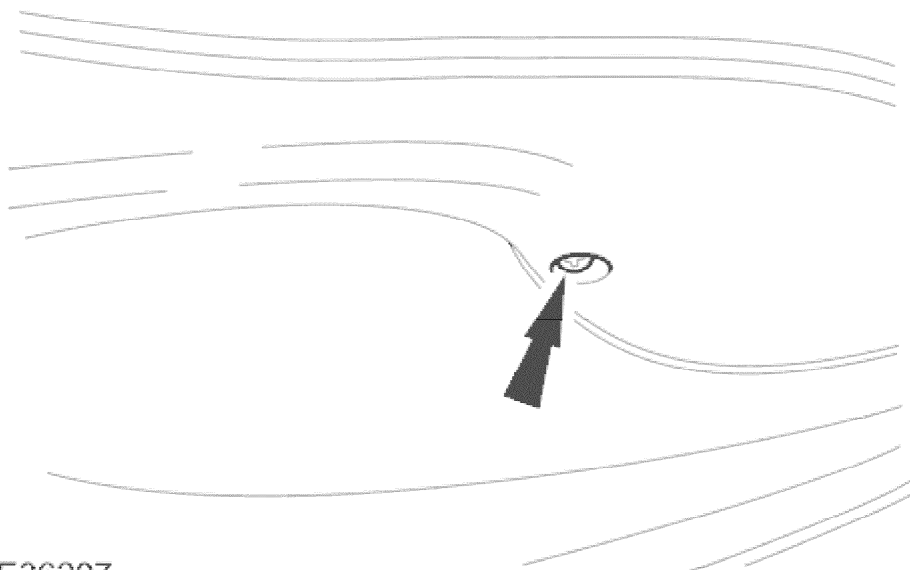

E36207

3. Slacken and remove the armrest centre securing screw.

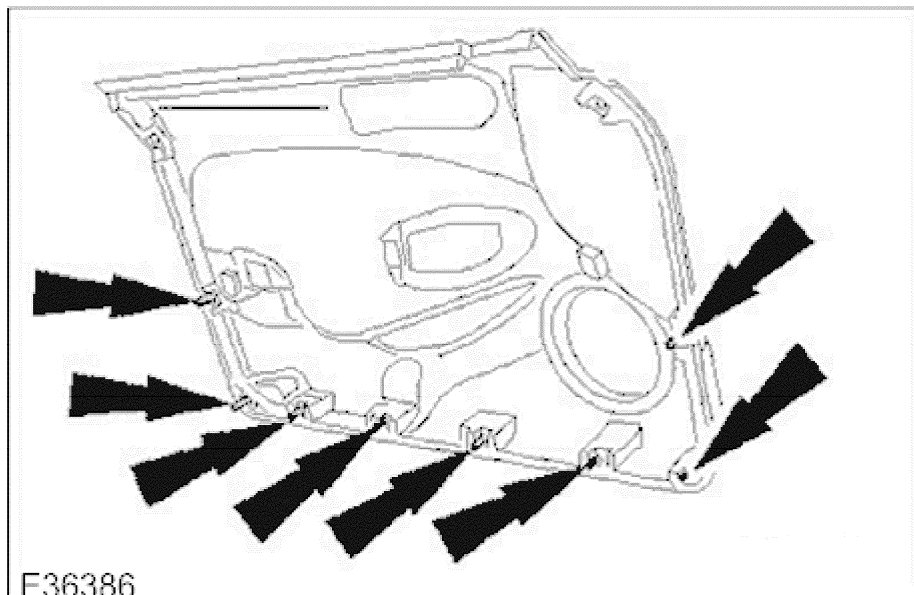

4. Carefully release the eight fasteners securing lower section of casing to door.

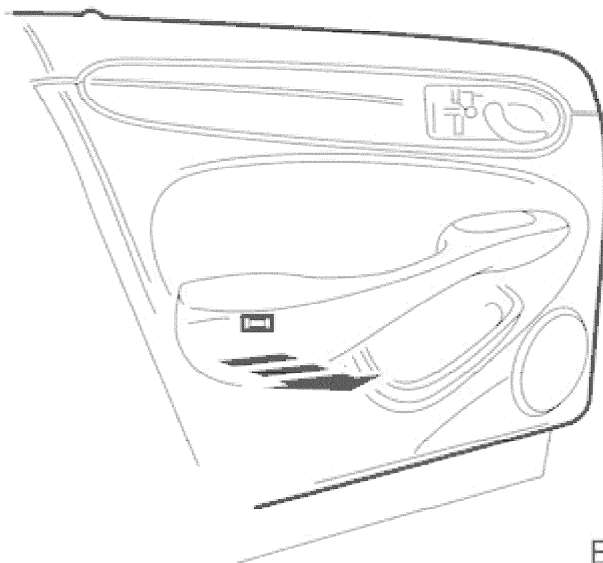

5. Lift rear edge of door casing to release retaining clip housing from door panel.

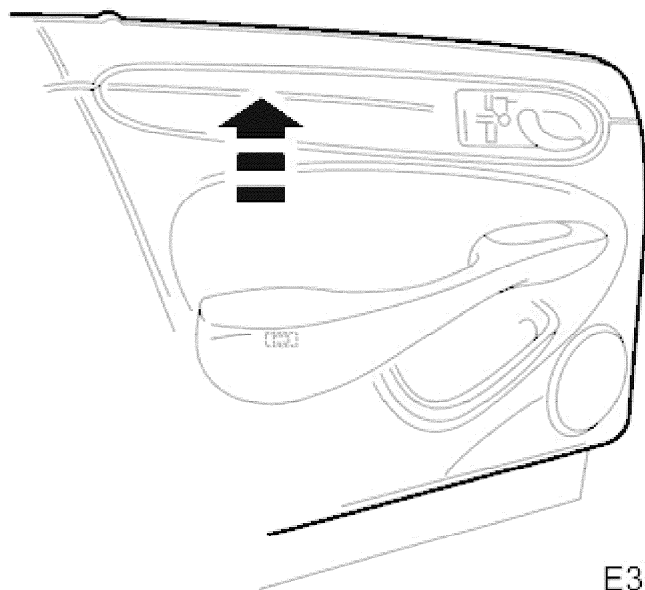

E35575

6. Lift casing clear of door waist flange and lock button and withdraw for access.
7. Using pliers, remove housing from clip and fit to door panel.

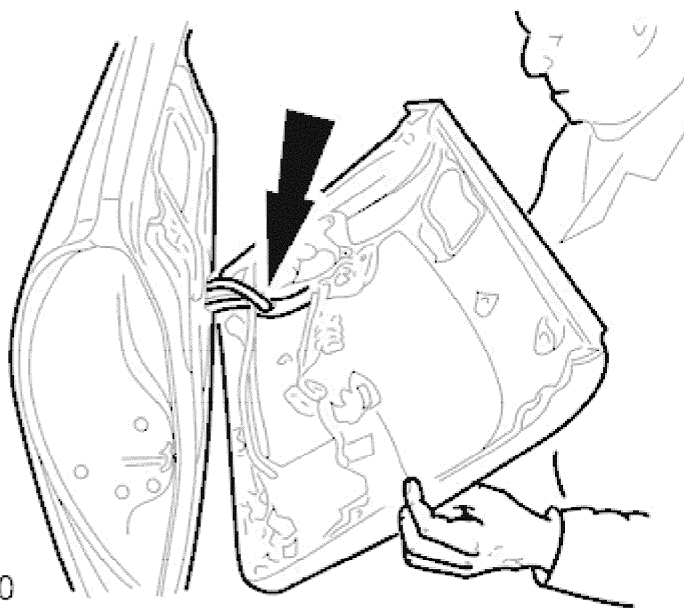

E36210

8. Disconnect tweeter, speaker, puddle lamp and switchpack harness multiplugs.
9. Remove armrest lower securing clip housing from casing. and refit to door.

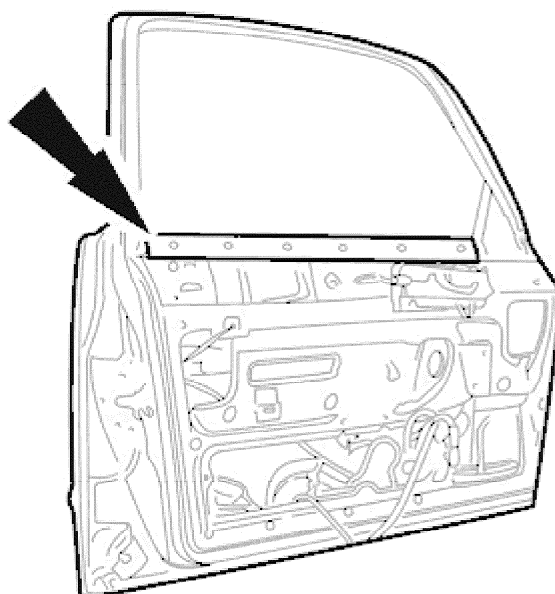

E36338

10. Remove door inner waist seal from holder, slacken and remove screws securing waist seal holder and remove seal holder.

11. Remove armrest from door casing. Refer to <<76.34.22>>.

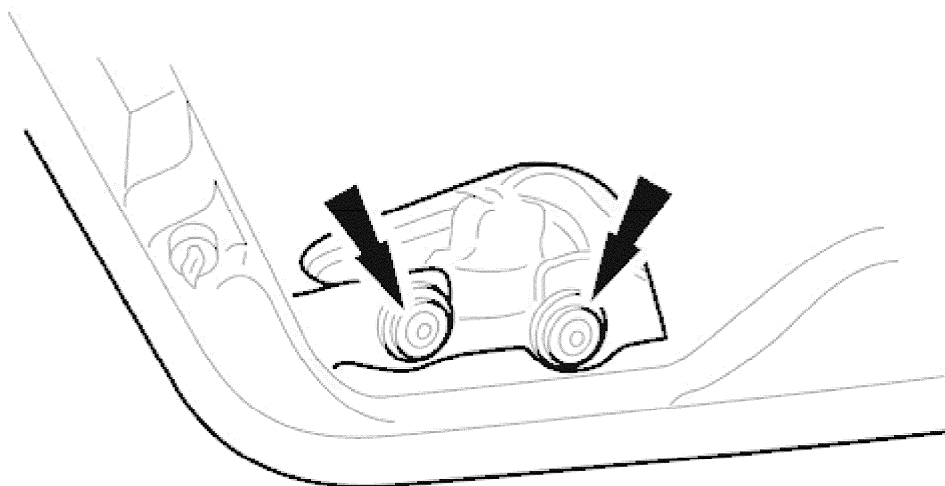

E36340

12. Slacken and remove puddle lamp securing screws and remove lamp assembly from casing.

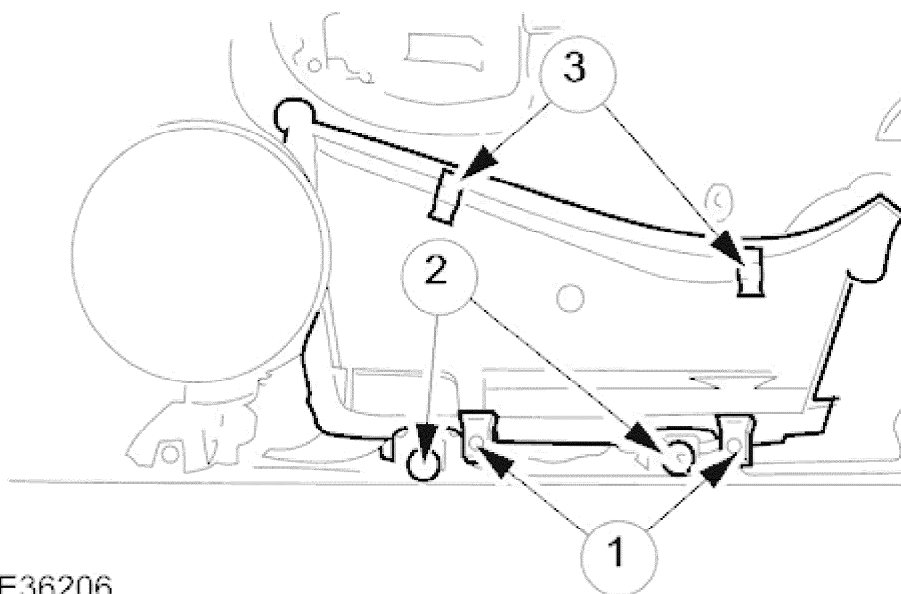

E36206

13. Remove pocket from door casing.
 1. Release puddle lamp harness from clips at base of door pocket.
 2. Slacken and remove the two screws securing bottom of pocket to casing.
 3. Remove two spring clips securing top of pocket to casing.

14. Lift pocket from casing.

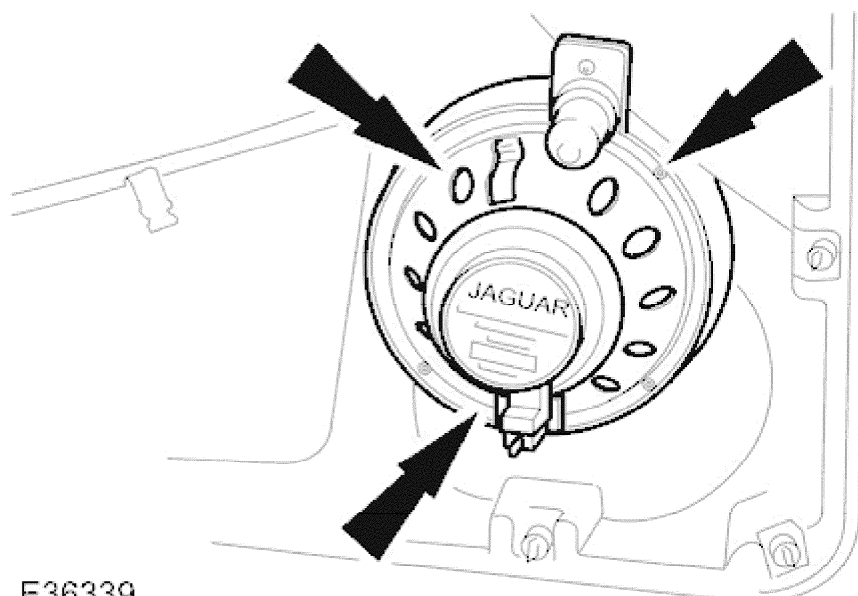

E36339

15. Slacken and remove door speaker securing screws and remove speaker from casing.

Installation

1. Fit and fully seat casing securing clips.
2. Position speaker grill in casing align speaker and fit and tighten securing screws.

2003 XJ RANGE - Interior Trim and Ornamentation - 501-05

3. Position pocket in casing and secure with screws and spring clips.
4. Fit puddle lamp to casing, fit and tighten securing screws and position harness in pocket clips.
5. Fit door armrest to casing. Refer to <<**76.34.23**>>.
6. Fit inner waist seal holder to casing and fit and tighten the securing screws.
7. Align and fit inner waist seal.
8. Fit door armrest to casing. Refer to .
9. Check that armrest tang locator and screw insert are correctly positioned in door panel.
10. Position casing for access and connect tweeter, speaker, puddle lamp and switchpack harnesses.
11. Finally position casing locating fold over waist flange and firmly press armrest to locate retaining tang in door panel.
12. Commencing at front, press and firmly seat casing lower fasteners in door inserts.
13. Fit and tighten armrest centre securing screw in door insert.
14. Fit door casing veneer panel. Refer to <<**76.47.11**>>.
15. Position door handle escutcheon on casing, fit and tighten securing screw and fit cover over screw.