

BILSTEIN SHOCK ABSORBERS

MOTORSPORTS



Mooresville, NC Facility



Poway, CA Facility

Aftermarket & Motorsports – East
Mooresville, NC
Tech Hotline: 877-666-7662

Aftermarket & Motorsports – West
Poway, CA
Phone: 800-537-1085

bilsteinUS.com

Distributed By:

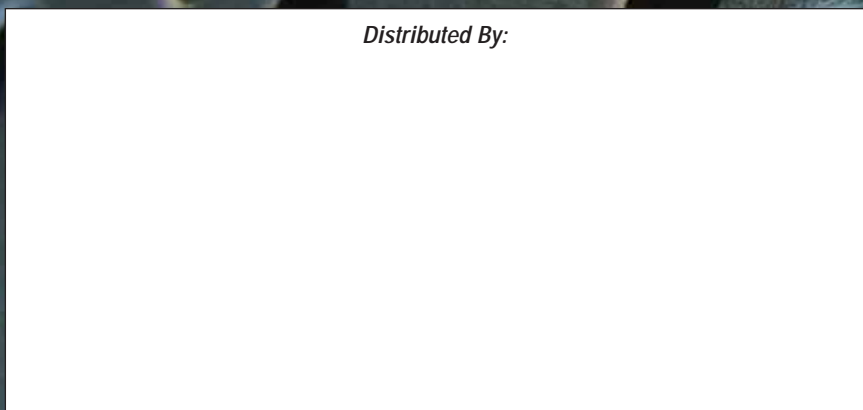

Printed in U.S.A.

© 2009

PP2450 1109

A company of
ThyssenKrupp Technologies

Bilstein Gas Pressure Shock Absorbers
ThyssenKrupp Bilstein of America



Bilstein Gas Pressure Shock Absorbers
ThyssenKrupp Bilstein of America





Motorsports Shocks



Model	Application	Description	Page
AK Series	Pure stock, Enduro, Street Stock (stock mount), Mini-Stock	36mm/46mm diameter sealed steel body stock mount shocks and struts	8 - 9
SG Series	Stock Cars, IMCA/UMP Modifieds, Midgets, Mini-Sprints, Modified Lites and Dwarf Cars	36mm diameter sealed steel body, converts to coilover applications	10
SZ Series SL Series SLS Series	Modifieds, Late Models and Stock Cars/Hobby Stocks	46mm diameter sealed steel body, converts to coilover applications, off the shelf valvings	11 - 13
SN Series SNS Series	Modifieds, Late Models and Sprint Cars	46mm diameter steel body, aluminum billet cap with schrader valve, linear or digressive piston, rebuildable	14
ASB Series	Sprint Cars, Midgets, Mini-Sprints, TQ Midgets, Micro-Midgets and Formula Cars	Ultra lightweight 36mm aluminum body, sealed non-coilover design or rebuildable threaded body models available	15
ASN Series	Modifieds, Late Models and Sprint Cars	46mm diameter threaded aluminum body with schrader valve and circlip rod guide, linear or digressive piston, rebuildable, optional adjustable shaft	16
BGT Series	Late Models, Super Late Models, Sprint Cars, Dirt Late Models and Big Block Modifieds	46mm diameter threaded aluminum body with 60mm nitrogen compartment, 14mm piston shaft, rebuildable	17
Big Track Series	Rebuildable shocks for NASCAR classes	B46-60BG8 – 46mm aluminum body with 60mm gas chamber, linear, digressive or RBT piston, screw in rod guide B46-GN3 – 46mm aluminum body, linear, digressive or RBT piston, screw in rod guide, optional adjustable shaft	18

Table of Contents

Page 4 Monotube vs. Twin-Tube Shocks

Page 5 Why Race On Bilstein Shock Absorbers, Q & A

Page 6 Bilstein Pistons and Valves

Page 7 Tools and Accessories

Page 8-9 AK Series, Mounting Types and Specs / AK Packages

Page 10 SG Series

Page 11 SZ Series

Page 12 SL Series

Page 13 SLS Series **NEW**

Page 14 SN & SNS Series

Page 15 ASB Series

Page 16 ASN Series

Page 17 BGT Series

Page 18 Big Track Series

Page 19 Adjustable Shafts and Compression Canister

Page 20 Dwarf Car Set-Ups

Page 21 Micro Midget and Modified Midget Set-Ups

Page 22 Midget and Mini Sprint Set-Ups

Page 23 Sprint Car Set-Ups

Page 24 Stock Car / Hobby Stock Set-Ups

Page 25 I.M.C.A. Type Modified Dirt Set-Ups

Page 26 Dirt Modified Set-Ups

Page 27 Super Dirt Late Model Set-Ups

Page 28 I.M.C.A. Type Modified Asphalt Set-Ups

Page 29 Asphalt Modified Set-Ups

Page 30 Late Model Stock / Super Late Model Asphalt Set-Ups

Page 31 How To Shock Tune Your Chassis, Trouble Shooting The Car At The Track

For Complete Information Contact:

Aftermarket & Motorsports – East
 Mooresville, NC
 Phone: 877/666-7662

Aftermarket & Motorsports – West
 Poway, CA
 Phone: 800/537-1085

bilsteinUS.com



Monotube vs. Twin-Tube



There are two basic types of shock absorber used in today's short track racing: the conventional twin-tube reservoir shock and the monotube gas pressure shock pioneered by Bilstein.

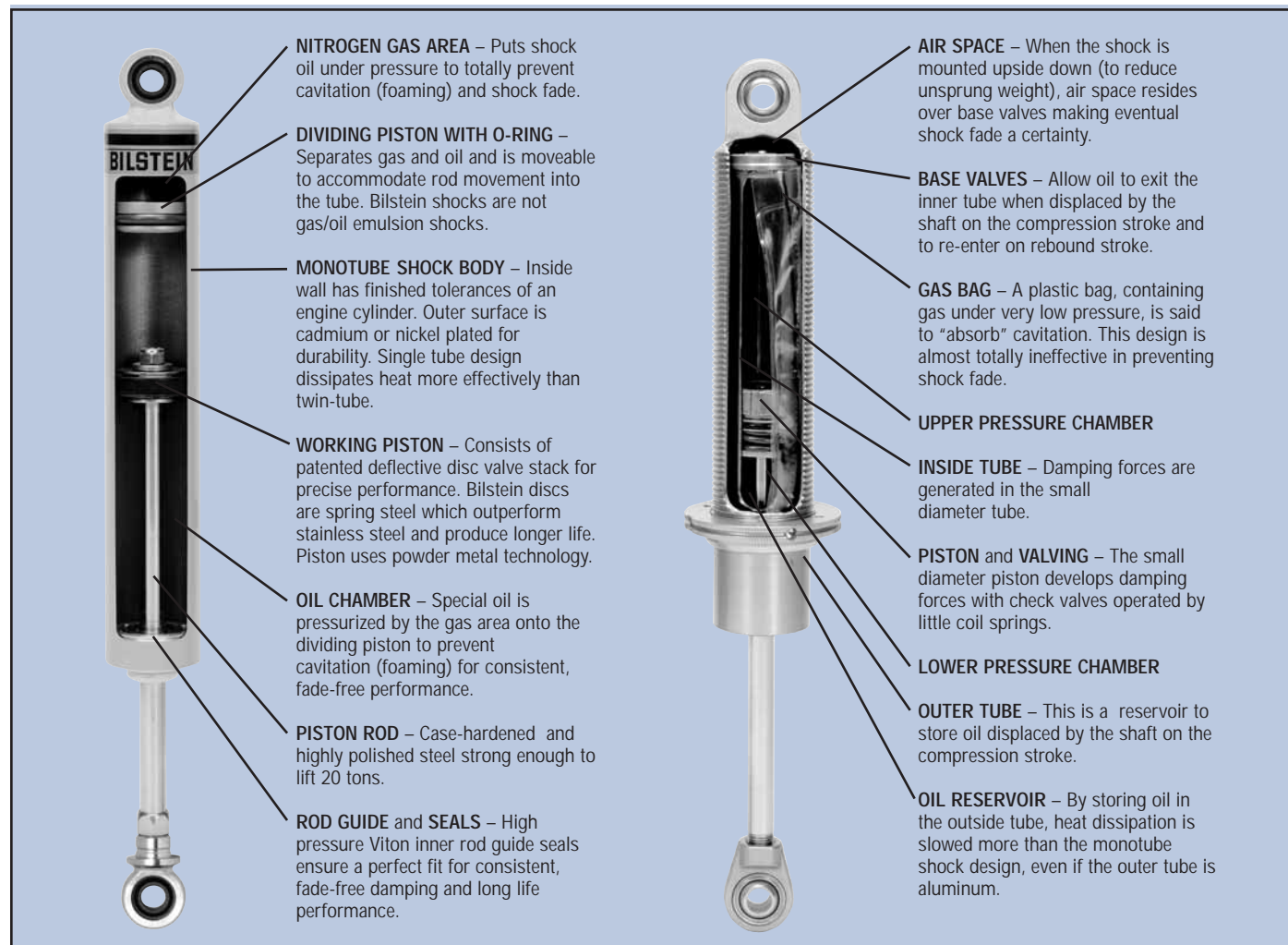

Most short track racers still run on the older style, twin-tube shocks. But if you watch closely, you'll find more of your competitors switching to the up-to-date, monotube gas pressure shock absorbers. Although there are other brands of monotube gas shocks making an appearance in America's pit areas, Bilstein technology is so far ahead and so different, that their performance cannot be equaled.

Bilstein's larger piston area produces instantaneous response to the slightest suspension movements. Dead spots in a Bilstein are an impossibility.

Deflective disc valving in Bilstein shocks eliminate the need for check valves and tiny coil springs that cause inconsistencies in shock valving. All Bilstein shocks of the same part number produce, with little variation, the same damping forces. In other

words, when you bolt on a Bilstein, you know what shock valving is on your car.

Shock absorber performance fades away when the oil in the shock cavitates (foams). Conventional twin-tube shocks, that are called “gas charged,” contain a small plastic bag holding a minuscule amount of gas under a small amount of pressure. This design, while low in cost to manufacture, is ineffective on the track.

Under extreme G-forces, on rough tracks and in high heat conditions, “gas charged” twin-tube shocks do not resist cavitation as effectively as monotube gas pressure shock absorbers. This is the reason that all NASCAR, Indy Car, Formula One and Off-Road racers long ago discarded twin-tube shocks in favor of monotube gas pressure technology!

Why Race On Bilstein Shock Absorbers?

1. Because the valvings are consistent, your set-ups will be more precise.
2. Bilstein's larger piston and deflective disc valving develop control force when you need it, at the slightest movement of the suspension. You'll get weight transfer when you need it, better control under braking and your tires will stay on the track through the rough spots.
3. Bilstein shocks don't fade. Your chassis will handle as good at the end of the race as it did at the start.
4. Bilstein shocks are rugged. They last for years and are rebuildable and revalvable.
5. When the advantages of Bilstein gas pressure shocks are tallied up, you will have spent less money on shock absorbers and collected more money at the pay window.

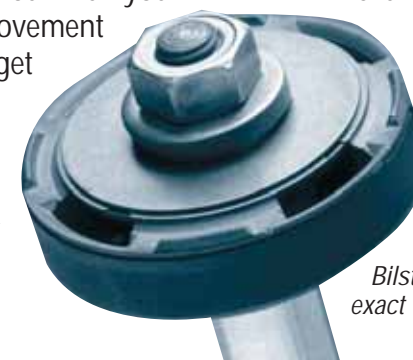

Bilstein's unique deflective disc valving system allows for exact valving of both compression and rebound movements.

ANSWERING THE RACERS' QUESTIONS

The following are some commonly asked questions and their corresponding answers concerning Bilstein monotube gas pressure shock absorbers:

Q. Why is the shaft on a Bilstein shock always extended?

A. As monotube gas shocks, Bilstein shocks are under gas pressure to deliver the most responsive valving for ultimate control. This pressure, called the gas reactive force, and Bilstein's perfect internal seals force the shaft to be extended.

Q. Is the car more difficult to scale with Bilstein shocks?

A. Bilstein shocks have no effect on the results as you weigh the four corners. The gas reactive force in Bilstein shocks may raise your car's ride height slightly. Simply adjust the chassis downward to the desired ride height.

Q. Does Bilstein offer specific applications for the various dirt and asphalt racing series?

A. As the set-up charts in this catalog indicate, Bilstein has shocks specifically valved for both dirt and asphalt surfaces of various track lengths.

Q. Are Bilstein shocks difficult to understand and use?

A. After reviewing the various set-ups in this catalog, you'll be ready to select the proper shocks for your specific race car. Bilstein valving is precise. Once you purchase your Bilstein shocks, you can be certain they will perform at peak efficiency throughout their long life.

Q. I can buy twin-tube shocks for less money than Bilstein shocks. Why should I spend the extra money?

A. As we point out in this catalog, Bilstein shocks are fabricated from the highest quality components for long life performance. Typically, Bilstein shocks are only slightly more expensive than twin-tube brands. Since they will far outlast conventional shocks, Bilstein shocks cost much less over the long run. Bilstein shocks are the least expensive way to lower your lap times.

Q. The companies that sell only twin-tube (low pressure gas) shocks say their design outperforms monotube (high pressure gas) shocks. How can I know the truth?

A. Take a trip to a local discount department store that sells replacement shocks for cars and trucks that drive on the street. You'll find shocks priced from about \$8.99 to \$29.99. All of the shocks on display will be twin-tube shocks. Their price reflects the fact that twin-tube technology is relatively unsophisticated and very low cost to produce. At a new car dealership you'll find that low cost base line cars and trucks are factory equipped with twin-tube shocks that add very little to the cost of the vehicle. Factory installed Bilstein shocks can also be found on Mercedes-Benz, Ferrari, Porsche, Toyota TRD, Roush and many other high performance vehicles around the world. Finally, take a stroll through the pit area at a NASCAR Cup, Busch, Craftsman Truck, CART, IRL or Formula One race and you'll find not a twin-tube shock in sight! The top racing engineers in the world always use monotube gas shocks! By searching out the facts, you will know the truth...and the truth will make you faster!



Bilstein Pistons and Valves

Shock absorbers produce damping force by forcing oil, under pressure, through holes in the piston. Shock damping forces increase as the vertical velocity of your suspension increases. In other words, when the shock's piston speed through the oil increases, so do the damping forces. Shock dynamometers measure the amount of damping force generated by the piston as it accelerates and decelerates from a dead stop to a chosen peak velocity (usually 10" to 12" per second). The forces are normally depicted in the form of a graph that plots shaft velocity, in inches per second, on the horizontal, and damping forces in pounds on the vertical. Compression forces are normally expressed from zero going up, and rebound forces from zero

going down, although that can be reversed by the "dyno" operator with a single key stroke. Below, study the shock dyno graphs that illustrate the different style performance curves using two, unique piston designs, available from Bilstein.

Bleed: The flow of oil through the holes in the piston is referred to as "bleed", or sometimes as "bypass". The bleed characteristic in the shock's piston design determines the amount of "slow piston speed" control available before the shock's valving comes into effect to control forces developed at higher velocities. High bleed pistons create small amounts of damping force at low piston speeds, and low bleed pistons create large amounts of damping force at low piston speeds.

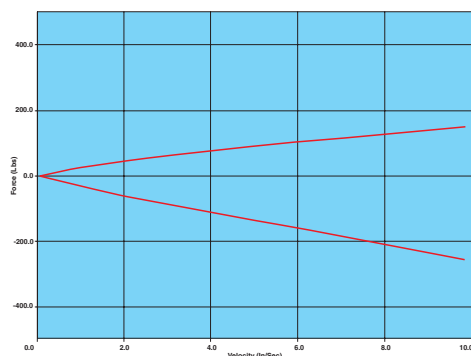

This graph was generated by a Bilstein U37T linear piston using 36.4 mm diameter cover plates resulting in a high bleed (or high frequency) style, short track linear valving.

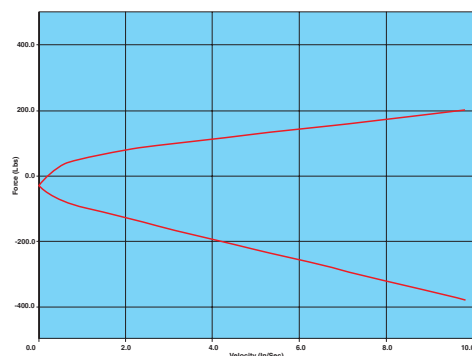

This graph depicts the Bilstein U37T linear piston combined with 37.4 mm cover plates. The result is valving with more "low-speed" control.

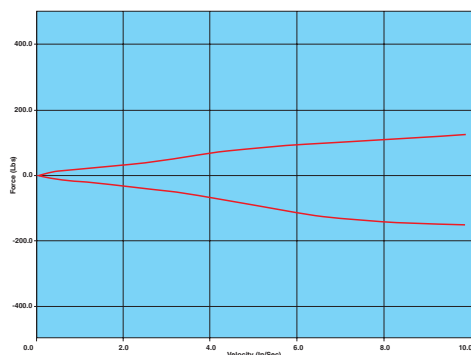

Our standard digressive valvings can be built with a wide range of bleed patterns. The one shown here is a very high bleed valving typical of one that would be used on the rear suspension to promote traction.

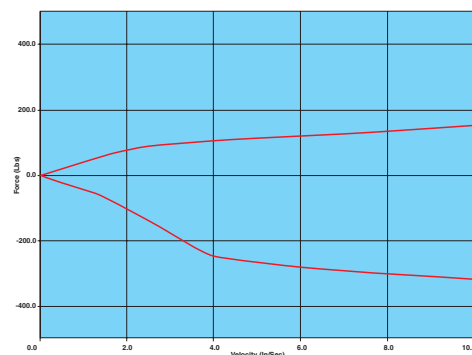

Shown here is a standard digressive valving using a low amount of bleed. Notice the large amount of force developed on both compression and rebound at slow piston speeds.

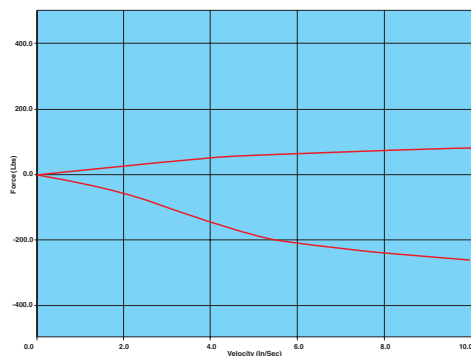

The new Bilstein "COB" Digressive piston utilizes a check valve, that when installed on the compression side of the piston creates less bleed and therefore more force on the rebound side.

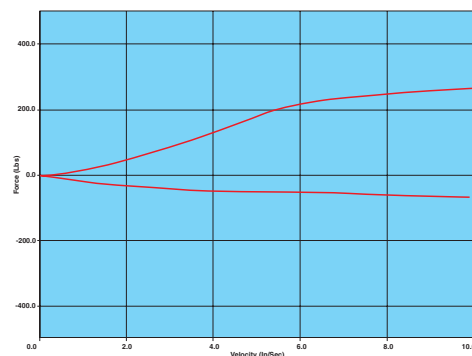

When the "COB" Digressive piston's check valve is installed on the rebound side, there is less bleed and therefore more force created on the compression side.

Tools And Accessories



Fill kit #192116



Linear valving kit #B4-BOA-0000149



Disassembly collar #B4-BOA-0000287

Product	Part Number
Fill kit	192116
Disassembly collar	B4-BOA-0000287
Service manual	194000
36mm assembly wrench	E4-XS1-Z002A00
46mm assembly wrench	193070
Shock oil (gallon)	193031
Digressive valving kit	B4-BOA-0000150 (2 boxes)
Linear valving kit	B4-BOA-0000149 (2 boxes)
14mm steel assembly needle	E4-BOA-0000560
46mm slide-on coilover kit	B4-BOA-0000117
46mm aluminum coilover kit	B4-BOA-0000190
46mm gas fill tool	193000
36mm slide-on coilover kit	B4-BOA-0000187
36mm aluminum coilover kit	B4-BOA-0000257
36mm gas fill tool	B4-BOA-0000259
46mm composite wear sleeve (ASN & BGT Series)	E4-R00-Z016A00
36mm composite wear sleeve (ASB Series)	E4-R00-Z016A01



AK Series

AK Series Specifications



Year	Front Part Number	Rear Part Number
CAMARO		
70-76	AK2072	AK1054
77-81	AK1053	AK1054
82-92	AK1049	AK1050
CHEVELLE		
73-83	AK1043	AK1044
73-83	AK1051	AK1052
73-83	AK3050F	AK2020R
73-83	AK3060F	AK2040COBR
73-83	AK4040F	AK3030R
73-83	AK5555F	AK5030R
73-83	AK6565F	AK6010COBR
MONTE CARLO-BUICK REGAL		
73-88	AK1043	AK1044
FULL SIZE FORD		
79-93	AK1195	AK1196
MUSTANG (except SVO)		
87-93	AK1199	AK1198

Race Shock Kit Packages

These shock kit packages are perfect for dialing in your car. Everything is included...the shocks, instructions and recommended set-ups.

Kits include 7 AK Series shocks:

- Dirt Stock Car (metric) #F4-SE7-F565-MO
- Sport Modified (metric) #F4-SE7-F566-MO



Mounting Types (Extended and Compressed Lengths)

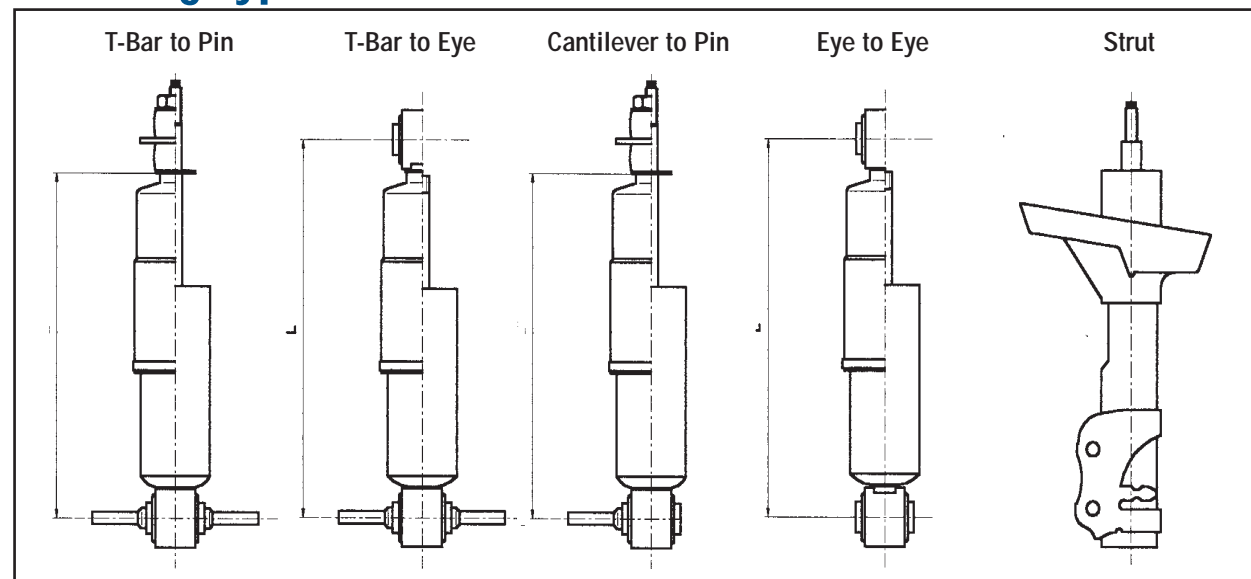

Part Number	Valving	Mounting Types	Extended Length	Collapsed Length
AK1043	358# / 219# linear	T-Bar to Pin	13.48"	8.60"
AK3050F	131# / 206# digressive	T-Bar to Pin	13.48"	8.60"
AK3060F	110# / 233# digressive	T-Bar to Pin	13.48"	8.60"
AK4040F	197# / 154# digressive	T-Bar to Pin	13.48"	8.60"
AK5555F	245# / 190# digressive	T-Bar to Pin	13.48"	8.60"
AK6565F	325# / 220# digressive	T-Bar to Pin	13.48"	8.60"
AK1044	254# / 141# linear	T-Bar to Cantilever	20.31"	13.11"
AK2020R	70# / 70# digressive	T-Bar to Cantilever	20.31"	13.11"
AK2040COBR	70# / 140# digressive	T-Bar to Cantilever	20.31"	13.11"
AK3030R	158# / 117# digressive	T-Bar to Cantilever	20.31"	13.11"
AK5030R	300# / 120# digressive	T-Bar to Cantilever	20.31"	13.11"
AK6010COBR	185# / 70# digressive	T-Bar to Cantilever	20.31"	13.11"
AK1049	196# / 125# linear	Strut	19.98"	14.41"
AK1050	213# / 118# linear	Pin to Cantilever	18.90"	11.81"
AK1051	393# / 172# linear	T-Bar to Pin	11.93"	7.95"
AK1052	324# / 112# linear	T-Bar to Cantilever	18.62"	11.28"
AK1053	565# / 164# linear	T-Bar to Pin	14.11"	9.21"
AK1054	165# / 67# linear	T-Bar to Pin	20.39"	12.72"
AK1195	577# / 359# digressive	T-Bar to Pin	13.86"	9.21"
AK1196	310# / 130# digressive	Cantilever to Pin	19.80"	12.34"
AK1198	152# / 103# linear	Pin to Eye	20.16"	12.64"
AK1199	224# / 122# linear	Strut	21.28"	15.94"
AK2072	381# / 233# linear	T-Bar to Pin	14.02"	8.92"

All valvings at 10"/sec.

NOTE: See page 8 for mounting types



SG Series

Designed for, but is not limited to, Stock Cars, IMCA/UMP Modifieds, Midgets, Mini-Sprints, Modified Lites and Dwarf Cars.

36mm (1.42") diameter steel, sealed monotube gas pressure shock.

- Converts to coilover applications
- Economy price
- Lightweight
- Low rod pressure
- Bilstein's famous consistent, fade-free performance

Available in 6", 7" and 8" strokes:

Model	Extended Length	Collapsed Length
S6G	17.00"	11.00"
S7G	20.00"	12.00"
S8G	21.00"	13.00"

Available in these standard valvings:
(Example: S6G-3060 or S7G-5555)

1030	3060	5555
1090	3535	6020**
2020	4010	6035*
2040	4020	6565
3010	4040	7035*
3020	4545	8035*
3030	5030	9010
3050	5050	

* Built with COB piston for strong "tie-down"

** High bleed valving designed for rear



SZ Series

Designed for, but is not limited to, Modifieds and Late Models.

46mm (1.81") diameter steel, sealed monotube gas pressure shock.

- Converts to coilover applications
- Plated for durability and rapid heat dissipation
- Bilstein's famous consistent, fade-free performance
- Custom valving is available for an additional fee

Available in 7" and 9" strokes:

Model	Extended Length	Collapsed Length
S7Z	20.00"	13.14"
S9Z	23.44"	14.94"

Available in these standard valvings: (Example: S7Z-3030 or S9Z-3030)

1090	3040	3540	4555	5570	6065	8040
2020	3050	4010	5030	6010	7030	8060
2040	3060	4020	5050	6040	7045	
3030	3530	4040	5555	6060	7060	

Digressive Short Track Shock Numbering System

EXAMPLE: S 7 Z 60 60

BODY SERIES:

S Steel body grooved for snap rings to seat coilover kit.

A Aluminum body threaded for spring seat nut.

Stroke in inches (Compressed length subtracted from the extended length.)

Z 46mm Dia. (1.81") Digressive Valving
G 36mm Dia. (1.42") Digressive Valving

Rebound damping

Compression damping

REBOUND
COMPRESSION

IMPORTANT: Rebound and Compression are expressed in the industry standard, 4, 5, 6 etc. with a second digit to allow for a degree of dampening between whole numbers. For example: 50 means 5, 55 means 5 1/2.





SL Series

Designed for, but is not limited to, Modifieds, and Late Models.

46mm (1.81") diameter steel, sealed monotube gas pressure shock.

- Linear style valving
- Converts to coilover applications
- Plated for durability and rapid heat dissipation
- Bilstein's famous consistent, fade-free performance

Available in 5", 6", 7", 8" and 9" strokes:

Stroke	Part No.	Extended Length	Collapsed Length
5"	B46-0201	16.25"	11.25"
6"	B46-0202	18.25"	12.00"
7"	B46-0210	20.00"	13.14"
8"	B46-0203	22.25"	14.00"
9"	B46-0207	23.44"	14.94"

Available in these standard valvings: (Example: B46-0201H or B46-0203A)

A= 230/78	D= 220/120	H= 300/100	S= 230/100
B= 208/72	E= 270/90	L= 180/95	U= 200/180
C= 162/55	F= 175/60	R= 180/120	

Linear Short Track Shock Numbering System

EXAMPLE: B 46 - 0210 300/100

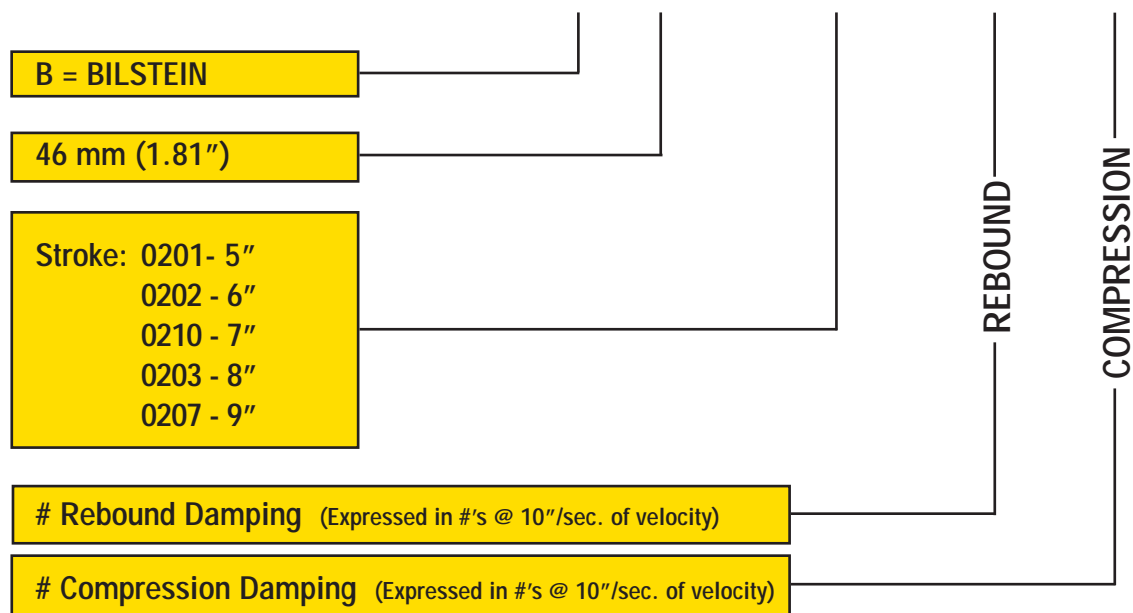

SLS Series

Designed for, but is not limited to, Stock Car/Hobby Stock, Modifieds, and Late Models.

46mm (1.81") diameter steel, sealed monotube gas pressure shock.

- Linear style valving
- Converts to coilover applications
- Plated for durability and rapid heat dissipation
- Bilstein's famous consistent, fade-free performance

Available in 7" and 9" strokes:

Stroke	Extended Length	Collapsed Length
7"	20.00"	13.14"
9"	23.44"	14.94"

Linear cross-reference list:

F4-BE5-F590-M0	S7L-2.5-2.5S (150/150)	F4-BE5-F603-M0	S9L-1.5-5S (100/275)
F4-BE5-F591-M0	S7L-3-4S (175/225)	F4-BE5-F604-M0	S9L-2-2S (125/125)
F4-BE5-F592-M0	S7L-3-5S (175/275)	F4-BE5-F605-M0	S9L-2.5-2.5S (150/150)
F4-BE5-F593-M0	S7L-3.5-1S (200/75)	F4-BE5-F606-M0	S9L-3-3S (175/175)
F4-BE5-F594-M0	S7L-3.5-1.5S (200/100)	F4-BE5-F607-M0	S9L-3-4S (175/225)
F4-BE5-F595-M0	S7L-4-2S (225/125)	F4-BE5-F608-M0	S9L-3-5S (175/275)
F4-BE5-F596-M0	S7L-4-4S (225/225)	F4-BE5-F609-M0	S9L-3-6S (175/325)
F4-BE5-F597-M0	S7L-5-1.5S (275/100)	F4-BE5-F610-M0	S9L-3.5-1S (200/75)
F4-BE5-F598-M0	S7L-5-5S (275/275)	F4-BE5-F611-M0	S9L-3.5-3.5S (200/200)
F4-BE5-F599-M0	S7L-6-2S (325/125)	F4-BE5-F612-M0	S9L-4-1.5S (225/100)
F4-BE5-F600-M0	S9L-1.5-1.5S (100/100)	F4-BE5-F613-M0	S9L-4-4S (225/225)
F4-BE5-F601-M0	S9L-1.5-2.5S (100/150)	F4-BE5-F614-M0	S9L-5-1.5S (275/100)
F4-BE5-F602-M0	S9L-1.5-3.5S (150/150)	F4-BE5-F615-M0	S9L-5-5S (275/275)

4-Bar Dirt Modified Race Shock Kit Package

Perfect for dialing in your car. Everything is included...the shocks, instructions and recommended set-ups.

Kit includes 10 SLS Series shocks:

Dirt Modified Race Shock Kit #F4-SE7-G696-M0

SLS Series Numbering System

EXAMPLE: S 7 L - 3 - 4 S

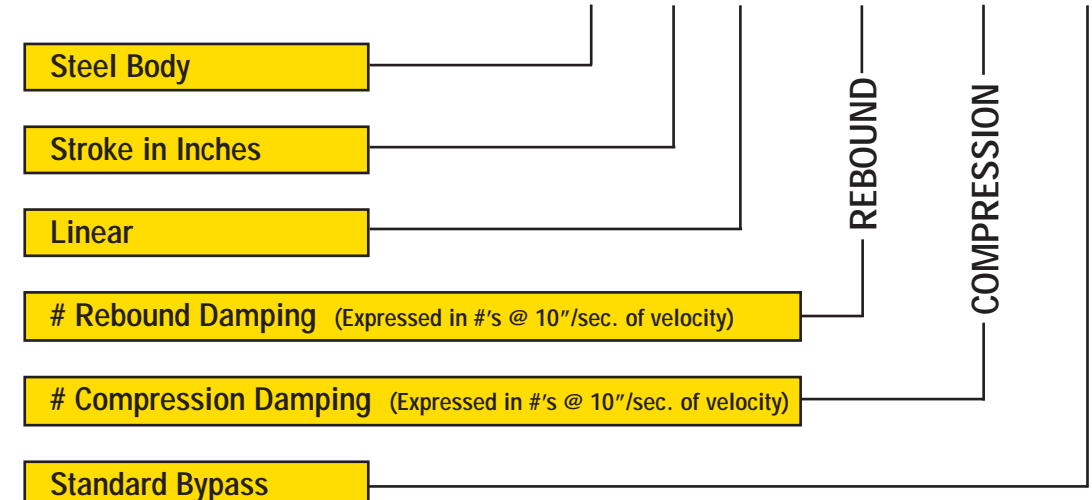



SN / SNS Series



ASB Series



Designed for, but is not limited to, Modifieds, Late Models and Sprint Cars.
46mm (1.81") diameter steel body, aluminum billet cap (SN) or steel cap (SNS) with schrader valve. Sold in kit form, less valve plates, oil and nitrogen gas charge.

- SN – aluminum billet cap
- SNS – steel cap
- Rebuildable; shock can be assembled and disassembled for rapid repair or valving change
- Nickel plated for rapid heat dissipation
- Valve stacks and valving kits available separately
- Available with linear or digressive piston
- Every part of the SN shock is available separately for economical repair
- World class performance at a SN (Saturday Night) price
- Bilstein's famous consistent, fade-free performance

SN Series:

Part No.	Description	Extended Length	Collapsed Length
B46-LTA5/DTA5	5" - stroke	16.32"	11.48"
B46-LTA6/DTA6	6" - stroke	18.13"	12.42"
B46-LTA7/DTA7	7" - stroke	20.08"	13.50"
B46-LTA8/DTA8	8" - stroke	22.07"	14.47"
B46-LTA9/DTA9	9" - stroke	23.44"	15.16"

SNS Series:

Part No.	Description	Extended Length	Collapsed Length
B46-LTA5S/DTA5S	5" - stroke	16.32"	11.48"
B46-LTA6S/DTA6S	6" - stroke	18.13"	12.42"
B46-LTA7S/DTA7S	7" - stroke	20.08"	13.50"
B46-LTA8S/DTA8S	8" - stroke	22.07"	14.47"
B46-LTA9S/DTA9S	9" - stroke	23.44"	15.16"

LTA = Linear
DTA = Digressive

Optional slide-on coilover kit hardware and gas fill tool are sold separately.



Part No. B4-BOA-0000117



Part No. 193000

Designed for, but is not limited to, Sprint Cars, Midgets, Mini-Sprints, TQ Midgets, Micro-Midgets and Formula Cars.

Ultra lightweight 36mm aluminum threaded body provides faster heat dissipation.

- Famous Bilstein consistency and absolute fade-free performance
- Racer rebuildable, revalvable, repairable and features adjustable rod pressure to suit any condition
- Schrader valve counter sunk out of harms way
- Available in 6", 7" and 8" strokes
- Can be built with linear, standard digressive or "compression only bypass" digressive pistons
- Optional composite wear sleeve available to protect shock tube

Part No.	Description	Extended Length	Collapsed Length
B36-ATAL6/ATAD6	5.00" - stroke	17.32"	11.44"
B36-ATAL7/ATAD7	7.00" - stroke	20.08"	12.81"
B36-ATAL8/ATAD8	8.00" - stroke	22.46"	14.06"

Optional coilover mounting kit hardware, gas fill tool and rod guide spanner are sold separately.



Part No. B4-BOA-0000257



Part No. B4-BOA-0000259



Part No. E4-XS1-Z002A00



ASN Series



Designed for, but is not limited to, Modifieds, Late Models and Sprint Cars.

46mm (1.81") diameter threaded aluminum body with schrader valve and circlip rod guide.

- Rebuildable; shock can be assembled and disassembled for rapid repair or valving change
- Hard anodized for durability
- Valve stacks and valving kits available separately
- Available with linear or digressive piston
- Every part of the ASN shock is available separately for economical repair
- World class performance in an aluminum shock at an economy price
- Bilstein's famous consistent, fade-free performance
- Optional adjustable shaft/compression canister
- Optional composite wear sleeve available to protect shock tube

Part No.	Description	Extended Length	Collapsed Length
B46-ATAL4/ATAD4	4.00" - stroke	14.21"	10.45"
B46-ATAL5/ATAD5	5.00" - stroke	16.25"	11.25"
B46-ATAL6/ATAD6	6.00" - stroke	18.37"	12.66"
B46-ATAL7/ATAD7	7.00" - stroke	20.23"	13.35"
B46-ATAL8/ATAD8	8.00" - stroke	22.26"	14.70"
B46-ATAL9/ATAD9	9.00" - stroke	23.60"	15.08"

7ATAL = Linear
ATAD = Digressive



Part No. B4-BOA-0000190

Optional coilover mounting kit hardware and gas fill tool are sold separately.



Part No. 193000



BGT Series



Designed for, but is not limited to, Late Models, Super Late Models, Sprint Cars, Dirt Late Models and Big Block Modifieds.

46mm aluminum body with extra large 60mm nitrogen compartment.

- Coilover design
- Available with or without base valve
- 14mm piston shaft
- 60mm nitrogen compartment reduces rod pressure and keeps pressure more consistent to heat changes
- Bilstein's famous consistent, fade-free performance
- Racer rebuildable and revalvable
- Hard coat anodizing for strength and durability
- Coarse threads on shock body for added strength and ease of coil spring adjustment
- Optional composite wear sleeve available to protect shock tube
- Optional adjustable shaft
- Available in 7" and 9" strokes

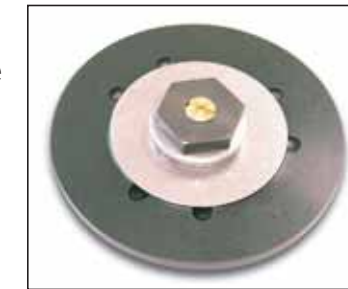

Available BGT Base Valve

Part No.	Description	Extended Length	Collapsed Length
B46-60BG7C	7.00" - stroke	21.75"	14.75"
B46-60BG9C	9.00" - stroke	25.25"	16.75"



Part No. B4-BOA-0000190



Part No. 193000

Optional coilover mounting kit hardware and gas fill tool are sold separately.



Big Track Series



Optional Shock Components



B46-GN3

B46-60BG8

Rebuildable Shocks for NASCAR Classes

B46-60BG8

- Aluminum construction
- 60mm gas chamber
- Increased oil volume
- Base valve option
- Linear, digressive and RBT piston available
- Adjustable shaft option
- Screw in rod guide

B46-GN3

- Aluminum construction
- 46mm body
- Linear, digressive and RBT piston available
- Adjustable shaft option
- Screw in rod guide

Part No.	Extended Length	Collapsed Length
B46-60BG8	22.60"	15.67"
B46-GN3	24.40"	16.60"



Adjustable Shaft:

- Excellent for dirt racing
- 6 position adjustment knob
- Broad adjustment for each position
- Can be added or retrofitted to any SN or ASN shock
- Can be used as open jet
- Can be used with rebound check valve
- Can be used with compression check valve

Double Adjustable Shaft:

- Excellent for pavement and dirt racing
 - 10 position rebound knob
 - 10 position compression knob
- Uniformed adjustment with rebound and compression tuned independently
- Shaft utilizes new 1 to 1 billet linear piston



Compression Canister:

- Excellent for both dirt and pavement
- Knurled aluminum body
- 10 position adjuster
- Hand operated adjuster – no tools required
- Adds compression with each position
- Base valve allows for lower rod pressure
- Can be added or retrofitted to any SN or ASN shock



Dwarf & Mod Lites



Mini Sprints (600cc to 750cc)

RECOMMENDED SET-UPS

Basic Set-Up – Asphalt			
PART NO.	S6G-3535	L.F.	R.F. S6G-4545
PART NO.	S6G-3030	L.R.	R.R. S6G-3030

Basic Set-Up – Heavy, Hooked Up Surface			
PART NO.	S6G-3535	L.F.	R.F. S6G-4545
PART NO.	S6G-3535	L.R.	R.R. S6G-4545

Basic Set-Up (Slick Surface)			
PART NO.	S6G-3030	L.F.	R.F. S6G-2040
PART NO.	S6G-3010	L.R.	R.R. S6G-3010

NOTE: All of the above valving recommendations utilize our S6G Series Mini Racing shock. Consult page 10 for the extended length and collapsed length for this product. If your car requires a longer shock, consider using the S7G Series shock also featured on page 10. Also consider moving the upper shock mounts up or down to accommodate either the S6G or S7G Series Mini Racing Shock.

RECOMMENDED SET-UPS

Basic Set-Up – Dirt			
PART NO.	S6G-3030	L.F.	R.F. S6G-2040
PART NO.	S6G-4020	L.R.	R.R. S6G-4020

Basic Set-Up – Asphalt			
PART NO.	S6G-4020	L.F.	R.F. S6G-3535
PART NO.	S6G-4020	L.R.	R.R. S6G-3535

Basic Set-Up – Dirt			
PART NO.	S6G-3010	L.F.	R.F. S6G-1030
PART NO.	S6G-3010	L.R.	R.R. S6G-3010

Basic Set-Up – Asphalt			
PART NO.	S6G-3535	L.F.	R.F. S6G-3535
PART NO.	S6G-6020	L.R.	R.R. S6G-4545

NOTE: All of the above valving recommendations utilize our S6G Series Mini Racing shock. Consult page 10 for the extended length and collapsed length for this product. If your car requires a longer shock, consider using the S7G Series shock also featured on page 10. Also consider moving the upper shock mounts up or down to accommodate either the S6G or S7G Series Mini Racing Shock.



Midgets

(Chassis: Doemelt, Baily, Beast, Ellis, etc.)



Sprint Cars

RECOMMENDED SET-UPS

Basic Set-Up (Dirt and Asphalt)			
PART NO.	S6G-3535 or S7G-3535	L.F. R.F.	S6G-3535 or S7G-3535
PART NO.	S7G-3535	L.R. R.R.	S7G-3535

Suggested For "Dry, Slick" Conditions (Dirt)			
PART NO.	S6G-3030 or S7G-3030	L.F. R.F.	S6G-2040 or S7G-2040
PART NO.	S7G-4020	L.R. R.R.	S7G-4020

Suggested For "Heavy, Tacky" Conditions (Dirt)			
PART NO.	S6G-3535 or S7G-3535	L.F. R.F.	S6G-3535 or S7G-3535
PART NO.	S7G-5030	L.R. R.R.	S7G-4545

Fast, High Bank Asphalt			
PART NO.	S6G-3535 or S7G-3535	L.F. R.F.	S6G-4545 or S7G-3535
PART NO.	S7G-3535	L.R. R.R.	S7G-4545

NOTE: All of the above valving recommendations utilize our S6G Series Mini Racing Shocks on the front and S7G Series Mini Racing Shocks on the rear. Consult page 10 for the extended lengths and collapsed lengths for these products. If your car will not accommodate shocks of these dimensions, consider moving your upper shock mount up or down to the desired static center to center dimension.

RECOMMENDED SET-UPS

With Wing - Basic Set-Up (Dirt)			
PART NO.	S7G-3535	L.F. R.F.	S7G-3050
PART NO. W/Valve Stack	S8G-5050	L.R. R.R.	S8G-5050

With Wing - Dry, Slick Track (Dirt)			
PART NO.	S7G-3050	L.F. R.F.	S7G-3050
PART NO. W/Valve Stack	S8G-4040	L.R. R.R.	S8G-4040

With Wing - Heavy, Tacky Track (Dirt)			
PART NO.	S7G-5555	L.F. R.F.	S7G-4545
PART NO. W/Valve Stack	S8G-7035	L.R. R.R.	S8G-5555

With or Without Wing 1/4 To 3/8 Mi. Average Bank (Asphalt)			
PART NO. W/Valve Stack	S7G-5555	L.F. R.F.	S7G-5555
PART NO. W/Valve Stack	S8G-5050	L.R. R.R.	S8G-5050

With or Without Wing 3/8 to 1/2 Mi. Fast, High Bank (Asphalt)			
PART NO. W/Valve Stack	S7G-5555	L.F. R.F.	S7G-5555
PART NO. W/Valve Stack	S8G-5555	L.R. R.R.	S8G-5555

NOTE: It is assumed on this set-up sheet that the car utilizes 7" stroke shocks in front, and 8" stroke shock in the rear. Before purchase, measure shock mounts center to center at static ride height. Check the extended and collapsed measurements on catalog page 10 to determine if your car needs S6G, S7G, or S8G series shocks. (S8G's normally replace competitor's 9" stroke shocks.)



I.M.C.A. Style Stock Car



I.M.C.A. Type Modified Dirt

RECOMMENDED SET-UPS

Base Line Set-Up			
PART NO.	S7Z-4040 or S7L-4-4S	L.F.	R.F. S7Z-4555 or S7L-5-5S
PART NO.	S9Z-4040 or S9L-4-4S	L.R.	R.R. S9Z-3030 or S9L-3-3S

Dry Slick Track Conditions			
PART NO.	S7Z-4040 or S7L-4-4S	L.F.	R.F. S7Z-4545 or S7L-6-2S
PART NO.	S9Z-5030 or S9L-6-2S	L.R.	R.R. S9Z-5030 or S9L-6-2S

Stock Mount Stock Car / I.M.C.A. Hobby Stock Class

RECOMMENDED SET-UPS

Base Line Set-Up			
PART NO.	AK1043 or AK4040F	L.F.	R.F. AK5555F
PART NO.	AK1044 or AK5030R	L.R.	R.R. AK1044

Slick Track Option			
PART NO.	AK4040F	L.F.	R.F. AK3060F
PART NO.	AK6010COBR	L.R.	R.R. AK5030R or AK3030R

RECOMMENDED SET-UPS

Base Line 2-Link Set-Up			
PART NO.	S7G-3535 or S7Z-4040 or S7L-3-4S	L.F.	R.F. S7G-4545 or S7Z-4040 or S7L-4-4S
PART NO.	S9Z-3030 or S9L-3-3S	L.R.	R.R. S9Z-3030 or S9L-3-3S

Base Line Set-Up for 4-Bar			
PART NO.	S7G-3535 or S7Z-4040 or S7L-4-4S	L.F.	R.F. S7G-4545 or S7Z-4040 or S7L-4-4S
PART NO.	S9Z-3050 or S9L-3-6S	L.R.	R.R. S9Z-3030 or S9L-3-3S

4-Bar Base Line Set-Up for Dry Slick Track Conditions			
PART NO.	S7G-3535 or S7Z-3545 or S7L-3-4S	L.F.	R.F. S7G-3050 or S7Z-5030 or S7L-6-2S
PART NO.	S9Z-3050 or S9L-3-6S	L.R.	R.R. S9Z-3030 or S9L-3-3S

4-Bar Base Line Set-Up for Heavy, Tacky Track Conditions			
PART NO.	S7G-4545 or S7Z-4040 or S7L-4-4S	L.F.	R.F. S7G-5555 or S7Z-5050 or S7L-5-5S
PART NO.	S9Z-3050 or S9L-3-4S	L.R.	R.R. S9Z-4040 or S9L-4-4S

DP 1 – Package is available for an additional cost. This is a custom valving package for dry slick track that produces more “feel”.



Dirt Modified (North East Modified)



Super Late Model Dirt

RECOMMENDED SET-UPS

NOTE: These recommended combinations can use Bilstein SZ, SL, SN, ASN or BGT Series "Take-Apart" shocks. A custom valve charge will be incurred when ordering sealed SZ or SL Series shocks not listed on pages 12 and 13 of this catalog.

Basic Set-Up				
PART NO. VALVING	B46-0210C 162/55	L.F.	R.F.	B46-0210C 162/55
PART NO. VALVING	B46-0207B 208/72	L.R.	R.R.	B46-0207B 208/72

Side Bite				
VALVING	162/55	L.F.	R.F.	162/55
VALVING	162/100* or LRTD	L.R.	R.R.	230/72 or RRMED**

Momentum Track				
VALVING	162/55	L.F.	R.F.	162/72 or 208-55
VALVING	208/90	L.R.	R.R.	208/90

Syracuse Set-Up				
VALVING	300/78*	L.F.	R.F.	270/78*
VALVING	270/78*	L.R.	R.R.	230/100*

* Custom valved shock
** Option

RECOMMENDED SET-UPS

NOTE: These recommended combinations can use Bilstein SZ, SL, SN, ASN or BGT Series "Take-Apart" shocks. A customer valve charge will be incurred when ordering sealed SZ or SL Series shocks not listed on pages 12 and 13 of this catalog.

Basic Digressive Set-Up – Four-Link				
VALVING	4040	L.F.	R.F.	5050
VALVING	3050	L.R.	R.R.	4040

Dry Slick Digressive Set-Up – Four-Link				
VALVING	3050	L.F.	R.F.	5030
VALVING	3050	L.R.	R.R.	3030

Basic Linear Set-Up – Four-Link				
VALVING	300/100	L.F.	R.F.	300/100
VALVING	2080*	L.R.	R.R.	208/72

Basic Set-Up – Swing Arm				
VALVING	6010	L.F.	R.F.	6010
VALVING	6010	L.R.	R.R.	6010

Consult Bilstein Service and Valving Manual for build schematics for these valve stacks

* Custom valved shock.

NOTE: All of the above set-ups assume your chassis uses 7" stroke shocks on the front, and 9" stroke shocks on the rear. When ordering from your Bilstein dealer be sure to ask for the appropriate stroke for each corner of your chassis.



I.M.C.A. Type Modified Asphalt



RECOMMENDED SET-UPS

NOTE: These recommended combinations can use Bilstein SZ, SL, SN, ASN or BGT Series "Take-Apart" shocks. A custom valve charge will be incurred when ordering sealed SZ or SL Series shocks not listed on pages 12 and 13 of this catalog.

1/4 Mi to 3/8 Mi Shallow Bank, Low Speed Corner Entry				
VALVING	270/90	L.F.	R.F.	270/90
VALVING	6010	L.R.	R.R.	5030

1/4 Mi to 3/8 Mi Banked, High Speed Corner Entry				
VALVING	270/90	L.F.	R.F.	180/120
VALVING	6010	L.R.	R.R.	6010

3/8 Mi to 1/2 Mi Shallow Banked, High Speed Corner Entry				
VALVING	270/90	L.F.	R.F.	180/120
VALVING	6010	L.R.	R.R.	5030

3/8 Mi to 1/2 Mi Banked, High Speed Corner Entry				
PART NO.	S7Z-6060	L.F.	R.F.	S7Z-6060
PART NO.	S9Z-5030	L.R.	R.R.	S9Z-5050

1/2 Mi High Banked, Very High Speed Corner Entry				
PART NO.	S7Z-6040	L.F.	R.F.	S7Z-6040
PART NO.	S9Z-6040	L.R.	R.R.	S9Z-6040

NOTE: All of the above set-ups assume your chassis uses 7" stroke shocks on the front, and 9" stroke shocks on the rear. When ordering from your Bilstein dealer be sure to ask for the appropriate stroke for each corner of your chassis.

Soft Spring / Big Bar				
VALVING	CALL TECH DEPT.	L.F.	R.F.	CALL TECH DEPT.
VALVING	CALL TECH DEPT.	L.R.	R.R.	CALL TECH DEPT.

Tech Department: 877-666-7662

Asphalt Modified (NASCAR Type)

RECOMMENDED SET-UPS

NOTE: These recommended combinations can use Bilstein SZ, SL, SN, ASN or BGT Series "Take-Apart" shocks. A custom valve charge will be incurred when ordering sealed SZ or SL Series shocks not listed on pages 12 and 13 of this catalog.

Standard Basic Set-Up #1				
PART NO. VALVING	B46-0201E 270/90	L.F.	R.F.	B46-0201E 270/90
PART NO. VALVING	B46-0210 208/90	L.R.	R.R.	B46-0210 208/90

Standard Basic Set-Up #2				
VALVING	325/90	L.F.	R.F.	220/120
VALVING	6010	L.R.	R.R.	5030

NOTE: Set-Up #1 – Forward Drive not an Issue.
Set-Up #2 – Forward Drive IS an Issue.

All of the above set-ups assume your chassis uses 5" stroke shocks on the front, and 8" stroke shocks on the rear. When ordering from your Bilstein dealer be sure to ask for the appropriate stroke for each corner of your chassis.

Soft Spring / Big Bar				
VALVING	CALL TECH DEPT.	L.F.	R.F.	CALL TECH DEPT.
VALVING	CALL TECH DEPT.	L.R.	R.R.	CALL TECH DEPT.

Tech Department: 877-666-7662



Late Model Stock / Super Late Model Asphalt

3100 lb. (350 cfm Carb) – NASCAR Type

RECOMMENDED SET-UPS

NOTE: These recommended combinations can use Bilstein SZ, SL, SN, ASN or BGT Series "Take-Apart" shocks. A custom valve charge will be incurred when ordering sealed SZ or SL Series shocks not listed on pages 12 and 13 of this catalog.

Conventional				
VALVING	300/100	L.F.	R.F.	300/100
VALVING	6010	L.R.	R.R.	5030

Banked track				
VALVING	270/90	L.F.	R.F.	220/120
VALVING	5030	L.R.	R.R.	5050

NOTE: Set-ups above indicate recommended valvings only. Choose desired late model stock car shock from products described on pages 10, 11, 17 or 18 of this catalog. Set-up recommendations are meant to provide base line numbers only for the chassis tuning process described on page 31.

Soft Spring / Big Bar				
VALVING	CALL TECH DEPT.	L.F.	R.F.	CALL TECH DEPT.
VALVING	CALL TECH DEPT.	L.R.	R.R.	CALL TECH DEPT.

Tech Department: 877-666-7662



How to Shock Tune Your Chassis



Study the current Bilstein set-up recommendations for your particular type of racing. These combinations are tested and proven successful, but due to the many variables that come into play under racing conditions, it is to your advantage to have a basic understanding of how shock damping rates affect your lap times. Adjustments can then be made with reason and understanding. Simply stated, shock absorbers convert the kinetic energy of the spring movements into heat. This heat is then dissipated into the air through the shock tube or body. In practical application, shock absorbers are necessary to maintain maximum tire patch contact to the track as the car corners and negotiates irregularities on the race track surface.

Spring rates determine how far your chassis rolls, pitches or squats. Shock rates determine the length of time it takes for each of these movements to occur.

Rebound damping controls the movement of that part of the car's sprung mass that is stored in a compressed spring. The rebound damping rate determines how long it takes for the compressed spring to return to the static ride height. The larger the rebound figure, the more the shock resists the compressed spring's effort to rebound, and the longer it takes for the chassis to return to the static ride height.

Compression damping controls only the oscillation of the car's unsprung weight. Therefore, it is normal to use less compression damping than rebound damping. The exception occurs when we choose to slow the downward movement on a

particular corner of the car to mimic the effect of a stiffer spring.

Here are some guide lines to use when shock tuning your chassis at the track or making the best decisions during initial set-up. We are making the assumption that you have removed as many variables as possible and are using the best combination of springs, weight, wheel spacers, tire compound, stagger, etc.

Utilizing the "Think Track" below, study the following list of suggestions. These are not rules, not even rules of thumb, but they are tendencies that are more often true than not when racing late models and modifieds on asphalt or dirt surfaces.

THINK TRACK

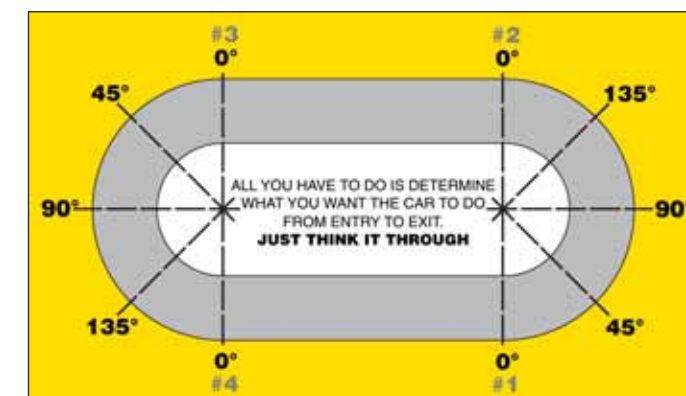

Trouble Shooting the Car at the Track

If your car is:

Loose (Oversteer) from 0° to 90°

- Increase compression rate on front.
- Decrease rebound rate on rear, or only on left rear.

Tight (Understeer) from 0° to 90°

- Decrease compression rate on front, or only on right front.
- Increase rebound rate on rear, or only on left rear.

When analyzing corner entry, or deceleration handling, realize that the chassis is affected by:

**Compression rate in front.
Rebound rate at rear.**

Loose (Oversteer) from 90° to 0°

- Decrease rebound rate on front.
- Decrease compression rate on rear.

Tight (Understeer) from 90° to 0°

- Increase rebound rate on front.
- Increase compression rate on rear, or only on right rear.

When analyzing corner exit, or acceleration handling, realize that the chassis is affected by:

**Rebound rate in front.
Compression rate at rear.**

Bilstein shocks are famous for their superior performance on very rough asphalt or rutted dirt tracks. You may need to choose a shock with more compression damping than found on our set-up sheets under extreme rough track conditions.

We have included this section in our catalog to broaden your understanding of the function of shock absorbers and to show you the effect they have on handling.

Keep in mind that there are many adjustments on your chassis other than shock absorbers. The oversteer/understeer balance may be affected by stagger, tire compound, wheel spacing, spring rates, sway bar, panhard and others. Shocks can be used to fine tune your chassis to gain that last few tenths of a second on the track.

If you have any questions, contact our technical department at 877-666-7662.