

# Introduction

## THE NAVIGATION SYSTEM

The Jaguar navigation system assists the driver by providing a route to a selected destination. Guidance is given by means of audible instructions (voice guidance), complemented by map and turn information, which is displayed on the touch-screen. Digital map information is held on the Navigation System Digital Versatile Disc (DVD).



### WARNING:

**In the interests of road safety, only operate, adjust or view the system when it is safe to do so.**

The system has a comprehensive range of features, yet is easy to use. Some time spent reading this handbook will ensure that the best results are obtained.

The touch-screen is used to control the system by means of menus, text screens and map displays.

### Loading the navigation DVD

**Note:** Before using the navigation system, ensure that the DVD that contains the correct country mapping information is loaded in the navigation control unit housed in the luggage compartment.

**Note:** The ignition system must be on. The luggage separator in the coupe must be removed.

In the luggage compartment, prise out the lug on the left side of the access cover then pull the cover to the left to release the retaining lugs.

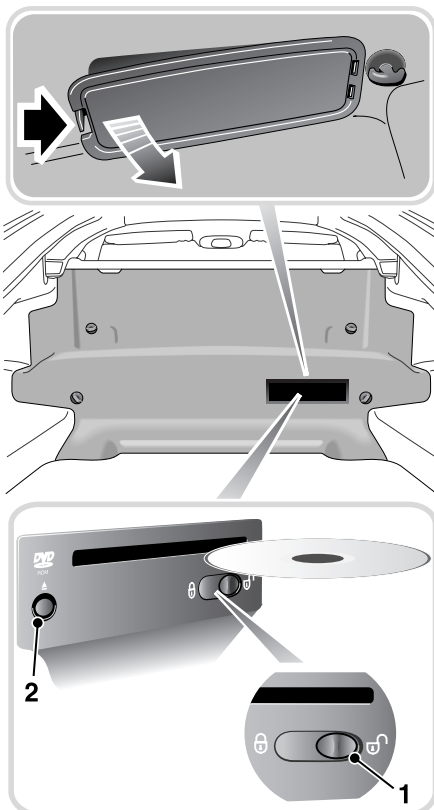

JOL4505G

Move the lock/unlock button to the unlock position (1).

Press the unload button (2) to eject a DVD, if one is installed in the DVD player.

Load the correct Navigation System DVD with the printed side upwards. Do not allow moisture or foreign objects to enter the slot.

Move the lock/unlock button to the locked position. Replace the access cover.

# How the System Works

---

## SATELLITE SIGNALS

The system uses signals from the Global Positioning System (GPS) satellites, which allow the approximate position of the vehicle to be calculated. This is combined with information from vehicle sensors and data from the Navigation System Digital Versatile Disc (DVD) to establish the true vehicle position.

The navigation computer then integrates this data with the information stored on the DVD enabling you to plan and follow a route map to your desired destination. This is particularly useful if you are travelling to or through unfamiliar territory.

### Digitised area

The navigation system can only provide information and guidance for the area covered by the navigation DVD - ensure that you are using the latest version of the correct DVD for your country.

**Note:** *Your Jaguar Dealer will have details of how to order DVD updates.*

The navigation DVD provided, contains a digitised street map. Freeways, main and regional roads, as well as district roads are detailed in this street map. Larger cities and boroughs are completely covered. The regional and unclassified roads or access roads and the town centre for smaller towns and boroughs are included.

One way streets, pedestrian zones, turn bans and other traffic regulations are taken into account as far as possible. There may be discrepancies between the data on the navigation DVD and the actual local situation, due to temporary or permanent changes to road systems and their traffic regulations.

If the vehicle battery has been disconnected, or if the vehicle has been transported to a new location on another vehicle (e.g. by trailer or train), the navigation system may require several minutes to identify the new position.

### Errors in vehicle position

Under certain driving conditions, it is possible that the vehicle position shown may be incorrect. Some examples are shown below:

- Driving up or down circular ramps in car parks.
- Elevated roads in proximity to other roads.
- Where there are two roads parallel to each other.
- Driving on steep roads.
- When the vehicle is transported by ferry or train.
- After the tyres have been replaced.
- When using snow chains.
- After the vehicle has been rotated on a turntable.
- After vehicle battery removal or supply fuse failure.

# How the System Works

## Reception of GPS signals

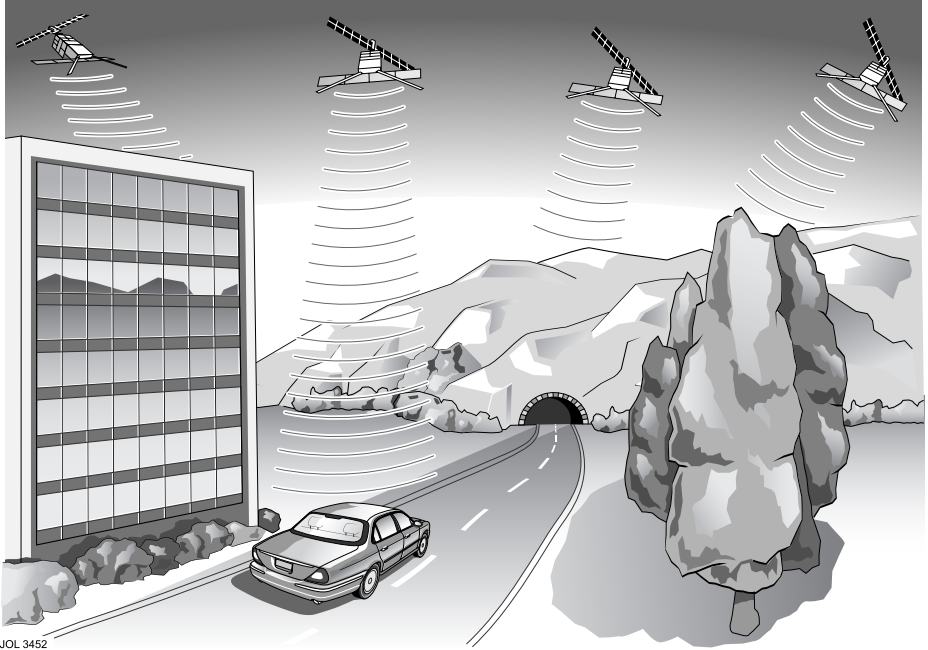

JOL 3452

GPS signals are highly directional and reception may occasionally be interrupted. Some examples of situations likely to cause problems are shown below:

- Inside tunnels
- Inside buildings
- Roads under raised highways
- Densely tree-lined roads
- Forest roads between mountains
- Between tall buildings
- Roads under cliffs.

However, the vehicle's direction and speed sensors will minimise any adverse effect on the operation of the navigation system, if this should occur. Normal operation will resume once the obstruction has been passed.

# Navigation Menu

## MAIN MENU

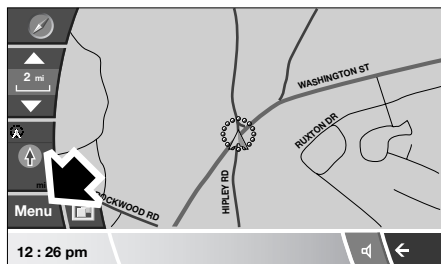

**Note:** To view the map without the buttons showing, touch anywhere on the map display. To display the buttons, touch **Menu**.

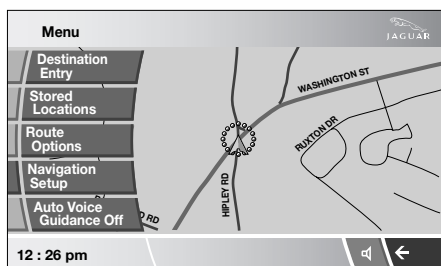

JOL4506NAS

After selecting navigation, the main menu is displayed showing the functions that are available. For detailed information on these items see:

**DESTINATION ENTRY**, page 30.

**STORED LOCATIONS**, page 26.

**ROUTE OPTIONS**, page 37.

**NAVIGATION SETUP**, page 21.

**AUTO VOICE GUIDANCE OFF**, page 15.

There are additional sections in this handbook specifically showing the compass display, Points of Interest (POI's) and End User Licence Agreements.

Select the menu item required.

# Navigation Setup

## SETTING THE NAVIGATION SYSTEM

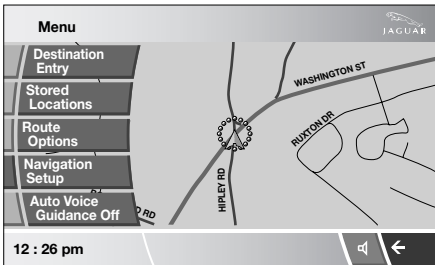
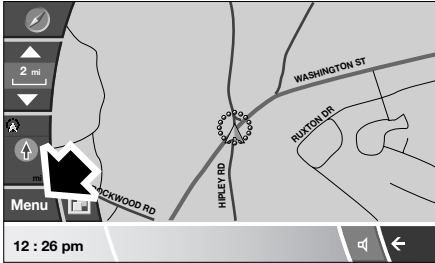

JOL4506NAS

From the main navigation menu select **Navigation Setup**.

## USER SETTINGS

A number of user settings can be made from this menu.

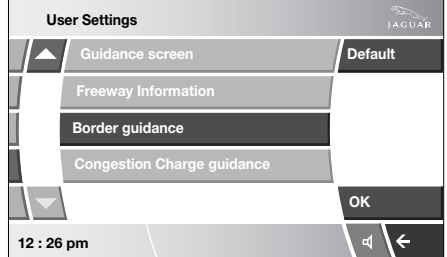
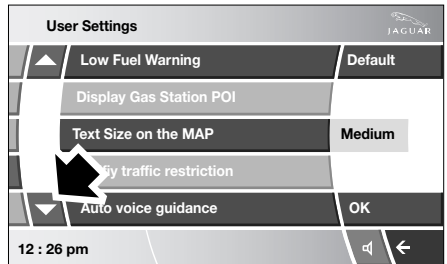
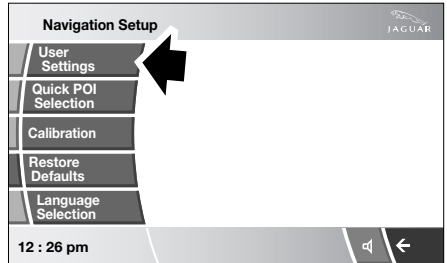

JOL4547NAS

Select those which you require then touch **OK**.

**Note:** Touch a dark blue band to select that feature or a light band to deselect it.

The individual details must be firstly set in the navigation setup menu.

# Navigation Setup

## Saving user preferences to memory

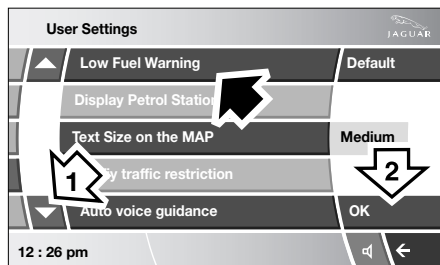
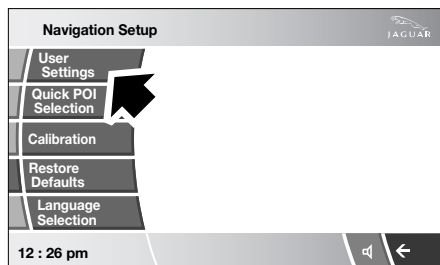
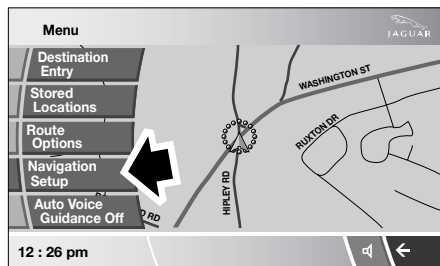

JOL4507NAS

Use the scroll arrows (1) to see the options. Most of these selections are either on or off, light blue line is not selected, dark is selected.

Touch the line of your choice then **OK** (2).

## QUICK POI SELECTION

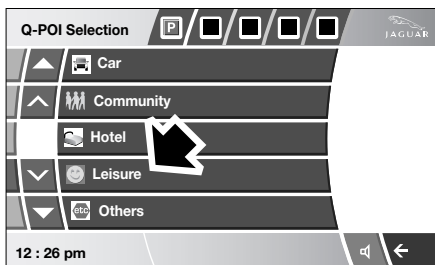
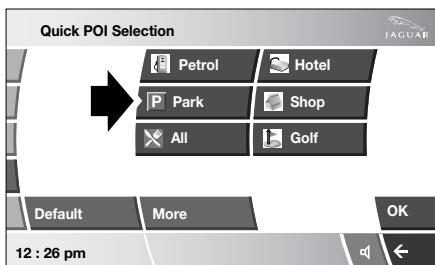
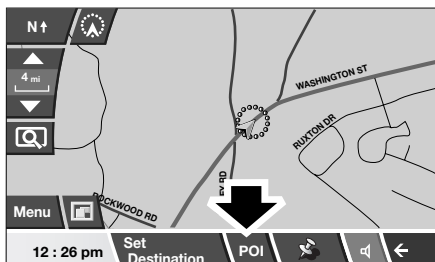

JOL4508NAS

Touch the Map screen, to display the POI button. Touch the POI button. The screen shows the six categories currently selected for quick points of interest.

**Note:** The POI button will not be active if the zoom level is above 1 km (1/2 mile).

Select a Quick POI category, or select **More** to see further POI's.

# Navigation Setup

The map screen with the POI icon(s) is displayed. Select those six POI's you wish to see when the Quick POI's are displayed.

## CALIBRATION

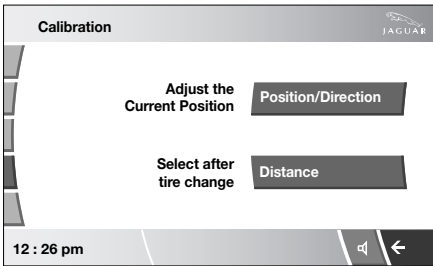
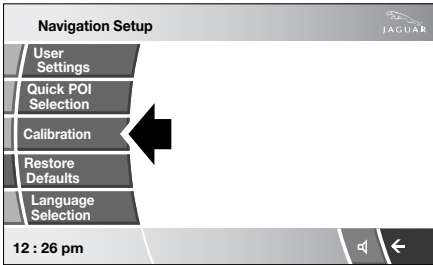

JOL4548NAS

If the vehicle has been moved, for example, by rail or trailer, the vehicle position/direction may need to be calibrated.

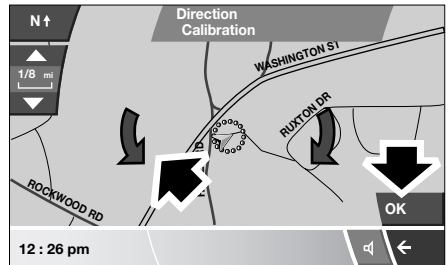
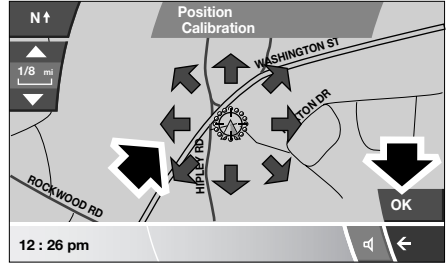

JOL4509NAS

The map showing the heading adjustment arrows is displayed. Adjust the heading by touching and using the arrows until the navigation symbol shows the correct alignment. Touch **OK** to confirm the new heading.

# Navigation Setup

## RESTORE SYSTEM DEFAULTS

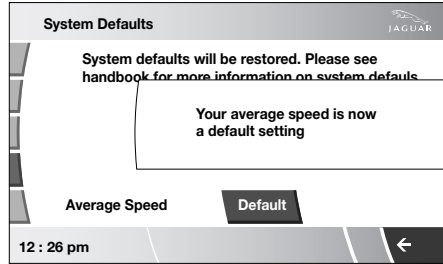
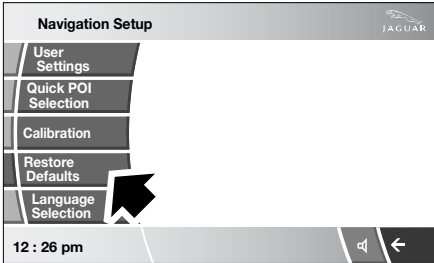

JOL4550NAS

If you have made any changes to the system default settings, speed settings etc. then using this menu will restore the original settings.

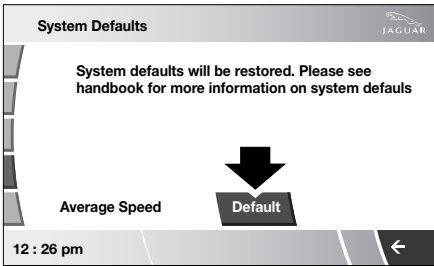

JOL4656NAS

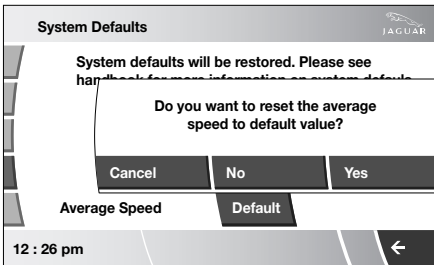

JOL4549NAS



# Navigation Setup

## LANGUAGE SELECTION

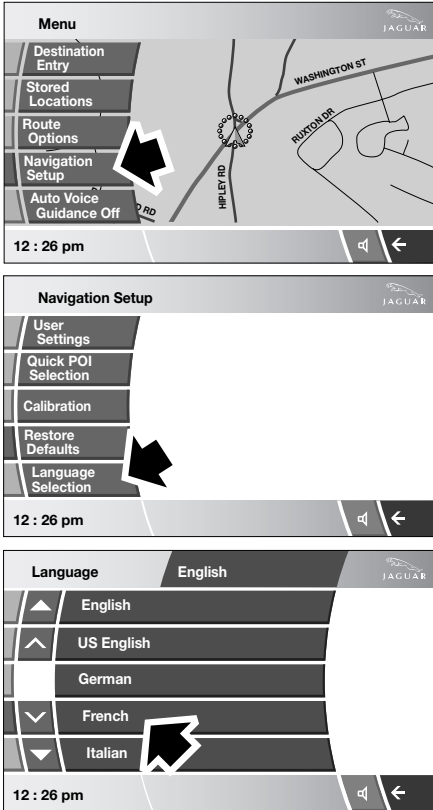

JOL4510NAS

Language change can be made from the map screen, see page 8, or as shown above using the Navigation Setup menu.

# Stored Locations

## INTRODUCTION

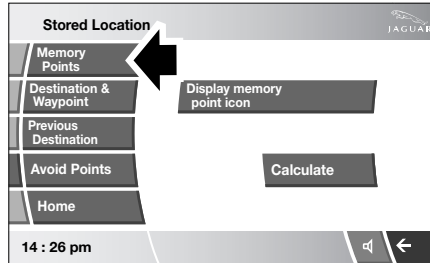
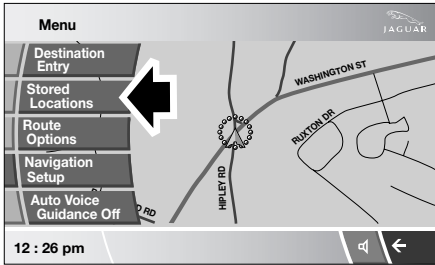

## MEMORY

From the navigation menu touch **Stored Locations**. This enables you to manage destinations such as, place of work, home, favourite restaurant or areas to avoid.

From **Stored Locations** menu you can save up to 106 memory points, add your home address and save up to 10 areas to avoid.

For this example we will store the exit at the freeway 270 and on to Aughwick Road.

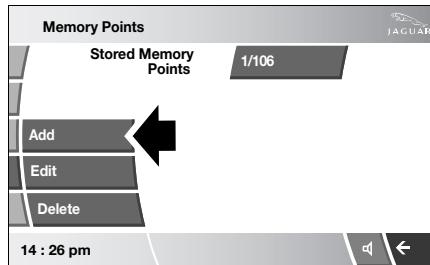

Select **Memory** to add a memory point (stored location).

Touching any of the **Stored Locations** submenus, shown in the top illustration above, allows you to **Add, Edit or Delete**.

**Note:** The screen above appears in many of the navigation submenu selections.

Select **Add** to select and store a memory point.

# Stored Locations

## To store a memory point

For this example we will choose a freeway exit.

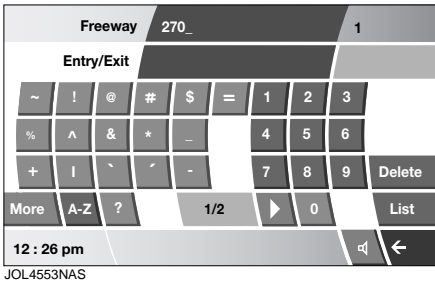
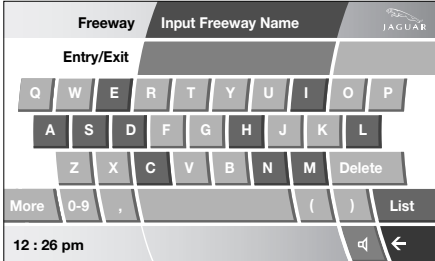

We will choose a freeway exit on the 270. Touch the numeric key (0 - 9) to change the keypad from alpha to numeric.

Enter **270**.

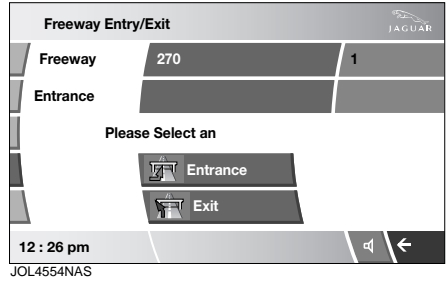

Choose **Exit**.

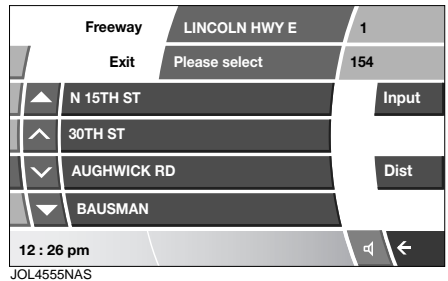

Select an exit, for this example choose Aughwick Road.

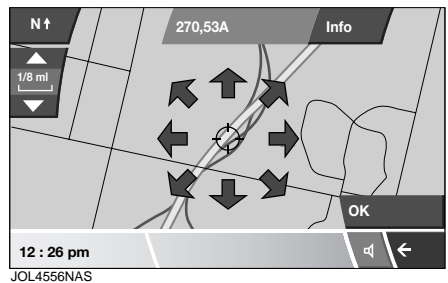

The map shows the 270 and the selected exit. Touch **OK**.

# Stored Locations



JOL4557NAS

Select Aughwick Road.

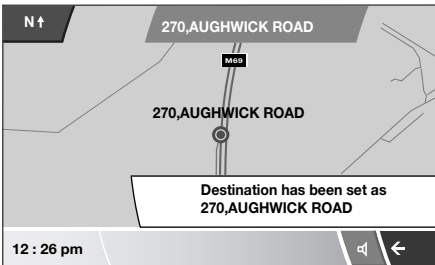

JOL4558NAS

For **Destination/Waypoint** entry, see **SETTING A DESTINATION** on page 10. This enables you to set waypoints or a destination.

## DESTINATION/WAYPOINT

Using Destination & lets you store a destination or any number of waypoints to your destination. Follow the Quick Start guide for setting a destination and adding waypoints.

**Note:** A Destination must be set before any Waypoints can be set.

## PREVIOUS

Previous cannot be used until memory points have been set. They can then be recalled. See **MEMORY** on page 26.

## AVOID POINTS

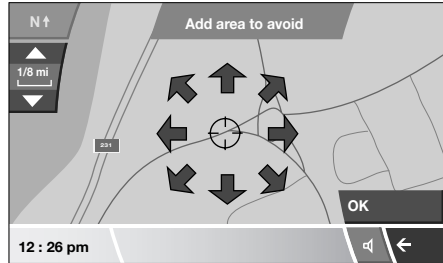

JOL4559NAS

After a route has been selected you can set a single or a series of **Avoid Points**. Touch **Avoid Points** and the map is displayed. Using your finger, touch the map and drag it until the circle is over the area you wish to avoid. Use the zoom bar if required to firstly enlarge the search area and, after moving the circle to the general area, zoom to precisely the area to avoid.

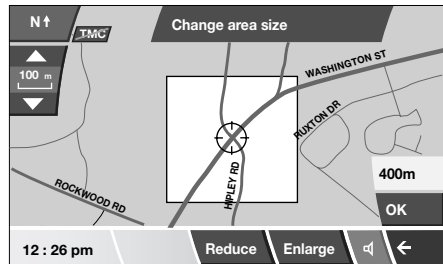

JOL4660NAS

Use the **Reduce/Enlarge** buttons to find the exact area you wish to avoid. Touch **OK**.

# Stored Locations

---

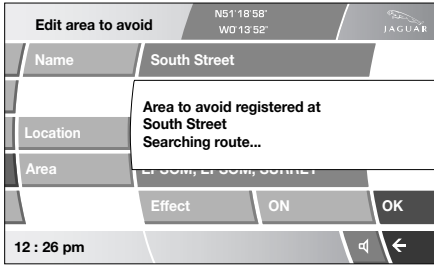

JOL4560NAS

The area to avoid is stored.

## HOME

From the **Stored Locations** menu select **HOME**.

# Destination Entry

## DESTINATION ENTRY

### Setting a destination

From the Navigation Menu, select **Destination Entry**.

The Destination Entry menu provides a choice of methods for entering a destination.

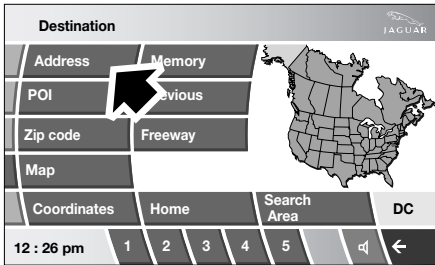

JOL4561NAS

To enter an address, see **SETTING A DESTINATION** in the Quick Start on page 10.

### Choosing your route

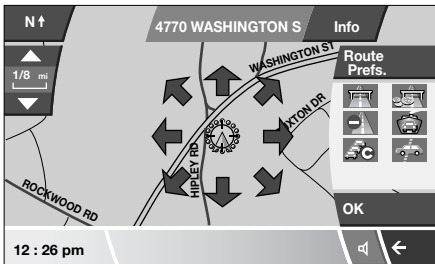

JOL4562NAS

Once the destination has been calculated options for your journey can be made by touching **Route Prefs.** or by selecting **3 Route** or **Change Route**.

To change your route preferences see page 37.

### Start guidance

When the system has calculated the route, the map is displayed.

The route will be highlighted on the map, with an icon showing your current position. The road name/number is also listed in the text area.

If no destination is set, the **Destination** key is highlighted and **Waypoint** is greyed out (not selectable).

If a destination is set and no waypoint is set both **Destination** and **Waypoint** are highlighted.

If a destination and a waypoint are set, the **Destination** key is greyed out and the **Waypoint** key is highlighted for the addition, if required, of further waypoints.

Drive away, following the voice guidance given by the system. As you approach a junction, in addition to the voice guidance, an inset on the map will display an enlarged view of the junction.

When your destination is reached, voice and visual confirmation is given.

## POINTS OF INTEREST

To set a POI as destination or a waypoint, see **Points of Interest (POI)** on page 38.

# Destination Entry

## ZIP CODE

Enter the zip code of your waypoint or destination from the keypad. Ensure that any spaces and punctuation is as used in reality otherwise the system may not find it.

When the zip code has been entered, touch **OK**.

## MAP

After selecting map, the local area map is displayed. If the destination or waypoint is not shown on the map, use the zoom button to increase the area. By using your finger on the touch-screen move the circle to the area for your destination or waypoint, zooming in if required.

This location can be stored as a destination or waypoint.

Touch **OK**.

## COORDINATES

If you know the coordinates of your destination they can be entered from this screen. The full latitude must be entered first before the longitude coordinates can be entered.

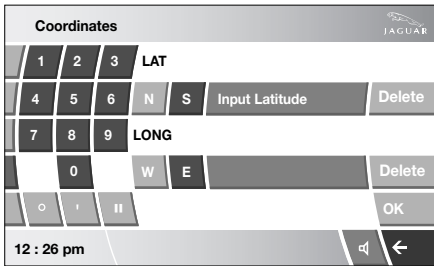

The screenshot shows the 'Coordinates' entry screen. At the top, it says 'Coordinates' and has the Jaguar logo. Below is a keypad with numbers 1-9 and 0. The 'LAT' label is positioned above the numbers 1, 2, and 3. The 'LONG' label is positioned above the numbers 7, 8, and 9. The keypad also includes directional keys 'N', 'S', 'W', and 'E', and a 'Delete' button. At the bottom, there is a status bar showing '12 : 26 pm', a speaker icon, and a back arrow. The text 'JOL4564NAS' is visible at the bottom left.

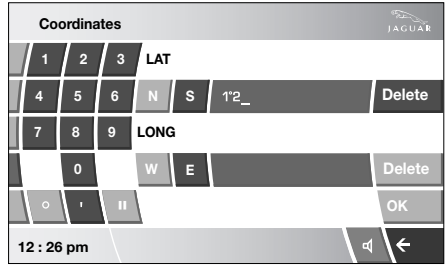

The screenshot shows the 'Coordinates' entry screen. At the top, it says 'Coordinates' and has the Jaguar logo. Below is a keypad with numbers 1-9 and 0. The 'LAT' label is positioned above the numbers 1, 2, and 3. The 'LONG' label is positioned above the numbers 7, 8, and 9. The keypad also includes directional keys 'N', 'S', 'W', and 'E', and a 'Delete' button. At the bottom, there is a status bar showing '12 : 26 pm', a speaker icon, and a back arrow. The text 'JOL4565NAS' is visible at the bottom left.

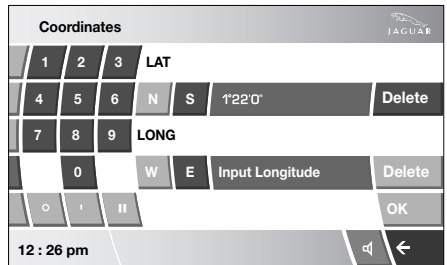

The screenshot shows the 'Coordinates' entry screen. At the top, it says 'Coordinates' and has the Jaguar logo. Below is a keypad with numbers 1-9 and 0. The 'LAT' label is positioned above the numbers 1, 2, and 3. The 'LONG' label is positioned above the numbers 7, 8, and 9. The keypad also includes directional keys 'N', 'S', 'W', and 'E', and a 'Delete' button. At the bottom, there is a status bar showing '12 : 26 pm', a speaker icon, and a back arrow. The text 'JOL4566NAS' is visible at the bottom left.

When the coordinates have been entered, touch **OK**.

If the coordinates entered are not contained within the area DVD a message will be shown. This can also occur if the incorrect coordinates have been entered.

# Destination Entry

## MEMORY

### Points of interest (POI)

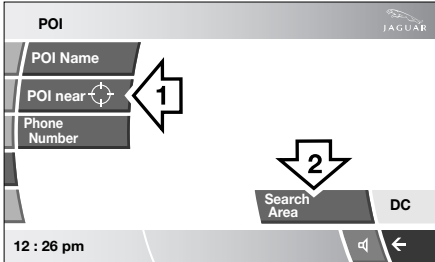

JOL4567NAS

Select **POI**, **POI Near (1)** or a **Search Area (2)** from the Destination menu screen .

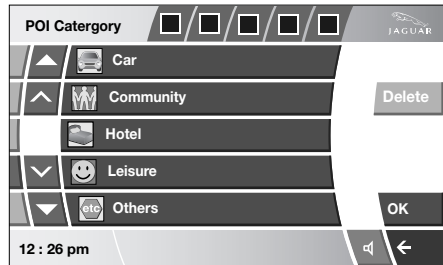
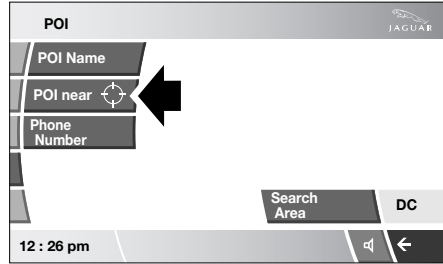

JOL4570NAS

Select the POI name, or select a search area such as a city centre to find the selected POI.

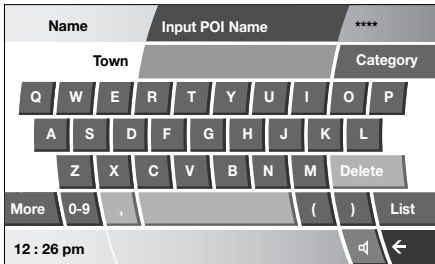

JOL4568NAS

Input the POI name using the keypad or select **List** to see the complete list of POI's.



# Destination Entry

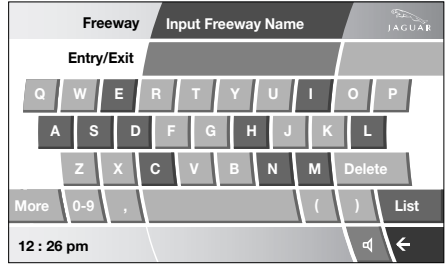
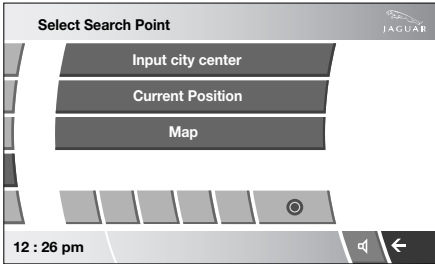

JOL4552NAS

Enter the freeway name or number.

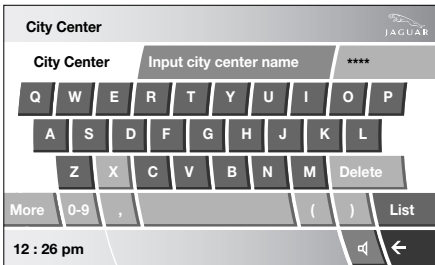

JOL4569NAS

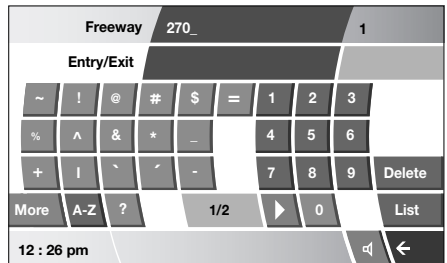

JOL4553NAS

## PREVIOUS

After selecting **Previous** from the menu, the screen shows a list of stored previous destinations. Select your destination and the details are displayed for confirmation.

**Note:** *Whilst driving, list scrolling is not active. You can only choose from the items shown at the top of the list.*

## FREEWAY

This enables you to select a freeway exit or entrance as a destination or as part of a route itinerary.

From **Destination Entry** select **Freeway Entry/Exit**.

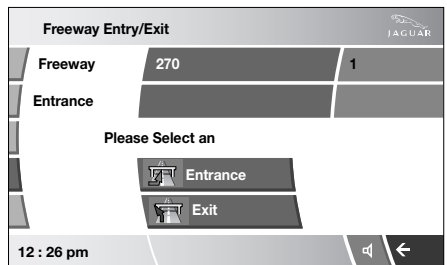

JOL4554NAS

Now select an entrance or exit.

# Destination Entry

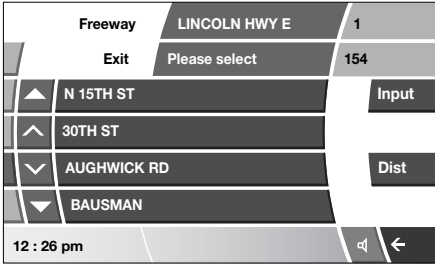

JOL4555NAS

The screen gives all of the entrance or exit junctions on the freeway.

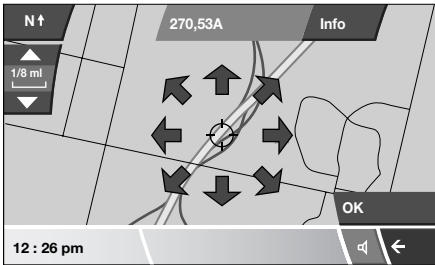

JOL4556NAS

The map showing the selected freeway and the selected exit junction is displayed.



JOL4557NAS

The destination has now been set and the route is calculated.

# Compass

## COMPASS

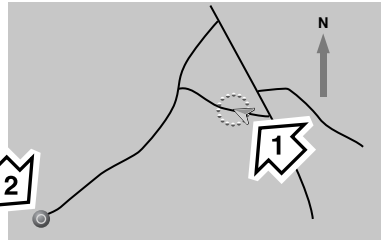
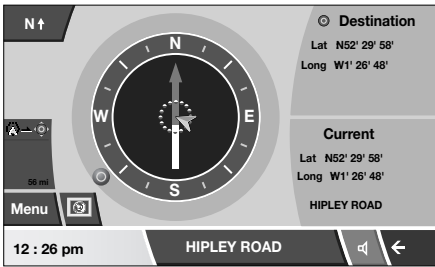
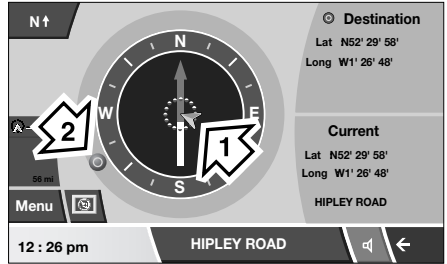
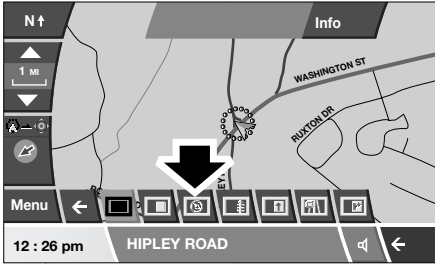

JOL4572NAS

JOL4571NAS

Select the compass icon and the compass will be displayed.

The illustration above shows the map display always facing North. The car (1) position faces its compass direction of travel and item (2) is the destination or next waypoint.

# Compass

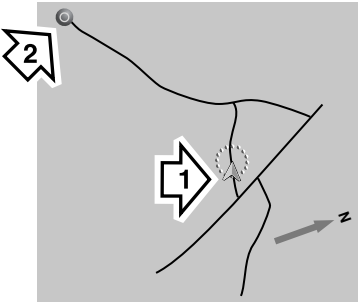
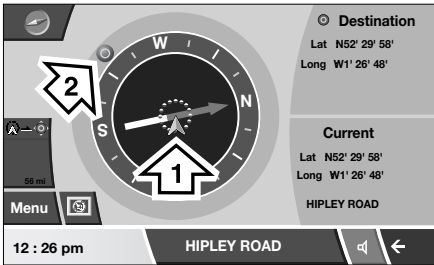

JOL4573NAS

In this illustration the car (1) position faces upwards to the top of the map and item (2) is the destination or next waypoint.

# Route Options

## ROUTE OPTIONS SELECTION

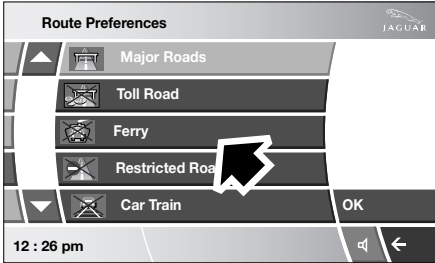

Major Roads



Toll Roads



Restricted Roads



Car Train

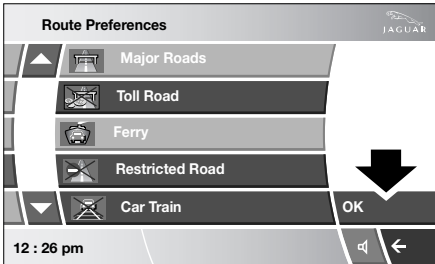

In Process Data (Details are not on the Navigation DVD)

JOL4574NAS

Refer to page 13 for setting a route preference.

Choose any of the following:



Border Crossing



Ferry



Congestion Charge

# Points of Interest (POI)

## INTRODUCTION

The Navigation System DVD contains information about a large number of points of interest (POI). There are many categories of POI, including gas stations, restaurants, railway stations and hospitals.

This chapter explains how to select a specific POI. A selected POI can be set as a destination.

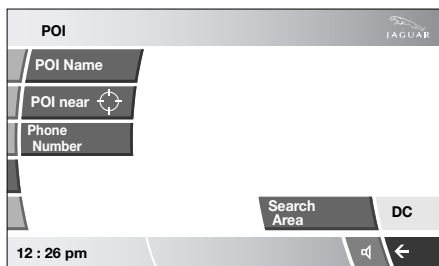

JOL4584NAS

From the **Destination Entry** menu, select **POI**.

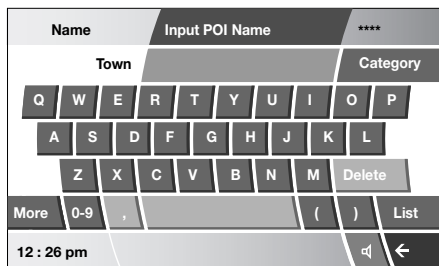

JOL4585NAS

Input the POI name, for example Gas to display gas stations on the map, or touch **List** for a list of POI's.

**Note:** If entering a POI name results in too many matches being listed, try entering the town name first. If you do not know the name of the POI you want, try selecting a POI category.

Alternatively, chose **POI** to see all categories of POI and make your selection.

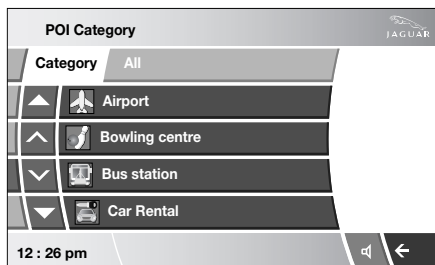

JOL4586NAS

Use the scroll arrows to change pages.

Some POI's are sub-categorised. As an example, selecting **Community** will be further divided into:

- Community Centre.
- Exhibition Centre.
- Hospital.
- Park & Recreation.
- Town Hall

For details of all POI icons, see **List of icons** on page 40.

When the appropriate POI has been selected, the system begins to search for a route to that POI.

**Note:** POI icons can only be displayed up to the ½ mile (1 km) zoom level.

# Points of Interest (POI)

For this example choose **Gas Station** and **3D GAS**.

The map screen showing the destination details and route settings is displayed.

## POI ICON DISPLAY

After selecting a category, the map display shows the location of each POI in the selected category, indicated by the appropriate POI icon.

For information about a particular POI, touch the desired POI icon.

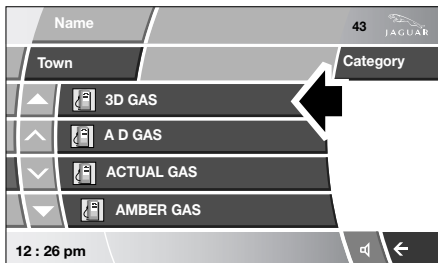

JOL4587NAS

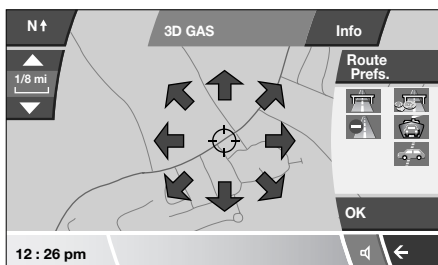

JOL4588NAS



JOL4589NAS

Once the POI has been selected the route is determined. Touch **Route Prefs.** to change the route settings, see page 30, or touch **OK** to start the route calculation.

# Points of Interest (POI)

---

## List of icons

### Shopping



Shopping Centre



Grocery Store

### Travel



Rental Car Agency



Train Station



Airport



Bus Station



Ferry Port



Rest Area



Hotel



# Points of Interest (POI)

---



Bank



ATM

## Automotive



Automobile Club



Auto Service & Maintenance



Gas Station



Jaguar Dealer



Parking

# Points of Interest (POI)

---

## Community



Community Centre



Exhibition Centre



Hospital



Park & Recreation



Town Hall



Historical Monument



Museum



Theatre



Town Centre



University/College

# Points of Interest (POI)

---

## Leisure



Bowling Centre



Casino



Cinema



Golf Course



Ice Skating Rink



Music Club



Ski Resort



Sports Centre



Tourist Attraction



Vineyard

# Points of Interest (POI)

---

## Restaurant



All Restaurants



Chinese



Fast Food



French



Italian



Japanese



Other Restaurants

# Points of Interest (POI)

---

## CANCELLING POI ICON DISPLAY

If the display of POI icons is no longer required, they can be turned off as follows:

- Touch the map screen to display the additional buttons.
- Touch **POI Off** to cancel the display of POI icons on the map.

## JAGUAR DEALERSHIP LOCATIONS

Details of Jaguar Dealerships are held on the Navigation System DVD as a points of interest (POI) category. Certain Dealers may be located in areas that are not fully mapped on the DVD. If a route is set to one of these Dealers, guidance will only be possible to the nearest town centre; a warning message will be displayed.

If Jaguar Dealerships (or certain other categories, such as airports) are selected, they will be displayed across all search areas.

## ENTRY BY TOWN

If a town name is entered first, the points of interest listed will be restricted to that town.

- From the Input POI Name screen, touch **Town**.
- Enter the town name required.
- Touch **List** to display the list of possible towns.
- Select the town required.

The Input POI screen is displayed again.

- Enter the POI name required.

## ENTRY BY CATEGORY

If a POI category is selected first, the points of interest listed will be restricted to that category.

## OTHER SELECTION METHODS

The previous examples show the three basic methods of searching the POI database, i.e. POI name only, town before POI name, and category before POI name.

### Town centres

The POI database holds town centre locations. To select a town centre, proceed as follows:

- From the Input POI Name screen, enter the town name required in the **Name** text area. (Do not select the **Town** button.)
- Touch **List** to display the list of matches.
- For the town centre, select the entry showing the town name only.

The map is displayed showing the town centre location.

**Note:** *In some cases, more than one town centre location may be listed.*

## CATEGORIES AND SUB-CATEGORIES

The POI database is divided into a number of categories. Each main category is further divided into a number of sub-categories.

The first entry in the list of Restaurant sub-categories, is **ALL**. This selects all of the Restaurant sub-categories.

# Points of Interest (POI)

To narrow the search, touch the **Town** button. This will display the alpha keyboard, to allow the desired town name to be entered.

## Search area

When searching the database, only points of interest in the current search area are included, except for the sub-categories marked **All Search Areas** in the POI category list.

## List button

The **List** button becomes active, when the characters entered reduce the possible entries to a small enough number. (The list is displayed automatically when the number of entries reduces to four or less.)

You can also select **List** (when active) without entering a POI name. All the relevant points of interest will be displayed, e.g. in a selected town or category.

## All button

The **All** button returns to searching all categories after selecting one category.

## POI ENTRY MESSAGES

While searching for points of interest, you may encounter one of the following messages:

1. **There are no POI's in this Category.**
2. **No POI's found in this Town.**

## QUICK POI SELECTION

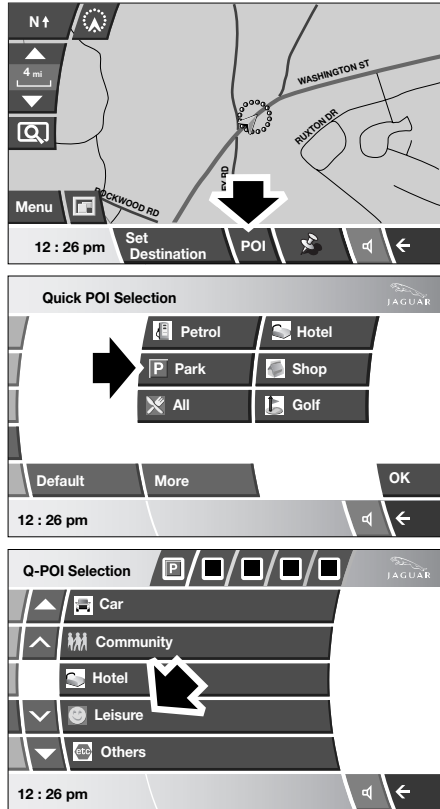

JOL4508NAS

A total of six POI's can be stored.

## Changing the Quick POI Categories

The six default Quick POI categories can be changed as required.

- At the Map screen, touch anywhere on the map.
- Touch the **POI** button.
- Select the Quick POI category that you wish to replace.

# Points of Interest (POI)

---

The screen shows the full list of POI categories.

- Select the new category required from the list.

The screen shows the new selection of category icons.

- Repeat for another category icon if required.
- Touch **OK** to apply the new settings.

## SELECTING A QUICK POI CATEGORY

- Touch the Initial Map screen, then touch the POI button. The screen shows the six categories currently selected for quick points of interest.

**Note:** *The POI button will not be active if the zoom level is below 1 km (½ mile).*

- Select a Quick POI category.

The map screen is displayed with POI icons.

### Other categories

You can also select from the complete list of POI categories.

- Touch **List Categories** and select a category from the list displayed.

### Local POI search

This selects the points of interest in all categories within 32 kilometres (20 miles) of the vehicle.

- Touch the **All Local POI's** button.

## MEMORY POINTS

The procedure for using memory points is functionally the same as for using the Quick Points of Interest.

The map display shows the location of all stored memory points in view.

- For information about a particular memory point, touch the desired memory point icon.

After touching the memory point icon, the name of the selected memory point is displayed at the top of the screen.

**Note:** *Unlike POI's, memory points are displayed at all zoom levels.*

### Memory point details

- Touch **Info.** to display the details of the selected memory point.

The details include Icon, Name, Position and Tel.

The telephone number can be called by touching the telephone button, if a Jaguar telephone is fitted.

The memory point details can be edited.

## CANCELLING ICON DISPLAY

If the display of Memory Point icons is no longer required, they can be turned off as follows:

- Touch the map screen to display the additional buttons.
- Touch **Nav Menu.**
- Touch **Display Options.**
- Touch **Map Options.**
- Touch **Memory Point Hide** to cancel the display of icons on the map.

# End User Licence Agreements

---

## **ORDNANCE SURVEY DATA**

Please read this agreement carefully before using the Navigation System.

This is a licence agreement to use the Ordnance Survey (OS) Code-Point data incorporated in the Navigation System. By using this Code-Point data you accept and agree to all the terms and conditions below.

### **Ownership**

The OS Code-Point data is licensed by Ordnance Survey with permission of Her Majesty's Stationery Office.

© Crown Copyright. All rights reserved.

### **Licence grant**

OS grants you a non-exclusive licence to use your copy of the OS Code-Point data for your personal use solely as part of the Navigation System. You may transfer the licence to a subsequent purchaser of the vehicle with which the Navigation System is supplied, provided that the purchaser agrees to abide by each of the terms of this licence.

### **Licence Terms**

These licence terms are governed by English Law and are subject to the exclusive jurisdiction of the English courts.

### **Limitations of use**

The OS Code-Point data is restricted for use in the specific system for which it was created. Except to the extent explicitly permitted by mandatory applicable laws, you may not extract or re-utilise any part of the contents of the OS Code-Point data, not reproduce, copy, modify, adapt, translate, disassemble, decompile, or reverse engineer any portion of the OS Code-Point data.

### **Limitation of liability**

Ordnance Survey does not warrant or represent that any of the Code-Point data is accurate, error-free or suitable for your purposes. In no event shall OS or the supplier of the Navigation System using the OS Code-Point data be liable for any consequential, special, incidental or indirect damages for any direct or indirect loss of revenue, profits, business, data, or use, incurred by you or any third party arising out of your use of the OS Code-Point data, whether in an action in contract or tort (including negligence and breach of statutory duty) or otherwise, even if OS or the supplier of the Navigation System has been advised of the possibility of such damages. In any event, OS's liability for direct damages is limited to the price of the copy of the OS Code-Point data. Nothing in these licence terms shall operate to exclude or limit any liability which cannot be excluded or limited by law.



# End User Licence Agreements

---

THE DISCLAIMER OF WARRANTY AND LIMITATION OF LIABILITY, SET FORTH IN THIS AGREEMENT, DO NOT AFFECT OR PREJUDICE YOUR STATUTORY RIGHTS WHERE YOU HAVE ACQUIRED THE DATABASE OTHERWISE THAN IN THE COURSE OF A BUSINESS.

# End User Licence Agreements

---

## **NAVTEQ CORPORATION**

Please read this agreement carefully before using the Navigation System.

This is a licence agreement for your copy of the Navigable Map Database, (the 'DATABASE') originally made by NAVTEQ Corporation), used in the Navigation System. By using this DATABASE you accept and agree to all the terms and conditions below.

### **Ownership**

The DATABASE and the copyrights and intellectual property or neighbouring rights therein are owned by NAVTEQ Corporation or its licensors.

### **Licence grant**

NAVTEQ Corporation grants you a non-exclusive licence to use your copy of the DATABASE for your personal use or for use in your business' internal operations. This license does not include the right to grant sub-licenses.

### **Limitations of use**

The DATABASE is restricted for use in the specific system for which it was created. Except to the extent explicitly permitted by mandatory applicable laws, you may not extract or re-utilise substantial parts of the contents of the DATABASE, not reproduce, copy, modify, adapt, translate, disassemble, decompile, or reverse engineer any portion of the DATABASE.

### **Transfer**

You may not transfer the DATABASE to third parties, except together with system for which it was created, provided that you do not retain any copy of the DATABASE, and provided that the transferee agrees to all terms and conditions of this agreement.

### **Disclaimer of warranty**

NAVTEQ Corporation does not warrant or make any representations regarding, either express or implied, regarding the use or results of the use of the DATABASE in terms of its correctness, accuracy, reliability, or otherwise and expressly disclaims any implied warranties of quality, performance, merchantability, fitness for a particular purpose or non-infringement.

NAVTEQ Corporation does not warrant that the DATABASE is or will be error-free. No oral or written information or advice provided by NAVTEQ Corporation, your supplier or any other person shall create a warranty.

### **Limitation of liability**

The price of the DATABASE does not include any consideration for assumption of risk of consequential, indirect or unlimited direct damages which may arise in connection with your use of the DATABASE.

# End User Licence Agreements

---

Accordingly, in no event shall NAVTEQ Corporation or supplier of the navigation system using the DATABASE ("Supplier") be liable for any consequential, special, incidental or indirect damages, including without limitation, loss of revenue, data, or use, incurred by you or any third party arising out of your use of the DATABASE, whether in an action in contract or tort or based on a warranty, even if NAVTEQ Corporation or the Supplier has been advised of the possibility of such damages. In any event, NAVTEQ Corporation's liability for direct damages is limited to the price of your copy of the DATABASE.

THE DISCLAIMER OF WARRANTY AND LIMITATION OF LIABILITY, SET FORTH IN THIS AGREEMENT, DO NOT AFFECT OR PREJUDICE YOUR STATUTORY RIGHTS WHERE YOU HAVE ACQUIRED THE DATABASE OTHERWISE THAN IN THE COURSE OF A BUSINESS. Some states and laws do not allow the exclusion of implied warranties, so the above disclaimer may not apply to you.



## **WARNING:**

**The DATABASE reflects reality as existing before you received the DATABASE and it comprises data and information from government and other sources, which may contain errors and omissions. Accordingly, the DATABASE may contain inaccurate or incomplete information due to the passage of time, changing circumstances, and due to the nature of the sources used. The DATABASE does not include or reflect information on - inter alia - neighbourhood safety; law enforcement; emergency assistance; construction work; road or lane closures; vehicle or speed restrictions; road slope or grade; bridge height, weight or other limits; road or traffic conditions; special events; traffic congestion; or travel time.**

## **Government end users**

If the DATABASE is for a region of North America and is being acquired by or on behalf of the United States government or any other entity seeking or applying rights similar to those customarily claimed by the United States government, the DATABASE is licensed with 'limited rights'.

Utilization of the DATABASE is subject to the restrictions specified in the 'Rights in Technical Data and Computer Database' clause at DFARS 252.227-7013, or the equivalent clause for non-defence agencies. Manufacturer of the DATABASE of North America is NAVTEQ Corporation, 10400 W. Higgins Road, Suite 400, Rosemont, Illinois 60018, USA.



# Index

Cancel guidance . . . . .	16	Points of interest . . . . .	38
Compass view . . . . .	35	cancelling the icon display . . . . .	45, 47
Destination entry . . . . .	30	categories and sub-categories . . . . .	45
choosing your route . . . . .	30	entry by category . . . . .	45
coordinates . . . . .	31	entry by town . . . . .	45
map . . . . .	31	entry messages . . . . .	46
memory . . . . .	32	icon display . . . . .	39
motorway . . . . .	33	introduction . . . . .	38
points of interest . . . . .	30	Jaguar Dealerships . . . . .	45
previous . . . . .	33	list of icons . . . . .	40
setting a destination . . . . .	30	memory points . . . . .	47
start guidance . . . . .	30	other selection methods . . . . .	45
zip code . . . . .	31	selecting a quick POI category . . . . .	47
Errors in vehicle position . . . . .	18	Quick start	
General introduction . . . . .	17	getting started . . . . .	8
Keyboard layout . . . . .	9	map display icons . . . . .	5
Language selection . . . . .	8	map screen . . . . .	4
Loading the map DVD . . . . .	17	menu structure . . . . .	7
Main menu . . . . .	20	route preference . . . . .	13
Map display icons . . . . .	5	setting a destination . . . . .	10
Measurement units . . . . .	9	start guidance . . . . .	14
My places		turn voice guidance on or off . . . . .	15
destination & . . . . .	28	Route selection . . . . .	37
home . . . . .	29	Satellite signal reception . . . . .	19
memory . . . . .	26	Satellite signals . . . . .	18
Navigation		Setting avoid points . . . . .	28
digitised area . . . . .	18	Stored locations . . . . .	26
Navigation overview		destination/waypoint . . . . .	28
end user agreement . . . . .	48	home . . . . .	29
how it works . . . . .	18	memory . . . . .	26
loading the DVD . . . . .	17	previous . . . . .	28
Navigation setup . . . . .	21	setting avoid points . . . . .	28
calibration . . . . .	23	store a memory point . . . . .	27
language selection . . . . .	25		
quick POI selection . . . . .	22, 46		
restore system defaults . . . . .	24		
saving user preferences . . . . .	22		
user settings . . . . .	21		